

electronics

radio, communication, industrial applications of electron tubes . . . engineering and manufacture



SEPTEMBER
1939

Price
50 Cents

McGRAW-HILL
PUBLISHING
COMPANY, INC.

*Solar has perfected the tubular
paper capacitor—now it is reliable*

SOLAR

Wax-molded
Sealdtite
Tubular Paper Capacitors



**MOLDED IN HARD WAX
NO MOISTURE CAN ENTER**

The tubular type of small capacitor has offered great economy for values in fractional microfarads, but its life has heretofore been limited due to inadequate sealing in cardboard tubes. Dampness and climatic humidity have been disastrous to reliable service.

Now, the new "Sealdtite"—exclusively SOLAR—molded in hard wax and moisture-proof—brings perfection to this economical form of capacitor. Its remarkably long life recommends it for many adaptations where more expensive units have been used. **SEALED FOR SAFETY.**

*Engineering data and samples
available on letterhead request*

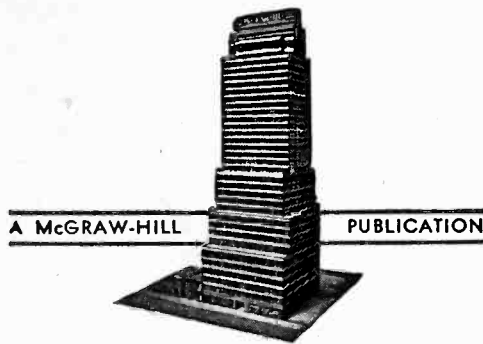

electronics

CONTENTS—SEPTEMBER, 1939

RADIO . . . COMMUNICATION AND
INDUSTRIAL APPLICATIONS OF
ELECTRON TUBES . . . DESIGN . . .
ENGINEERING . . . MANUFACTURE

KEITH HENNEY
Editor

DONALD G. FINK
Managing Editor

BEVERLY DUDLEY
Associate Editor

CRAIG WALSH
Assistant Editor

M. L. MATTEY
Assistant Editor

HARRY PHILLIPS
Art Director

H. W. MATEER
Manager

ELECTRONICS, September, 1939, Vol. 12, No. 9.
Published monthly, price 50c a copy. Subscription
rates—United States and possessions, Canada,
Mexico and Central American countries, \$5.00 a
year. All other countries, \$8.00 a year or 24
shillings. Entered as Second Class matter, August
29, 1936, at Post Office, Albany, N. Y., under
the Act of March 3, 1879.
Branch Offices: 520 North Michigan Ave., Chicago;
68 Post Street, San Francisco; Aldwych House,
Aldwych, London, W. C. 2; Washington; Phila-
delphia; Cleveland; Detroit; St. Louis; Boston;
Atlanta, Ga.

Contents Copyright, 1939, by
McGraw-Hill Publishing Company, Inc.

McGRAW-HILL
PUBLISHING COMPANY, INC.

JAMES H. MCGRAW
Founder and Honorary Chairman

Publication Office
99-129 North Broadway, Albany, N. Y.
Editorial and Executive Offices
330 West 42nd Street, New York, N. Y.

James H. McGraw, Jr., President
Howard Ehrlich, Executive Vice President
Mason Britton, Vice Chairman
B. R. Putnam, Treasurer
D. C. McGraw, Secretary
J. E. Blackburn, Jr., Circulation Manager

Cable Address:
MCGRAWHILL, New York
Member A.B.P. Member A.B.C.

CONTROLLED BY ELECTRONS.....Cover

Taylor-Winfield flash welder in the Ford Exhibit at the New York World's Fair is controlled by a Westinghouse ignitron welding timer. The duration of flow of welding current is adjustable from six cycles to forty seconds

PICTURES BY WIRE..... 13

A review of current practice in the transmission of pictures over telephone lines by the large newspicture agencies

A TELEVISION RECEIVER FOR THE HOME, by Donald G. Fink. . 16

A home television receiver design which is comparable to commercial receivers in quality and sensitivity and which can be built of commercially available parts with a considerable saving in cost

I. R. E. CONVENTION..... 23

Program of the papers to be presented at the Fourteenth Annual Convention of the Institute of Radio Engineers, Hotel Pennsylvania, New York, September 20, 21, 22, 23

THE TIME TELESCOPE, by Beverly Dudley..... 24

The rate of growth of plants, and other very slow motions, are apparently speeded up by the use of a motion picture camera and an electronic timing control unit so as to be observable in a reasonable length of time

RESISTORS AND CONDENSERS IN MASS PRODUCTION, by Herbert Chase . . 28

A word and picture trip through the plant of Erie Resistor Corp., Erie, Pa., where carbon resistors and mica and ceramic condensers are produced in large quantities

WAVE FORMS FOR HALF-WAVE RECTIFIERS, by M. B. Stout. . 32

A Fourier's series representation of the wave forms of the output voltage and current of half-wave rectifiers under varying conditions of load

COMPENSATED AMPLIFIER CHART, by Y. J. Liu and J. D. Trimmer . . 35

A graphical means of obtaining the relative values of gain and phase shift of one stage of a resistance coupled compensated amplifier

DEPARTMENTS

CROSSTALK	11
REFERENCE SHEET	35
TUBES AT WORK.....	38
ELECTRON ART	60
MANUFACTURING REVIEW	72
PATENTS	84
INDEX TO ADVERTISERS.....	92

For the HIGHER FREQUENCY BRACKETS

At the "run of the mill" frequencies radio parts designed and produced with "average" care will deliver a satisfactory performance.

But today's ultra-high frequencies demand corresponding ultra-precision parts unaffected by the vagaries typical of these frequencies. CENTRALAB Fixed Resistors have an excellent frequency characteristic less affected by voltage, humidity and frequency changes.

Again we suggest . . . SPECIFY CENTRALAB.

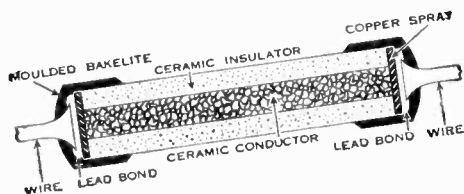

Baptized in fire at 2500 degrees—hard as stone—center ceramic core and ceramic jacket fired together to form a single shock-proof unit. Pure copper applied by Schoop metal spray process forms intimate end contact to conducting area.

Radio engineers are now tapping the resources of frequency bands formerly used only in laboratories. In order to make these bands operative parts must now be used that adhere strictly to the limitations of these bands. Centralab engineers have successfully met these problems with Centralab parts.

Centralab

DIV. OF GLOBE-UNION INC., MILWAUKEE, WIS.

AXIAL LEAD RESISTORS

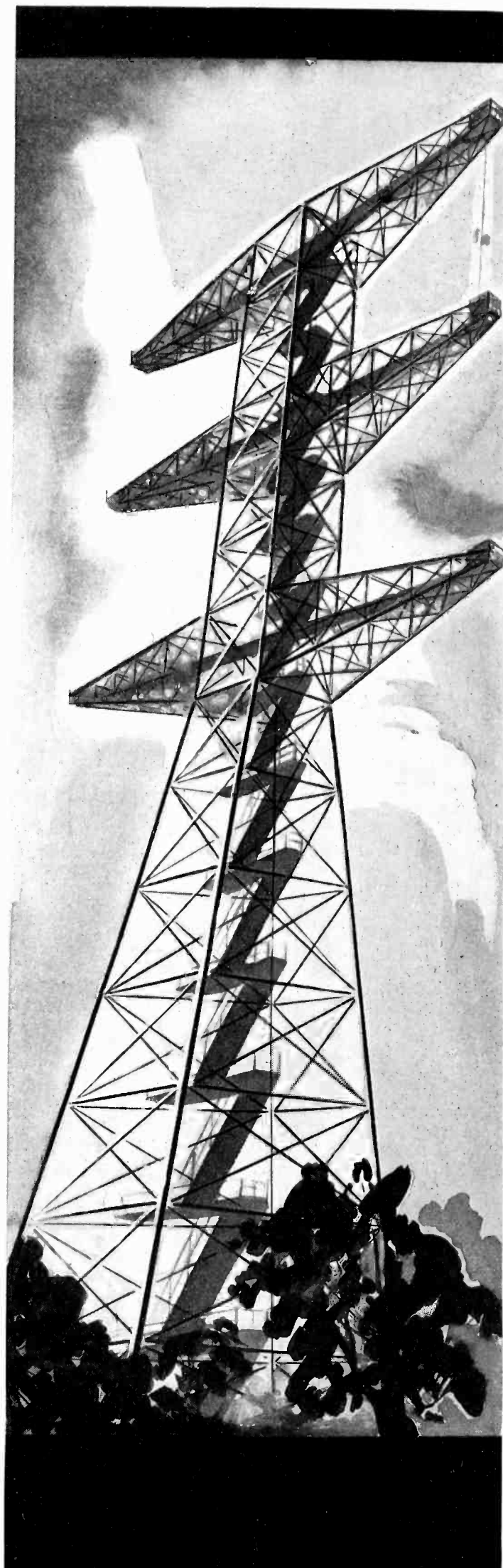

MICRO **MS** SWITCH

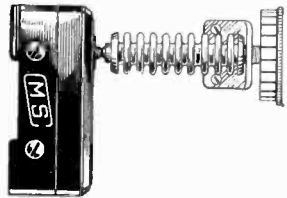

Micro Switch with regular plunger being operated by bellows type thermostat.

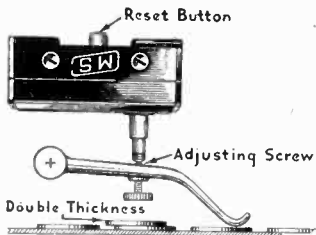

Micro Switch with special plunger as used in an adjustable thickness detector.

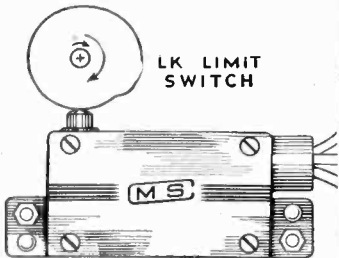

Micro Switch built into a sealed metal housing for precision service in tough spots. Cam actuated.

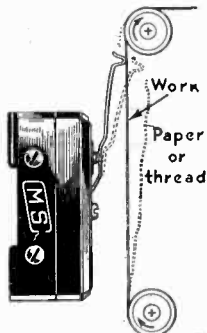

Micro Switch with snap spring actuator as a Break indicator.

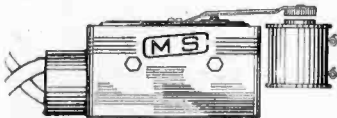

Metal-Clad Micro Switch with snap spring actuated by magnet.



Micro Switch with snap spring actuator operated by cam.



A Precision Snap Action Switch That Occupies a Space only 3/4" X 7/8" X 2" . . Operates Instantaneously Under Pressures as Low as 4 oz., with Movements as Little as .0001" . . as Many as 600 Times a Minute for Millions of Operations!

The unusually precise design, construction and the performance of this switch make its application to a wide variety of products and functions a most logical proposition. The column at the right lists some of the products on which, and functions for which, it is now being used.

Though built with watch-like precision, it will stand the constant pounding of repeated operations. Its action is lightning-fast. It has a long life—many users report from five to ten million operations. It operates in any position and is not affected by ordinary vibration. It is easily mounted with two No. 6 Screws and weighs only one ounce. It carries the reinspection label of the Underwriters' Laboratories and has the approval of the Hydro-Electric Power Commission.

It is adaptable to the following A.C. inductive motor, heater and lamp loads: 1/2 H.P. Motors, 115 to 460 volts; Heaters, 1200 watts, up to 600 volts; Lamps, 1000 watts for normally closed switches, 3 amperes, normally open switches. It can be used with a diversity of actuating mechanisms such as shown at the left.

Informative literature and data sheets, covering Standard, Super-Sensitive, and Metal-Clad Micro Switches and Micro Switch Motor Protectors will be sent you upon request. And when out-of-the-ordinary applications of the Micro Switch are involved, competent service is available.

MICRO **MS** SWITCH

MANUFACTURED IN FREEPORT, ILLINOIS BY

MICRO SWITCH CORPORATION

New York

Chicago

Boston

If you use time, temperature, pressure, weight, relay, or solenoid controlled devices or fractional H.P. motors in the manufacture of your product, you can apply the Micro Switch to advantage. It is now used on products in this partial list of classifications.

CONTROLS

Air Conditioning__ Blower and Draft__ Boiler__ Cycle Circuit__ Damper Regulators__ Electric Furnace__ Magnetic__ Pressure__ Test__ Gate Control__ Relays__ Signals__ Interlocks__

INSTRUMENTS

Flow Meters__ Fuel Indicators__ Fuel Tank Level Testers__ Humidistats__ Electrometers__ RPM Indicators__ Tickers__ X-Ray Timing Devices__

THERMOSTATIC DEVICES

Incubators__ Brooders__ Indicating__ Industrial__ Oven__ Room__

MACHINES & MACHINE TOOLS

Coin Operated__ Automatic Hobbing__ Honing__ Hydraulic Presses__ Automatic Gauging__ Bottling__ Counting and measuring__ Cutting__ Die Sinking__ Drilling__ Tapping__ Lathes__ Automatic Screw__ Milling__ Riveting__ Packaging__ Rubber Working__ Printing__ Textile__ Welding__

SAFETY DEVICES

Burglar Alarms__ Recorders__ Oil Burners__ Stop Light Systems__ Traffic Signals__ Transformer Protection__

MISCELLANEOUS

Annunciator Systems__ Counting Devices__ Direction Indicators__ Daters and Printers__ Flashers__ Cameras__ Oil Regulators__ Phonographs__ Scale Pivots__ Scale Weight Printer__ Steaming Devices__ Animated Displays__

COUPON

Micro Switch Corporation
Freeport, Ill.
Gentlemen: I am interested in the Micro Switch for.....
Please send complete information.
Name.....
Address.....
City.....State.....

ANNOUNCING...

Bakelite Polystyrene Film

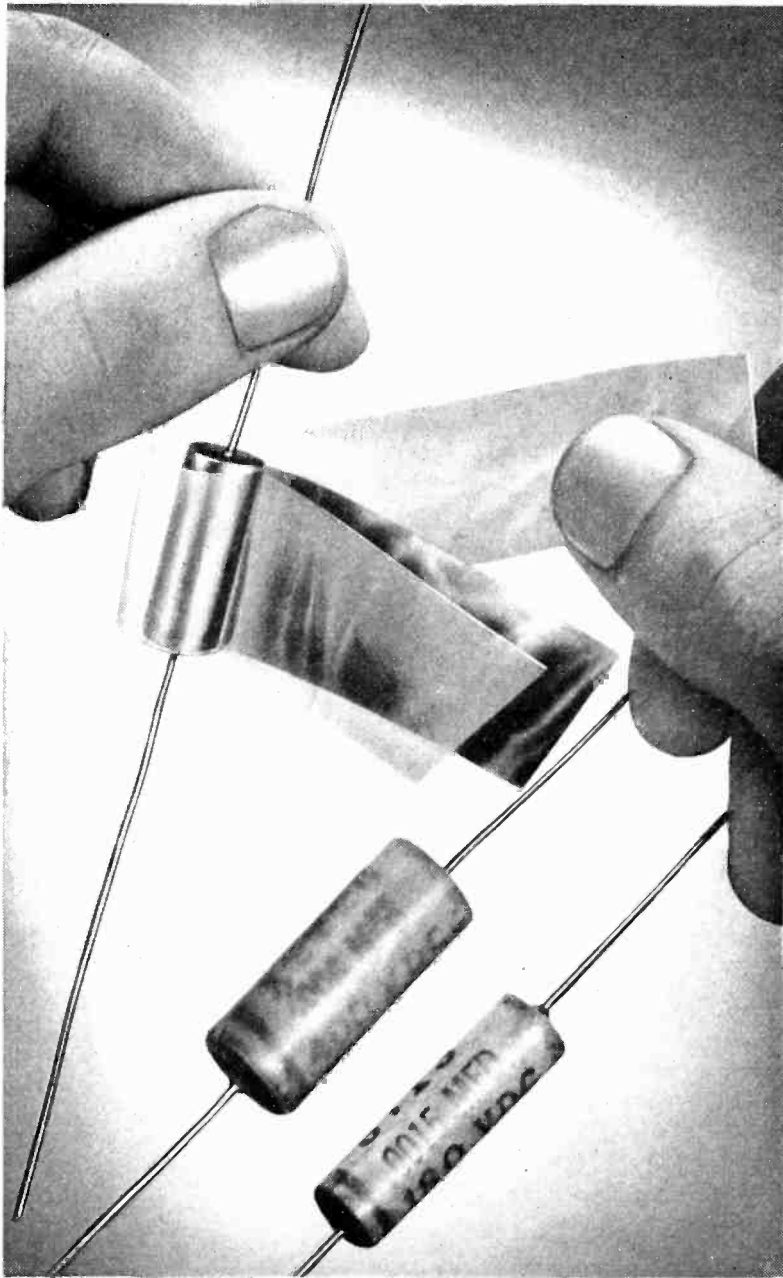

... a flexible dielectric tape that provides exceptional advantages for electronic equipment

FOLLOWING the wide success of Bakelite Polystyrene molding materials for high-frequency equipment, Bakelite Laboratories now announce another useful product made from the same unique Plastic. It is *Bakelite Polystyrene Film*... a new low-loss dielectric in thin, pliable sheet form.

Developed especially for electrical insulation purposes, Bakelite Polystyrene Film has found immediate demand for the winding of capacitors in radio sets. Its low power factor provides increased efficiency. Electrical properties will remain constant even at varying temperatures. This is made possible because of the stable characteristics of Polystyrene and its exceptional water resistance.

Bakelite Polystyrene film is supplied in either water-white or a purple-black tint. It is now supplied in $\frac{3}{4}$ " width and 1 mil thickness. Widths from $\frac{3}{4}$ " up to approximately 8" in intervals of $\frac{1}{8}$ " will soon be available in varying thicknesses.

Write for complete details, including physical and electrical properties of Bakelite Polystyrene Film. Address inquiries to Dept. 13.

BAKELITE CORPORATION, 247 Park Avenue, New York
Chicago: 43 East Ohio Street

BAKELITE CORPORATION OF CANADA, LTD., 163 Dufferin Street, Toronto
West Coast: Electrical Specialty Co., Inc., San Francisco, Los Angeles, Seattle.

VISIT THE BAKELITE EXHIBIT, HALL OF INDUSTRIAL SCIENCE, NEW YORK WORLD'S FAIR 1939

BAKELITE



PLASTICS HEADQUARTERS

LAPP GAS-FILLED
CONDENSERS
LAPP TOWER FOOTING
INSULATORS
LAPP GUY STRAIN
INSULATORS
LAPP PORCELAIN
WATER COILS

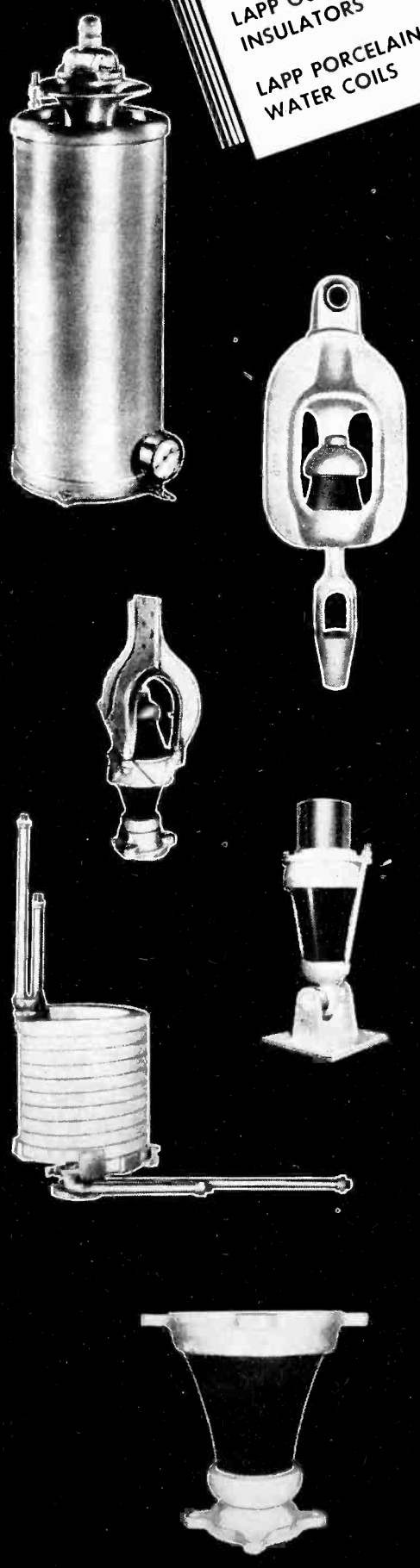

CHECK LIST

FOR RADIO ENGINEERS

CONTEMPLATING PURCHASE OF NEW TRANSMITTER EQUIPMENT

Dedicated to the cause of more efficient, trouble-free radio transmission, these Lapp specialties should be on the check list of every engineer contemplating installation of new transmitter equipment or modernization of present equipment. "Insulated by Lapp" is a phrase synonymous with operating security in radio transmission and in electrical power transmission the world over.

- LAPP GAS-FILLED CONDENSERS**
New, superior design and rigid mechanical construction in the Lapp Condenser results in genuinely trouble-free service. Maximum capacity for given external dimensions. Practically zero loss. No change in capacitance with change in temperature. Puncture-proof. Wide range of sizes for practically every transmission requirement.
- LAPP TOWER FOOTING INSULATORS**
Sectionalizing types for insulation of existing structures. Push-pull types for self-supporting radiators. Base insulators for guyed radiators up to 1000-foot height. All these base insulators utilize the Lapp patented curved-side compression cone for maximum mechanical strength.
- LAPP GUY INSULATORS**
Mast guy insulators are available in a range of sizes suitable for supporting structures up to and including 1000 feet high and 500 KW duty, for break-up duty and primary installation. Construction with the Lapp compression cone assures that porcelain be loaded only in compression.
- LAPP PORCELAIN WATER COILS**
The famous Lapp Water Coil for transmitter tube cooling, the coil that eliminated sludging in the water system. Because water used with the Lapp coil remains pure and at high resistance, tube life is increased and expense and inconvenience of changing water and replacing hose and fittings is eliminated. Alternate cooling system can be worked out with Lapp porcelain pipe, pieces and fittings of which are available for practically any requirement.

Complete descriptive literature is available on all these Lapp specialties for radio transmission. Write today.

LAPP

INSULATOR CO., INC., LE ROY, N. Y., U. S. A.

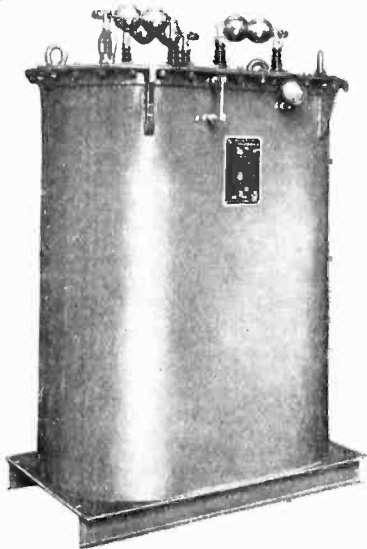

Left: AmerTran modulation transformer, oil-immersed type, for large broadcast transmitter.

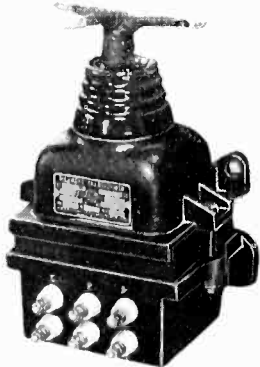

Above: Type W filament transformer, air-insulated type, for tests up to 50 Kv.

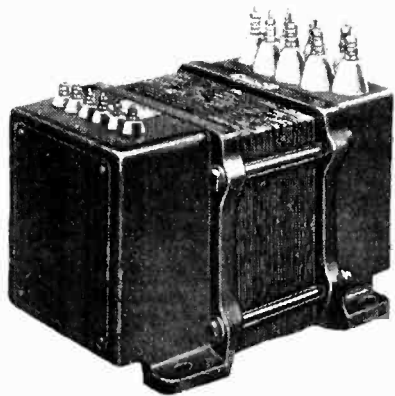

Above: Type W plate transformers and reactors for all small and medium power rectifiers.

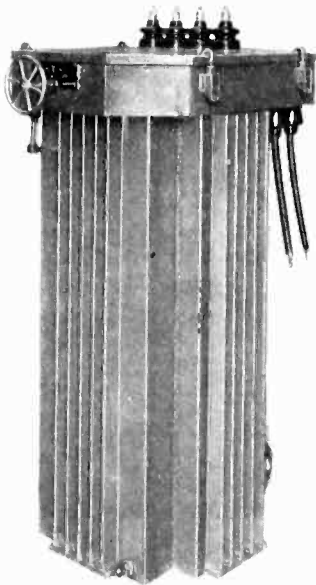

Right: Type RS plate transformers and reactors, oil-immersed type, for large rectifiers.

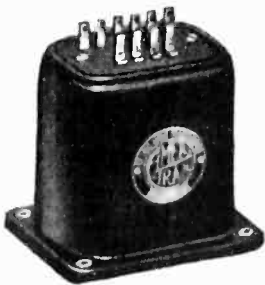

Left: AmerTran audio transformers are universally considered the "Standard of Excellence" for every amplifier application.

APPROVED

for every application
in electronic circuits

Continuous research work since the early days of radio has made and maintained the AmerTran trade-mark a symbol representing the ultimate in transformers for communication and electronic circuits. This also explains why our products are preferred by so many of the largest equipment manufacturers and best equipped broadcasting stations. Visit our booth* at the I.R.E. convention in New York and become acquainted with recent improvements in transformer design. Our engineers will be pleased to discuss your problems with you in detail.

* Booths Nos. 1 and 2, Hotel Pennsylvania, Sept. 20 to 23.



**AMERICAN
TRANSFORMER
COMPANY**

178 Emmet St., Newark, N. J.

AMERTRAN

Manufactured
Since 1901
at Newark, N. J.

TRANSFORMERS

September 1939 — ELECTRONICS

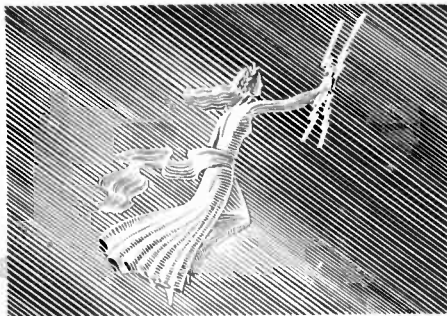

WE HAVE CROSSED THE THRESHOLD OF TOMORROW

For twenty years we here at Wholesale Radio Service Company have blazed new trails in Public Service. Scarcely a phase of the communications field has been left untouched during the years of our growth. Today thousands of discriminating buyers in every land are listed among our satisfied customers. For into every shipment we have always put more than just top-flight merchandise.

It has been this spirit of extra service that has enabled us to grow from a modest shop into a world-wide organization. We operate seven retail branches

today, with three giant central distributing points from which flow thousands of shipments daily.

As we have grown however, so too have grown the demands of the people we serve. Industry, for new and better materials; individuals, for finer instruments and forms of reception. We have lived to see many new developments replace the old, many of our former services, once essential, no longer required.

In fact, our very name for so many years perfectly adapted to our business now belongs to yesterday. It does not fit with our plans for tomorrow.

Naturally, we were attached to our old name, but sentiment has no place in progress. And so from now on we shall be known as

Radio Wire Television Inc.

A name selected because it accurately pictures the very business we are engaged in.

What do we mean? Let's look at that name more closely.

RADIO : Up through the years we have grown and expanded with Radio—very backbone of our business. Yet even in the face of today's magic, life-like reception, much remains to be done. So naturally Radio Broadcasting will continue to engage our interest.

WIRE : A new service gaining momentum with each day is WIRE BROADCASTING. Already many of today's entertainment forms are available by means of wire with great fidelity, reliability, and economy. We believe that soon the art of broadcasting by wire will encompass the transmission of both sight and sound. Every current technological development points to this end.

TELEVISION : Third and newest term in our name. Breath-taking is television's power to reproduce for man's entertainment and knowledge, the life and happenings of storied lands afar, the news events that will make tomorrow's headlines. With television a vast new field of human relationship is magically thrown open. Whichever way you choose to receive your television programs, by wire or radio, we will offer the finest services available anywhere.

The new name, thus embodies all of those features which from now on are to comprise the principal part of our business. Radio Wire Television Inc., proposes to extend its activities into every phase of the electronic art. Several associate enterprises which control important patents relating to the entire communications field have already been merged with our com-

pany. With these patents, we hope to throw open a vast number of new services to the general public. Of special interest are plans to expand the number of retail outlets for Radio Wire Television Inc. in order that local branches may be placed at the disposal of all who are interested in finer entertainment services, better products and lower costs.

Radio Wire Television Inc., is licensed by arrangement with Electrical Research Products Inc. under patents of Western Electric Company, Bell Telephone Laboratories, Inc., and American Telephone & Telegraph Company.

Radio Wire Television Inc.

formerly WHOLESALE RADIO SERVICE CO., Inc.

NEW YORK • CHICAGO • ATLANTA • BOSTON • NEWARK • BRONX, N. Y. • JAMAICA, L. I.

DU MONT experience points to NICKEL for TELEVISION TUBES



The valuable combination of properties offered by this metal results in exceptional fabricating and operating advantages

Nickel's Advantages in Television

- a. Easily formed, makes sound welds.
- b. Strength to withstand deformation during forming and at high temperatures during bombardment.
- c. Resistant to corrosion and immune to rust.
- d. Low in gas content and easily degassed at moderate temperatures.
- e. Good electron emission characteristics.

- 1 Forming and spot welding Nickel parts.
- 2 Stages in production of Pure Nickel elements for cathode ray tubes.
- 3 Sealing stem mount and Nickel parts into glass envelope.
- 4 Evacuating a 14-inch Du Mont cathode ray tube.
- 5 Securing bakelite base to tube stem and soldering connections to completed tube.

MAKERS of science's latest product are Allen B. Du Mont Television Laboratories of Passaic, N. J. Yet turning out the tube that's the heart of television is nothing new to this progressive concern. Nor is the use of Nickel.

For years Du Mont has produced oscillographs for industrial testing. Employed in these units is a type of cathode ray tube similar to that used in television. As a result, Du Mont has tried many metals, and now standardizes on parts made of Nickel. Why? Because this metal alone among many

tried offers *all* of the advantages listed above.

In addition to the cathode ray tube, Du Mont television receiving sets use 15 to 31 others... some of special design, others standard. In all of these tubes Nickel plays an important part, as it does in the tubes of other television manufacturers. Thus is Nickel fast becoming the preferred metal of Television as it is of Radio. For further information on Nickel write:

THE INTERNATIONAL NICKEL COMPANY, INC.

67 Wall Street New York, N. Y.



Here are the New STACKPOLE SLIDE SWITCHES

TYPE SS 1A

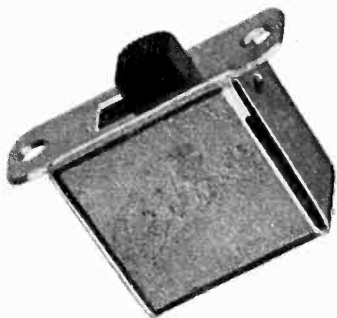

TYPE SS 1

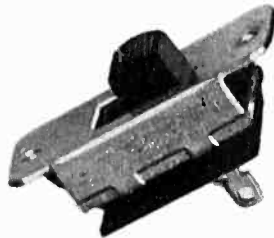

TYPE SS 3

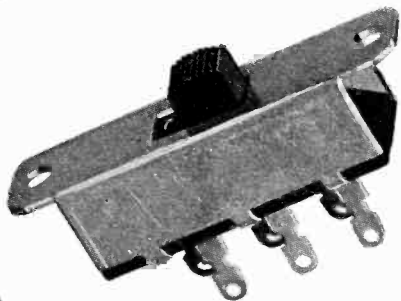

TYPE SS 3A

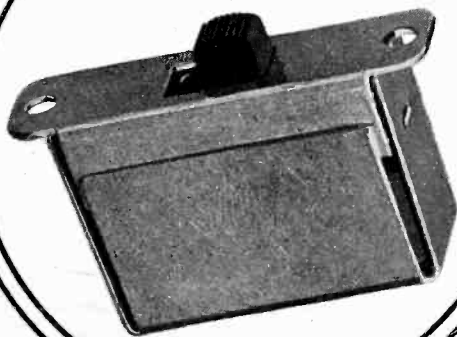

● Engineers concerned with design problems where low cost and space savings are factors will find that these compact inexpensive switches fit in exactly with their plans. The four types illustrated here have innumerable applications for handling small power circuits.

TYPE SS-1 is a single pole throw switch with Underwriters' Approval for .75 amp. 125 volts. May also be supplied with three terminals as a single pole double throw switch which is not approved by the Underwriters'. This is known as Type SS-2. These types suggest the following uses:

Two-position tone control; Sensitivity control; Change-over switch for AC-DC sets; Line switch for small sets; Small motor control; Tap switch for power transformer; Dome light switch for automobiles; Defroster motor switch; Heater-blower switch for automobile use; High-low speed switch for small motors; Battery drain control switch for battery sets; Pilot light switch for battery sets. TYPE SS-1A is identical with SS-1 except it has a snap-on shield approved by the Underwriters' as a terminal enclosure.

TYPE SS-3 is a double pole double throw switch which suggests itself for the following uses:

Change-over switch for battery-110 volt sets; Band change switch; Phono-radio switch; and many other uses. May be supplied as a double pole single throw switch known as Type SS-4.

TYPE SS-3A is identical with SS-3 except has a snap-on terminal enclosure.

WRITE FOR SAMPLES AND PRICES

All illustrations are actual size.

FIXED RESISTORS

STACKPOLE CARBON COMPANY

VOLUME CONTROLS

SWITCHES

ST. MARYS, PENNA., U.S.A.

•
TONE CONTROLS

These products are sold only to manufacturers of original equipment.

*Where Lives Depend on
the Unfailing Operation of
Transmitters and Receivers...*



P.R. MALLORY & CO. Inc. **MALLORY Vibrators are Specified**

When stormy weather clouds the pilot's vision, he must depend on his radio equipment to bring the plane safely to its destination. There can be no compromise with dependability of operation when human lives are at stake. There can be no failure . . . no delay . . . in the transmitting and receiving of messages.

Foremost manufacturers of aircraft transmitters and receivers choose Mallory Vibrators to insure unfailing operation. They have found by actual experience that only Mallory Vibrators offer all these advantages.

1. Low initial starting voltage without sacrifice of operating performance.
2. Exceedingly long life with practically no decrease in output.
3. Substantially constant reed amplitude over wide range of battery voltages.
4. Low mechanical noise.
5. Lower vibration level.
6. Permanent alignment of component parts.
7. Long life through use of highest-grade tungsten contacts.

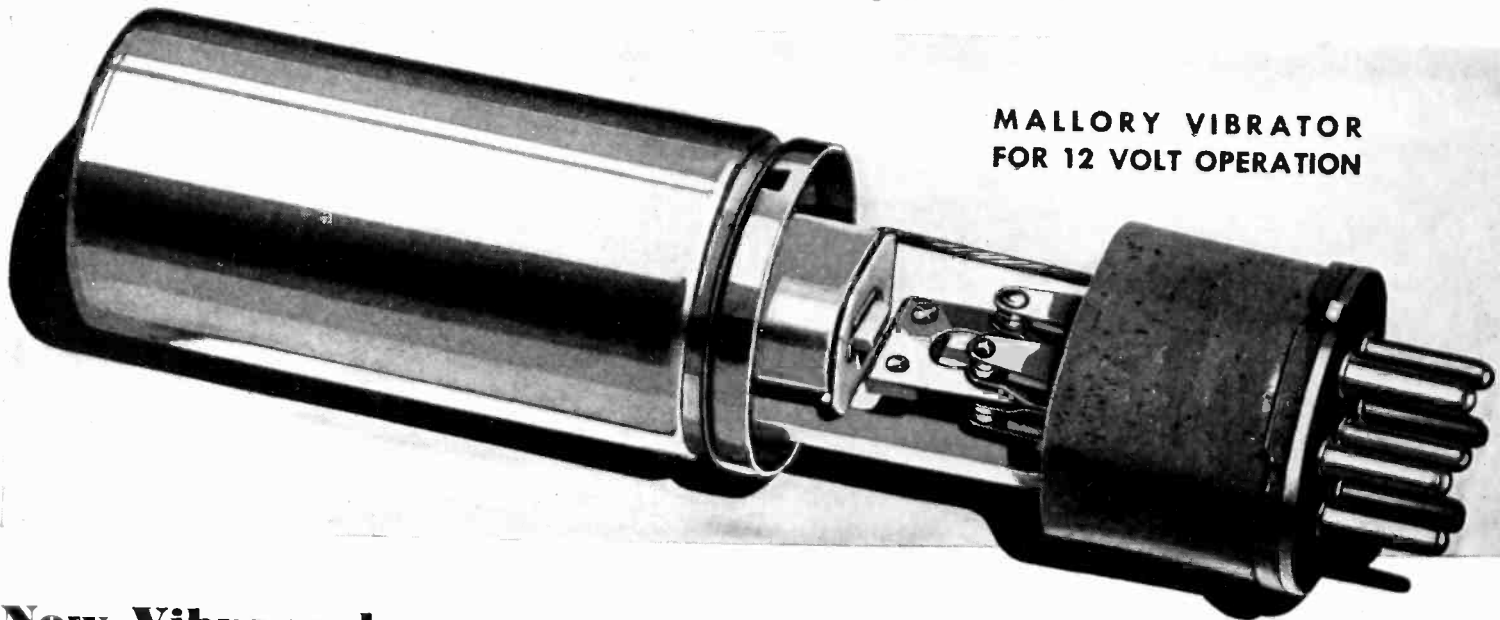

**MALLORY VIBRATOR
FOR 12 VOLT OPERATION**

New Vibrapacks—Two new dual Vibrapacks—No. VP-555 with a rating of 300 volts at 200 ma. load, 6.3 volts input, and No. VP-557 with an output of 400 volts, 150 ma. . . . have been added to the Mallory line of vibrator power supplies. Other units are available to manufacturers in production quantities for 6, 12, 24, 32 and 110 Volts, DC operation, with a single output rating over a range of 125 to 325 Volts. For general application, standard flexible-output Vibrapacks may be obtained from Mallory-Yaxley Distributors.

P. R. MALLORY & CO., Inc.
INDIANAPOLIS INDIANA
Cable Address—PELMALLO

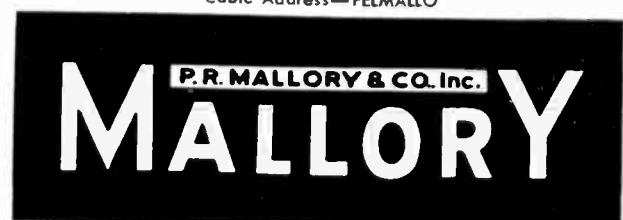



CROSS TALK

► **DEPARTURE** . . . *Electronics* has studiously avoided publication of feature articles dealing with the manufacturing processes of a single manufacturer in our industry. In this issue we depart from that plan in the instance of the article by Herbert Chase. Mr. Chase, a contributor of long standing to *Electronics*, had the unusual opportunity of learning at first hand how Erie resistors were made, and wrote for us the article published in this issue. It seems to us that there is much of interest in the ways in which things are made, including parts which go into electronic assemblies, each insignificant by itself but contributing mightily to the effectiveness of the whole. This is an experiment. If readers profit by this article others will follow.

► **CATS** . . . Sometime ago *Electronics* related the story from England of the discovery that leaks in cables could be traced by pumping a gas smelling of cats through the cable, and then running a dog up and down the outside. C. A. Briggs of Washington, D. C., thinks that he has something of use along this line. He says "What is the nature of that cat gas? Is it obtained by passing cats through gas or gas through cats? Some years ago a wood pussie found access to my basement and left a lingering reminder that needed no Labrador retriever to discover. If the cat gas is similar to my basement aromatics, is there a market for the stuff?"

► **INCIDENTALS** ASCAP (American Society of Composers, Authors and Publishers), according to NAB (National Association of Broadcasters), has a total annual revenue of approximately 6 million dollars. Of this 4 millions comes from broadcast

stations. In the last 6 years ASCAP has got from the broadcasters over 20 million dollars.

According to Dun & Bradstreet, July 22, the radio industry as of that date had sold more sets than in the same period in the previous year, but due to television publicity the sale of higher priced sets was down so that on a dollar basis 1939 to date is not so hot. Sale of time on the air, however, continues to soar. Billings for March were greater than for any month on record. The first 6 months saw total billings of more than 41 million dollars.

► **ERRORS** . . . In recent book review of Paul Deeley's book on electrolytic condensers the statement was made that this was the first book in English on the subject. Chapman and Hall, London, very properly point out that in 1937 they published "Electrolytic Condensers: Their Properties, Design and Practical Uses" by Philip R. Coursey.

Mr. Ryder, whose article on motor control circuits was published in December, 1938, *Electronics* states that in Figs. 1, 2 and 4 of that article the resistor R is improperly connected to tube B . It should be connected between grid and cathode instead of between grid and plate.

► **OBIT** . . . The world of electrical engineering suffered, in June, the loss of Dr. A. E. Kennelly whose worldwide reputation as an engineer and as a scientist is well known. The first use of complex notation applied to Ohm's Law in alternating current engineering was published by Dr. Kennelly in 1893; in 1902 he expounded his theory of the conducting layer in the upper atmosphere which has come to be known by the Kennelly-Heaviside

layer. His schedule for years had been heavy with work for the American Standards Association; his contributions to the literature of electrical engineering and to mathematical theory and his work with the professional societies had made him one of the best known and most respected of modern scientists.

► **PERSONAL** . . . Richard T. Orth, head of the receiving tube design section of the RCA plant at Harrison, N. J., was awarded one of the ten Alfred P. Sloan Foundation fellowships for a year of advanced study of industrial problems at M.I.T. He has been granted a year's leave of absence to take advantage of the opportunity.

W. J. Brown, an Englishman who has attended many IRE conventions and who has many friends among communications engineers in this country, has formed a company, The Electronic Engineering Services, Ltd., for the purpose of keeping English firms up to date on America practice, and to keep Americans aware of what is going on in England. Mr. Brown was chief engineer of the designs department of the Gramophone Co., then director of engineering of Philco Radio and Television of Great Britain and was an engineer with Metropolitan Vickers before these more recent engagements.

Vladimir Karapetoff, Professor of electrical engineering, Cornell, retired in June and has been made professor emeritus. Professor Karapetoff, it will be remembered, is not only a scientist and teacher of note but an accomplished musician as well. It was natural that he should combine his interest in electrical circuits and musical instruments in producing one of the early electrical musical devices. He holds honorary degrees of Doctor of Science and Doctor of Music.

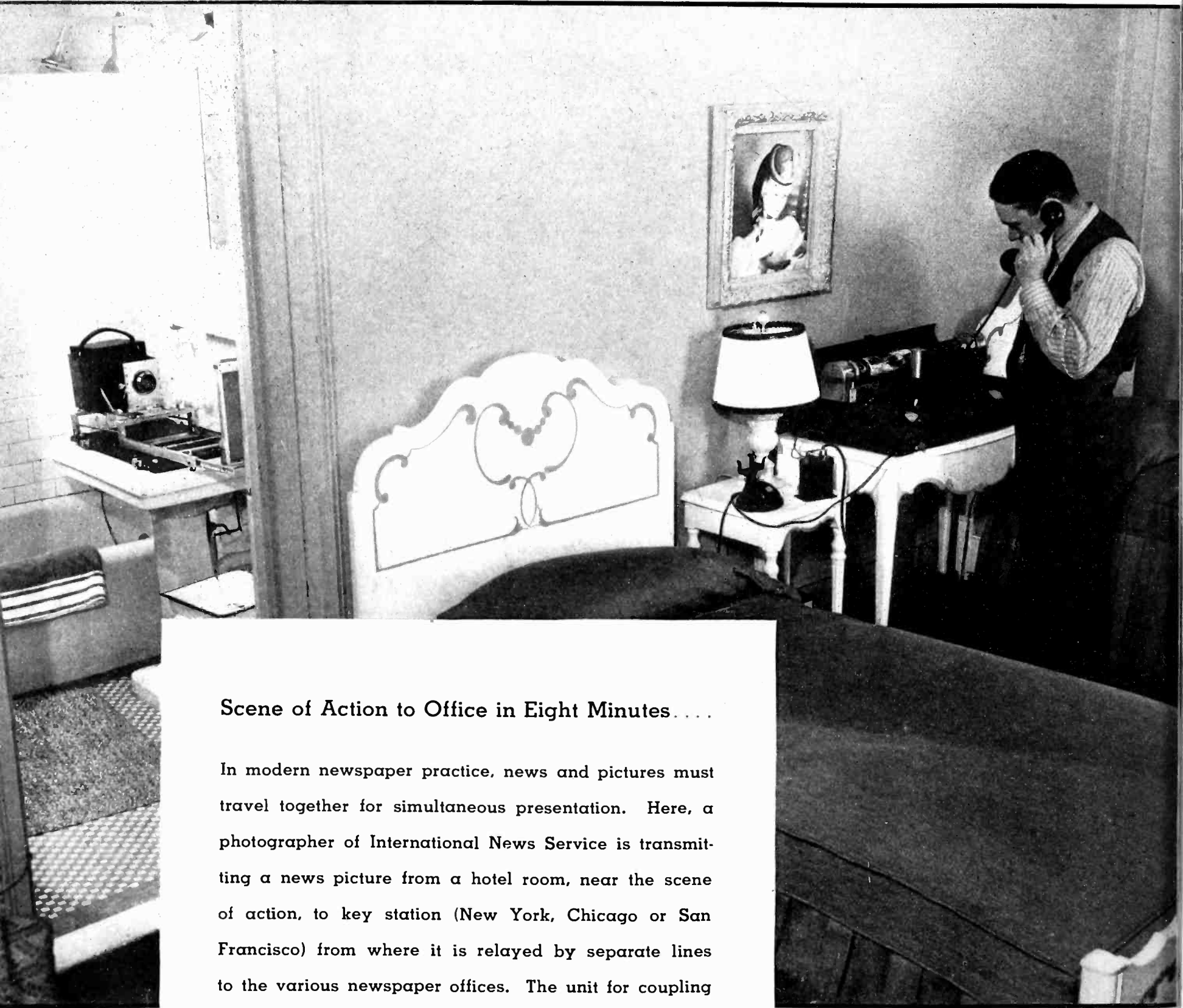

Scene of Action to Office in Eight Minutes

In modern newspaper practice, news and pictures must travel together for simultaneous presentation. Here, a photographer of International News Service is transmitting a news picture from a hotel room, near the scene of action, to key station (New York, Chicago or San Francisco) from where it is relayed by separate lines to the various newspaper offices. The unit for coupling to the telephone line is shown on the small table. The photograph has just been developed and printed in the improvised darkroom in the bath room

Pictures by WIRE



Transmitting room of Wide World Photos. Note the position of the telephone receivers on the coupling coils and the dummy receivers on the telephone hooks. These transmitters are designed to operate from the storage batteries shown under the bench

IN the past two years, although the fundamental principles of wire transmission have remained unchanged, many improvements and refinements have been made in the equipment to improve the quality of the picture, to reduce size and weight and hence facilitate the transportation of portable units, and to simplify its operation so that a photographer unfamiliar with electrical engineering can use it with full satisfaction. The same agencies, Acme News Pictures, Associated Press, Finch Telecommunications, International News Photos and Wide World Photos have continued in operation, and each has made substantial progress.

The general arrangement of the transmission systems of the different agencies is very much the same. They differ only in details of construction and operation. Each picture transmitting unit has a cylinder around which the picture to be transmitted is wrapped, a scanning head containing a light source and a phototube, and a motor drive of constant speed and each receiving unit has a cylinder around which the negative material to be exposed is wrapped, a scanning head carrying the modulated light source and a motor drive. All systems have a means of synchronizing the trans-

mitting and receiving motor drives and of properly phasing the two rotating cylinders so that the transmitted picture will be properly located on the receiving film. All of the systems transmit on a carrier frequency and therefore all contain carrier frequency oscillators, modulators, demodulators and amplifiers.

Principles of Operation

No method has yet been devised whereby more than a single piece of information can be transmitted at one time in a single circuit. Therefore, as in television, the picture must be divided into a large number of units, each of which is small enough so that it may be considered that it contains only one shade of white, black or gray. It is then possible for a phototube to "look" at each unit in turn and translate the shade of each unit into a voltage which may then be transmitted over the telephone lines. At the receiving end, the voltage is retranslated into light which is used to expose a corresponding unit on the negative film by an amount which will permit a very close reproduction of the original shade in the unit of the positive print of the transmitted picture.

In practice, wire transmission of pictures is accomplished in the fol-

lowing manner. Two cylinders of the same dimensions, one in the transmitting unit and one in the receiving unit, are located a considerable distance apart, up to 3,000 miles and more. Around the transmitting cylinder is wrapped a positive print of the picture to be transmitted and around the receiving cylinder is wrapped a negative photographic film, generally with rather high contrast emulsion. It is possible to transmit to more than one receiver at one time, but for purposes of illustration one receiver will be considered. The two cylinders are rotated at very closely identical speeds (generally about 100 r.p.m.), by means of synchronous motors controlled by frequency standards such as temperature compensated tuning forks and are in phase with each other in respect to the position of the transmitted picture and the receiving negative. As the cylinders rotate, scanning heads move longitudinally along the cylinder at the rate of about one inch per 100 revolutions, or at a scanning rate of 100 lines per inch. The transmitting scanning head contains a source of light to illuminate a small area in the picture equal in size to a scanning unit (about 1/100 inch square) and a phototube to pick up the light reflected from the illuminated area.

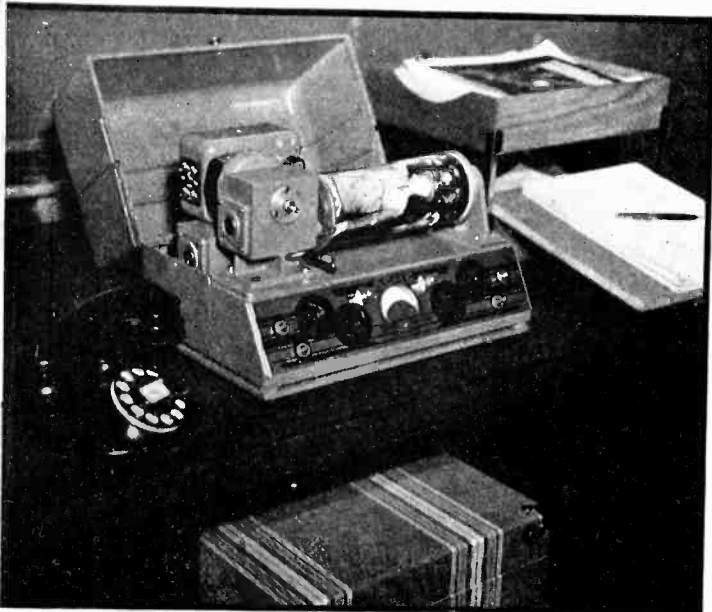

The transceiver unit, contained in two cases, of Acme News Pictures is easily carried by one man and accommodates pictures up to 7 by 9 inches in size

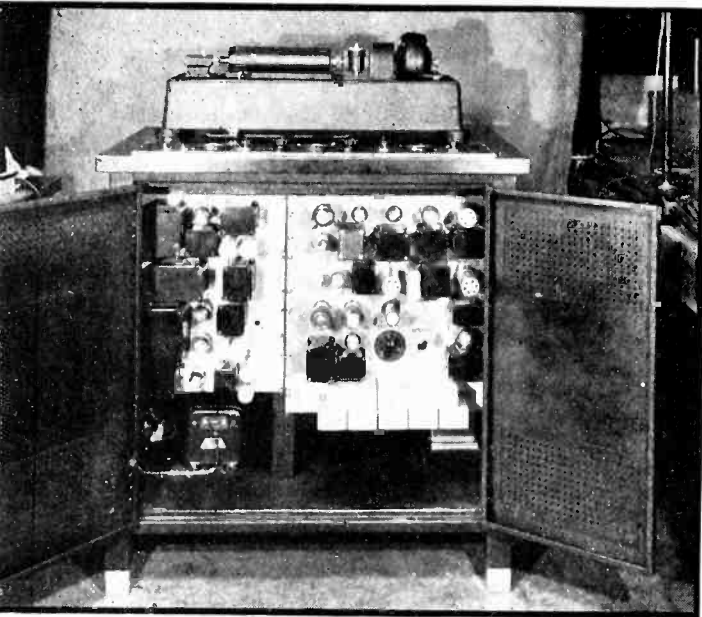

Receiving unit of the Associated Press. The drum with the negative film rotates in a light tight case to give complete daylight operation. The film is placed on and removed from the drum in a darkroom

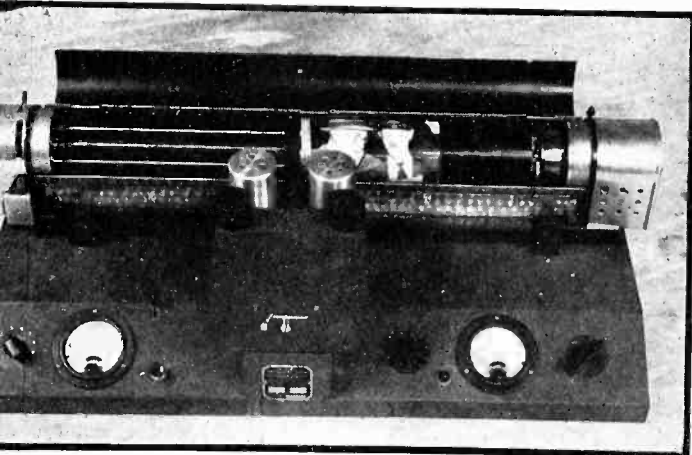

The transceiver of International News Photos can be changed from transmitting to receiving by throwing one switch located on the scanning head

The receiving scanning head contains a source of light which may be varied in accordance with the signal from the phototube pickup in the transmitter, or according to the amount of light reflected from the picture scanning unit to the phototube. The light is focused on the film in the form of the scanning unit in the original picture and that portion of the film is exposed by the proper amount.

Modulated Carrier Signal

The signal from the phototube is used to modulate a carrier frequency of about 2,000 cps. The modulated signal is amplified and fed into the telephone line by one of several methods. It may be fed through a transformer supplied by the telephone company and connected directly to the line, or it may be fed to the line by means of a coil placed in close proximity to the telephone receiver or the coils of the bell box. The signal is picked off the line in the same manner. At the receiver, the signal is demodulated and amplified. It is then fed to the light source which may be varied in accordance with the variations of the incoming signal. There are several methods of doing this. A crater lamp may be employed whose intensity varies with the applied voltage. The light may also be varied by keeping the intensity of the source constant, but varying the cross-sectional area of the light beam as it passes through the optical system. This may be done by vibrating a small galvanometer mirror, which reflects the light beam, in accordance with the voltage variations of the picture signal. The latter method is applicable to either the variable line width or variable density system of shading reproduction. The light beam is focused on an elementary area of the film and exposes the entire film by exposing one unit area after another, in the same order as the original picture is scanned in the transmitter, until the process is complete. After the completion of transmission, the film is removed from the cylinder and is developed, fixed and washed in the usual manner after which as many positive prints as desired may be made. In the developed negative or the finished print of the transmitted photograph, there will be found a large number of narrow lines which are very slightly

diagonal. They are called the scanning lines and are caused by the rotating motion of the cylinders and the longitudinal motion of the scanning heads which cause the scanning path to be in the form of a helix on the cylinder which in turn causes the path to appear as the large number of parallel, slightly diagonal lines in the finished picture. However, these lines are generally unnoticeable when the picture is printed in a newspaper.

For transmission of news pictures as quickly as possible from the scene of action to the newspaper office there have been developed a number of portable transmitting and transceiver units. They feature light weight, small size and simplicity and flexibility of operation. They are small enough to be carried in a pair of suitcases and are simple enough in operation that they may be operated with full satisfaction by a non-technical person by following printed instructions. Transmission can take place from any telephone in a hotel room, a corner drug store or a backwoods general store as long as there is power available to operate the transmitter. There exists a difference of opinion regarding the flexibility of power supply required in such units. One group holds forth that where there is a telephone, there is almost certain to be a 110 volt, ac or dc power line and designs its units accordingly. Another group says that there is undoubtedly a storage battery close to every telephone in the country and therefore designs its equipment to work from batteries as well as from a 110 volt power line. The widespread use of the automobile is responsible for the latter idea. Also, if necessary, a storage battery may be borrowed from the auto, airplane or boat which transported the equipment to the locality.

Field Telephone Connections

In field operation a coupling coil located close to the receiver or bell box of the telephone may be used to couple to the telephone line or a coupling transformer may be connected directly to the line, but in this case it is necessary to notify the telephone company so that they may make the necessary connections. In some cases when the importance of the occasion warrants it, such as the recent trans-continental trip across Canada by the King and

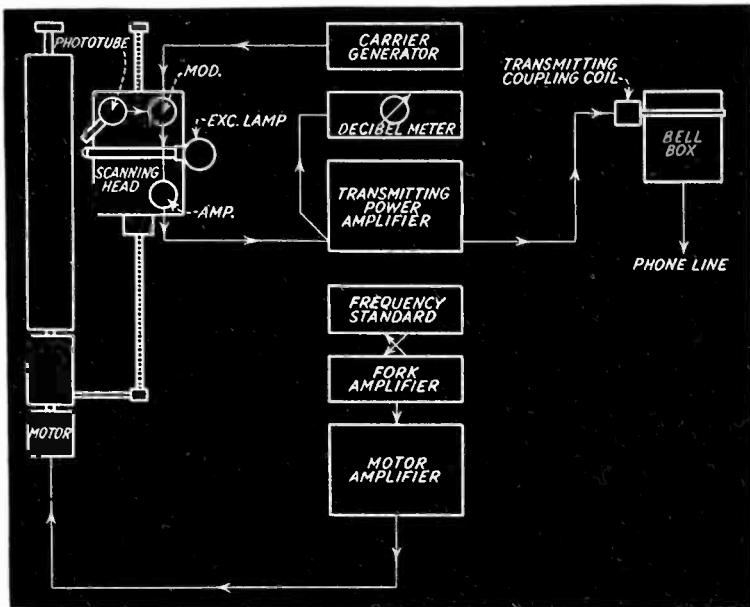

Block diagram of the Finch Telecommunications transmitter. The motor is driven by a tuning fork and power amplifier operating in constant temperature ovens

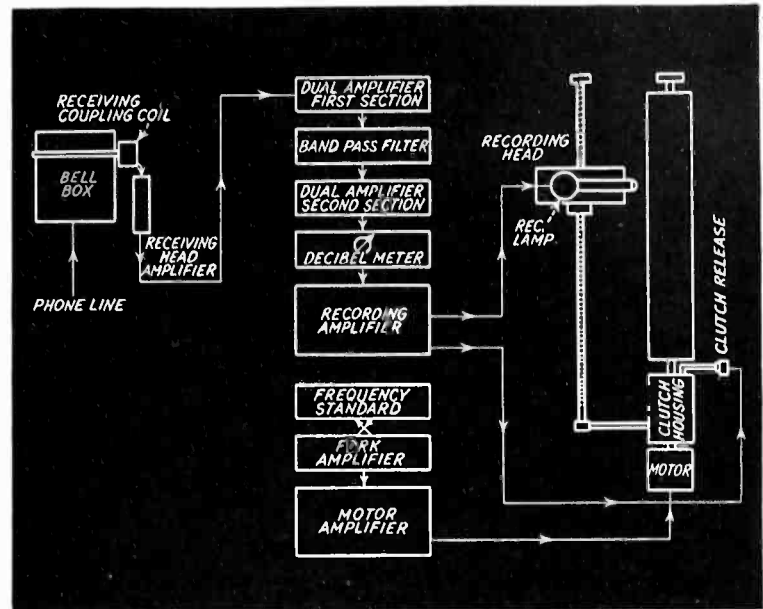

The Finch receiver uses a band pass filter to eliminate frequencies outside of the operating range which might cause unnecessary distortion of the transmitted picture

Queen of England, special telephones may be installed for the transmission of news pictures.

It is interesting to note that it is possible to transmit photographs in color as well as in black and white. It is done by transmitting the three color separation negatives separately and by the use of the proper development and dyeing technique at the receiving end.

Commercial Wire Transmission Systems

With the general background given, it is now in order to describe some of the features of the various commercial wire transmission systems. The Acme News Pictures system now consists of 27 stations located at strategic points throughout the country. It is the plan of this organization to equip each of its stations with an extra portable unit and thereby efficiently cover a considerably larger territory. The portable transceiver unit is 14 inches long, 9 inches high and 9 inches deep and weighs 28 pounds. The synchronizing and power unit for the synchronous motors is in a separate unit which measures 15 inches by 9 inches by 7 inches. Synchronization of the transmitter and receiver is obtained by sending from the transmitter an impulse once per revolution at the start of transmission. The impulse causes a neon lamp at the receiver to glow momentarily. Similarly, the receiver causes another neon lamp to glow momen-

tarily at the same point of rotation. The speed of the receiver cylinder is reduced until the two lamps glow at the same instant and the transmitter and receiver are then in synchronism. The speed of rotation of the receiver cylinder is then returned to normal. The carrier frequency is 1,800 cps and the maximum modulation frequency is 750 cps. Acme uses a coupling unit furnished by the telephone company to couple to the telephone lines.

The cylinder, or drum, which rotates at 100 rpm, accommodates pictures up to 7 by 9 inches in size. The scanning head moves across the picture at the rate of one inch per minute and scans nine square inches in one minute or a complete picture in seven minutes. The unit is designed to operate from 110 volt, 50-60 cycle power.

Leases Nation-wide Network

The Associated Press leases from A. T. and T. a nation-wide network of telephone lines over which it transmits its news pictures. The network covers approximately 40 stations in the larger cities of the country. There are also a number of portable transmitters for use by the local newspapers and for use when a story of national interest breaks within several hundred miles of a network station. The portable units are capable of operating from a variety of power sources: 110 volts ac or dc, storage battery or dry cells. A carrier frequency of 2,400

cps is used and band pass filters are used on the telephone line to pass only the carrier frequency and its sidebands and to exclude extraneous noises which would distort the picture. The cylinder on which the picture is mounted rotates at 100 rpm and is about twelve inches in circumference. The scanning rate is 100 lines per minute and therefore in one minute approximately twelve square inches of picture area are scanned.

While the detail transmitted by the present equipment with a scanning rate of 100 lines per inch is considered to be ample for present newspaper technique, the Associated Press has under development at this time equipment capable of transmitting with a scanning rate of 200 lines per inch and will give considerably more detail than is transmitted at present.

Finch Telecommunications, while not primarily interested in the commercial operation of a news picture agency, has developed a wire transmission system for such use and does at times transmit newspaper pictures. The cylinder of the Finch equipment normally operates at 100 rpm, but may be operated at 50 rpm if appreciable static which would impair the quality of the picture, is present. The carrier frequency is 2,000 cps and the upper sideband is suppressed by filters in the line which pass a band from 1,000 to 2,000 cps. The transmitter and receiver are

(Continued on page 90)

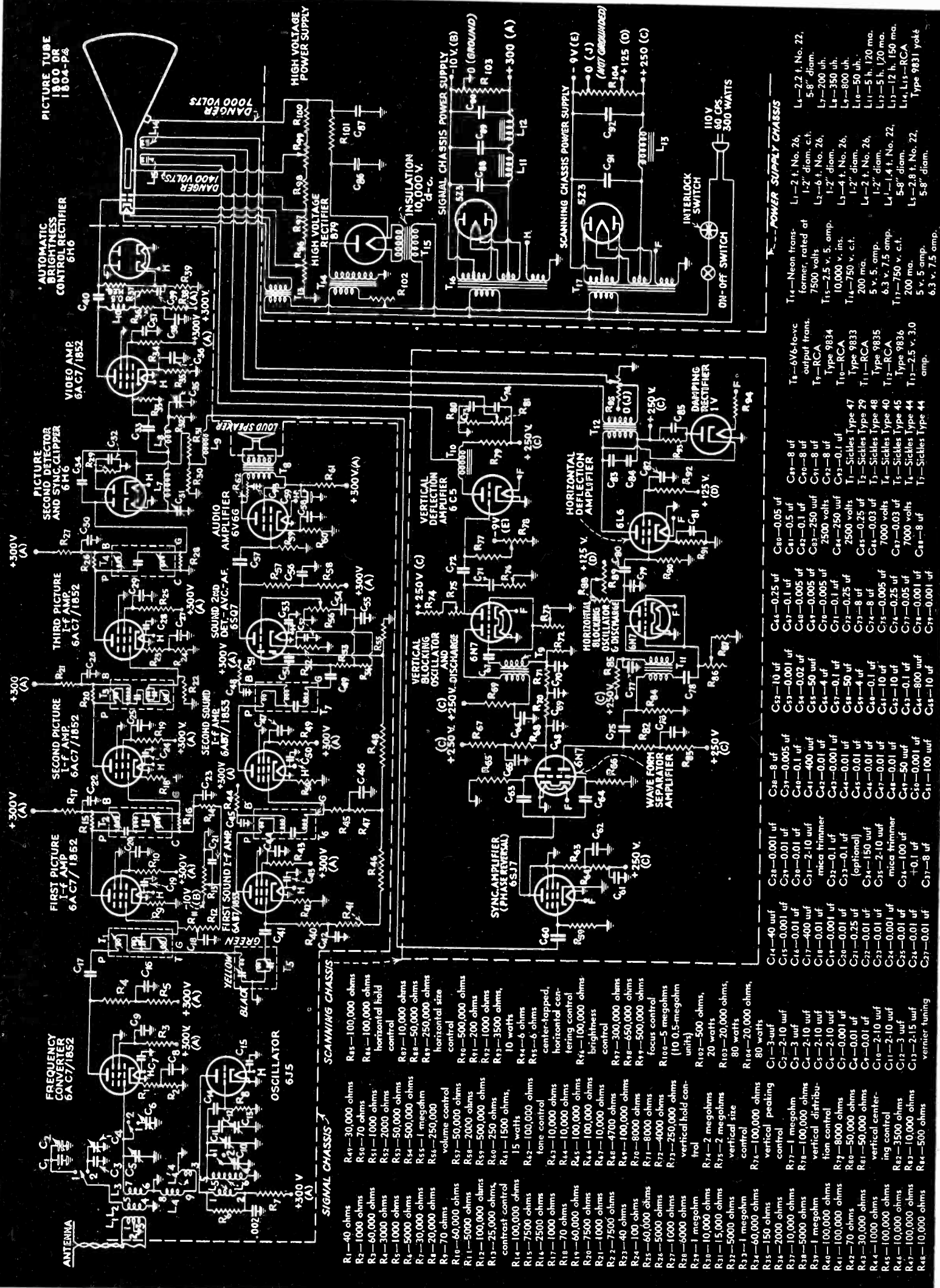

Fig. 1—Complete circuit diagram and parts list of the receiver. As long as a limited supply lasts copies of this diagram, approximately twice this size, will be furnished to readers who desire to construct the receiver

A Television Receiver for the Home

A modification of *Electronics* "laboratory" receiver, designed especially for domestic use. The new design offers performance equal to that of the better commercial receivers at considerably less cost, and it may be constructed almost wholly with standard components

By DONALD G. FINK

Managing Editor, *Electronics*

THE design of the television receiver described in this article is based on the "Laboratory Television Receiver" developed in *Electronics* laboratory in 1938, and described in the July to December 1938 issues, inclusive. When the laboratory model was completed, the author decided that its performance was sufficiently good to warrant the construction of a similar receiver for home use. Accordingly a somewhat modified design was drawn up. Since the project was a personal one, the cost had to be kept to a minimum. Actually almost 100 dollars was saved from the cost of the laboratory model by judicious cutting of corners, but in no respect was performance sacrificed to cost. The complete cost of the new receiver was \$262, including a \$50 9-inch cathode ray tube. Further savings can be effected if a 5-inch tube is used, and if the receiver is housed in a home-made cabinet (or none at all). But it is unlikely that reduction of cost below \$200 can be effected without serious losses in fidelity or sensitivity.

A second consideration in the new design was the use of components available on the market, rather than hand-made ones. Fortunately wide-band picture i-f transformers made their appearance on the market when the design was in its first stages. A considerable saving of time as well as ease of reproducing the receiver were thereby gained. Finally, the new design embraced several improvements in circuit arrangements, notably a simpler and more reliable sync-separation system, the inclusion of an automatic brightness control tube, and simplification of the controls.

The new receiver was designed, assembled and put into operation in

a total time of about 24 working days. Since completion it has been in operation in the author's home, about 10 miles airline from the NBC transmitter and somewhat below the line of sight (due to the intervention of the Palisades). For four months the receiver has given highly satisfactory performance in all respects. The signal level fed to the antenna terminals from a single dipole is about 1 millivolt, and this signal is more than sufficient to cause severe "blooming" (excess brightness) of the picture tube when the brightness control is set to the blanking level. This rough-and-ready method of estimating receiver sensitivity indicates that recognizable pictures can be obtained down

to a level of 200 microvolts, although 500 microvolts is perhaps the lower limit for satisfactory reception. In any event the sensitivity is sufficient for most locations within the service range of the transmitter, and a directional antenna is ordinarily required only at locations beyond the 25-mile radius.

The fidelity of the picture receiver, as indicated on the reproduced image of the standard NBC test chart, is between 300 and 350 lines. The upper limit in this case apparently rests in the size of the scanning spot in the picture tube, since the measured frequency response is down only 10 db at 4,000,000 cps in the video circuits. Substantially flat response is obtained

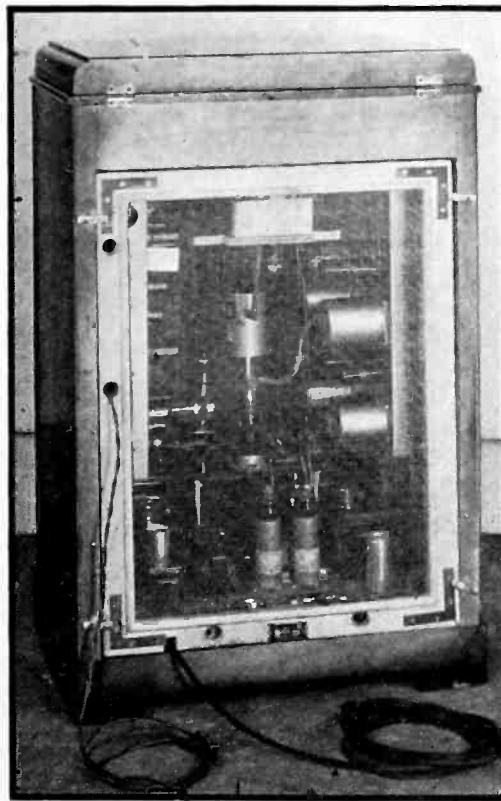
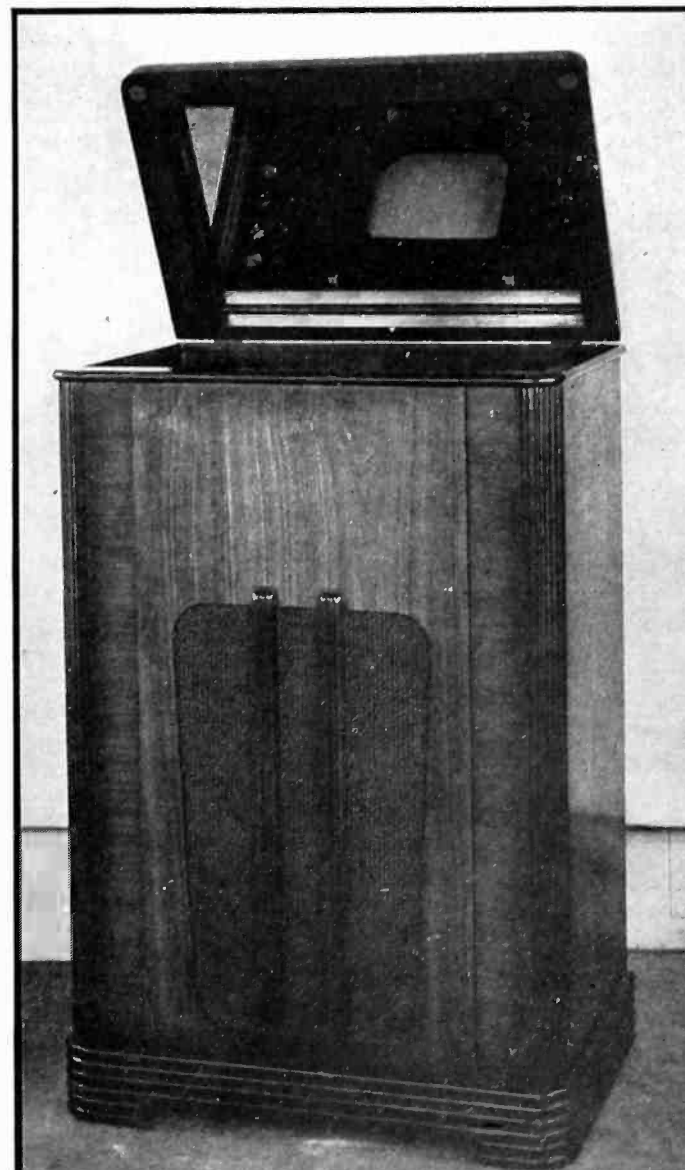

Fig. 2—Right, front view with mirror raised. Fig. 3—Above, rear view showing projective screen



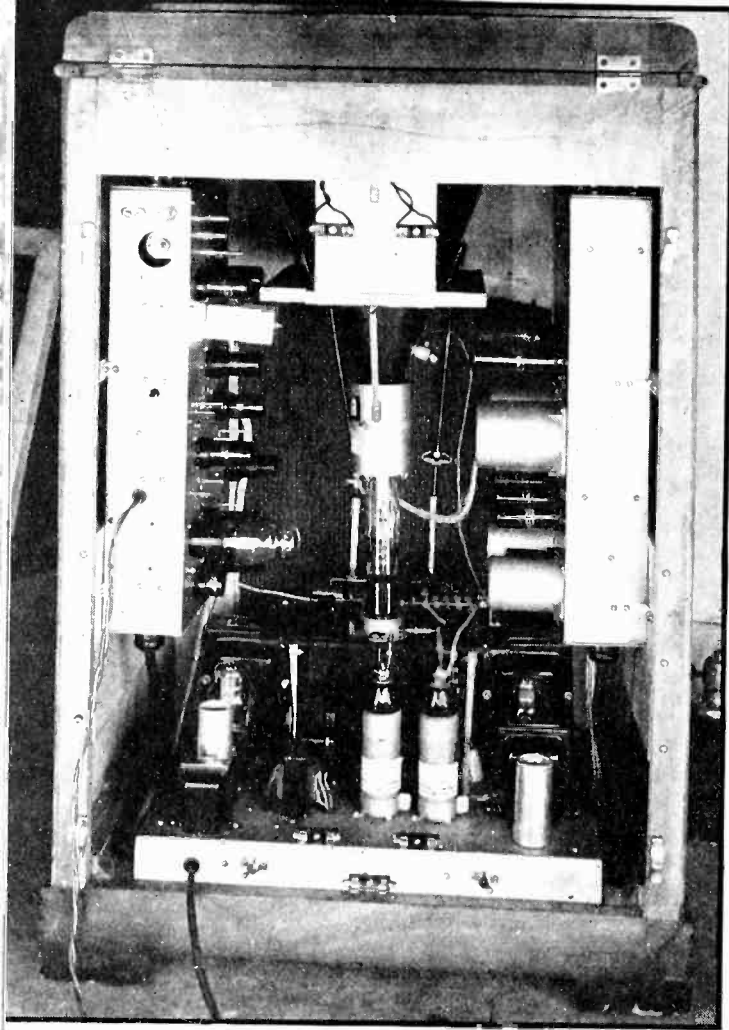

Fig. 4—The circuits are arranged in three chassis, for power supply (bottom), scanning generators (right), and signal circuits (left)

struct the receiver and derive as much satisfaction from it as from any commercial receiver of the same proportions, at roughly two-thirds the cost of the commercial product.

General Outline of the Design

The electrical details of the receiver are shown in the complete circuit diagram, Fig. 1. The tube line-up of the picture-signal circuit includes a 6AC7/1852 converter (no r-f stage), three 6AC7/1852 picture i-f stages, a 6H6 second detector and sync clipper, a 6AC7/1852 video amplifier, a 6H6 automatic brightness control rectifier, and a type 1800 or 1804-P4 picture tube. The sound channel includes two 6AB7/1853 sound i-f stages, a 6SQ7 second detector, a-v-c and a-f, and a 6V6G output stage. The sync and scanning circuits employ a 6SJ7 amplifier, a 6N7 waveform separator, a 6N7 vertical sawtooth generator, a 6C5 vertical output tube, a 6N7 horizontal sawtooth generator, a 6L6 horizontal output amplifier and a 1V damping rectifier. The power supply includes two low voltage supplies employing 5Z3 tubes, one for the signal chassis and one for the scanning chassis, and a high voltage (7000 volt d-c) unit employing an 879 tube. In all there are 23 tubes, including the picture tube.

The reader who is familiar with the "laboratory" model described last year in these pages will find many similarities and a few important differences in the new design.

In the first place, only two channels are provided for in the r-f circuits, in the interests of simplicity and low-cost and because, at present, no more than two signals are in prospect for any reception area. Additional channels may be added, readily, however. In the second place, the standard recommendations of the R.M.A. have been adopted in the picture and sound i-f channels, that is, a carrier of 12.75 Mc for the picture and a carrier of 8.25 Mc for the sound. (The double superheterodyne arrangement of the preceding design has been wisely avoided.) Otherwise the sound channel is conventional.

The video signal section differs mainly in the addition of the 6H6 automatic brightness control tube, which adds very greatly to the enjoyment of the programs, but is by no means essential to the reception of good images. The separation of the sync signals from the composite video signal is accomplished by a diode rectifier (rather than the triode of the previous design). Careful decoupling of the sync amplifier and separation circuits and the employment of a multi-element R-C filter in the vertical sync system have contributed greatly to the stability of the interlace performance of the sync circuits. When the adjustment of the circuits is correct, the interlace is maintained perfectly over periods as long as three hours (the longest consecutive period of operation thus far, during the broadcasting of the Eastern Grass Court tennis matches).

The vertical and horizontal scanning generators are essentially the same as in the "laboratory" model, with the single exception that the fine and coarse frequency controls have been consolidated into single "coarse" controls which are sufficient for the purpose. The magnetic deflection scanning yoke is the standard RCA type 9831. Two low voltage power supplies are used only because a large enough transformer could not be obtained in the standard lines to meet the current requirements of the receiver. The cost of making two supplies was thus very little more than consolidating them in one circuit. The high volt-

up to 3.5 Mc. The low frequency response, judged by the ability of the screen to reproduce "low-key" images (mostly black with small white areas) is adequate. The phase responses, audio fidelity, oscillator stability, synchronizing and scanning performance are the equal, so far as can be judged by eye, of the higher priced commercial receivers. The receiver is much less critical in adjustment than its "laboratory" predecessor and in fact can be depended upon to start operating from a cold condition and to attain synchronism at once without adjustments. Accordingly it is believed that the interested reader may con-

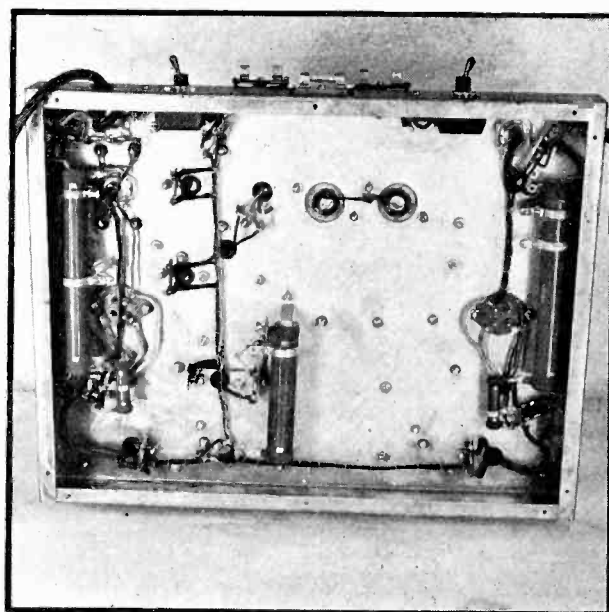
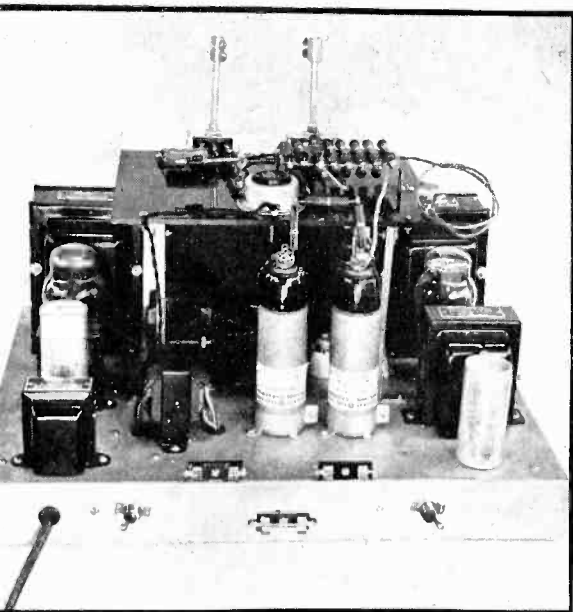

Fig. 5—Two views of the power supply chassis which contains two low voltage units and the 7000-volt supply

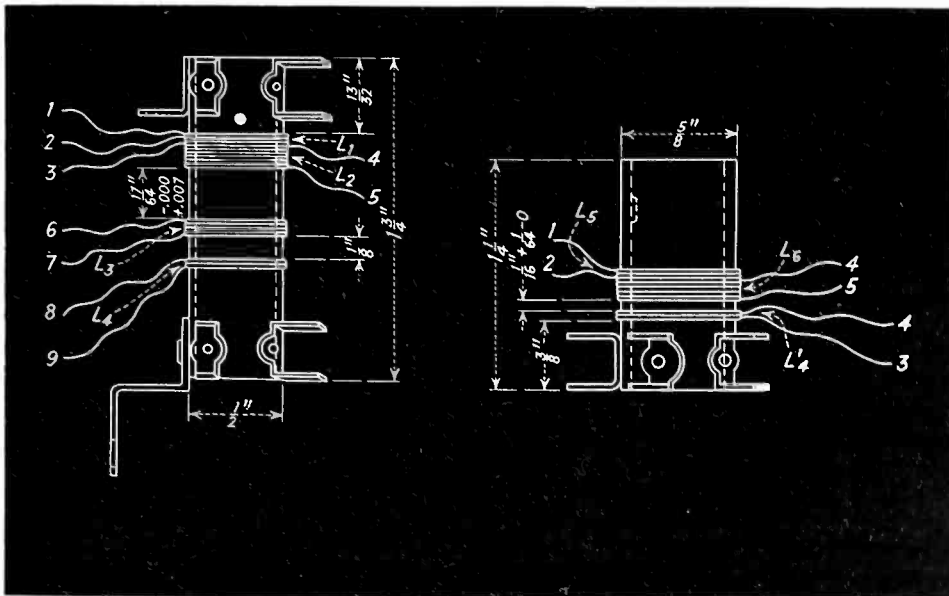

Fig. 6—Left, r-f coil dimensions. Right, oscillator coils. The numbers on the leads correspond with those on Fig. 1

age circuit uses the low-capacitance type of R-C filter which allows 7000-volt operation without straining the pocketbook for filter capacitors, and at the same time is considerably safer from the standpoint of electric shock.

Physical Arrangement of the Receiver

The front view of the receiver, with the mirror lid raised, is shown in Fig. 2. The mirror itself is $\frac{1}{8}$ -inch plate glass specially selected by the neighborhood glazer as having faces both plane and parallel, and coated with a high quality silver mirror surface on the back side. Reflection from the front surface on the mirror, while present, is not sufficient to cause a double image to be apparent when viewing the program. The cabinet itself is a standard product intended for a radio-phonograph combination, purchased from a radio supply house. The cathode ray tube is protected by a 10-by-12 inch plate of shatterproof glass. The

various controls (some of which are visible in the mirror in Fig. 2) are brought up through the top partition of the cabinet, surrounding the picture tube. To the left are the sync and scanning-circuit controls, to the right the signal-circuit controls, and at the front the high-voltage bleeder controls (brightness and focus). These controls issue from the corresponding chasses, as described below.

The rear view of the receiver, with the protective screen in place is shown in Fig. 3. This screen, made of copper netting, cannot be removed without opening interlock connections on both high and low-voltage power supplies. The screen allows ventilation of the 300 watts of power consumed and converted to heat by the set.

The view of the interior of the receiver with the screen removed (Fig. 4) shows that the circuits are laid out in three chassis. At the bottom is the power supply chassis,

including two low-voltage supplies and the high voltage supply. At the left is the signal chassis, with antenna terminals at the top and video signal lead at the bottom leading to the base of the picture tube. The picture tube with the high voltage bleeder resistors and controls is mounted on a bakelite platform on the power supply chassis. At the right (viewed from the rear) is the scanning chassis which takes the sync pulses from the signal chassis and generates the scanning current for the yoke which is supported around the neck of the picture tube by brass brackets. No loudspeaker is included in the cabinet, for two reasons, first that there was no room for a loudspeaker of sufficient size to make use of the high fidelity output, and secondly to avoid magnetic reaction of the field structure of the speaker on the cathode-ray scanning beam. The audio output transformer is included in the signal chassis, and two leads about 15 feet long are brought out from the rear of the cabinet for the voice coil of the speaker. In practice, a 15-inch loudspeaker in a all-wave broadcast receiver has been used. No acoustic feedback or other instability has been found.

The Power Supply Chassis

The division of the circuits in the three chassis is indicated by dotted lines on Fig. 1. At the right is the power supply section. The top and below-decks views of this chassis are shown in Fig. 5. The supply for the signal circuits is arranged in a line along the lefthand edge of the chassis. It includes a two-section filter. A similar supply arranged along the opposite edge supplies

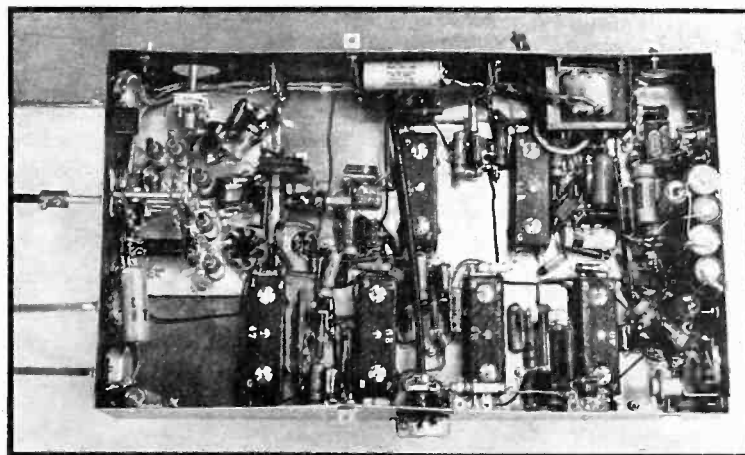
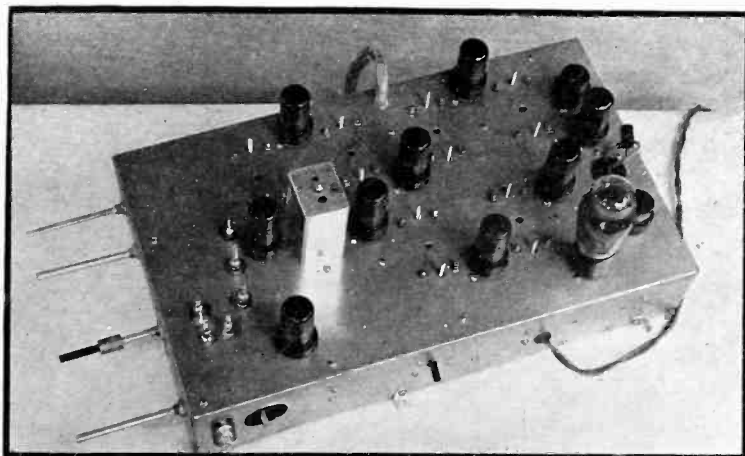

Fig. 7—Top and bottom views of the signal chassis, which includes all circuits from antenna to cathode-ray tube and loudspeaker

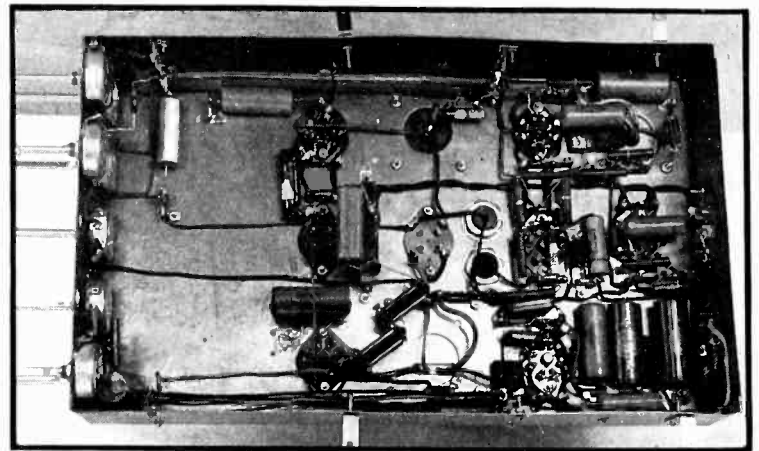
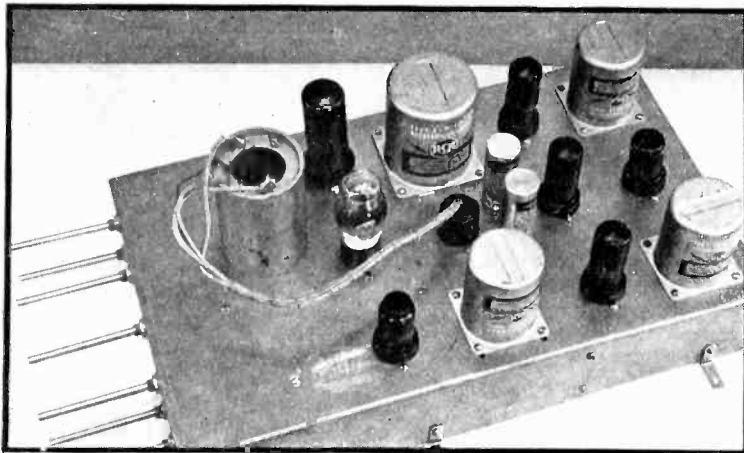

Fig. 8—Top and bottom views of the scanning generator chassis, which includes sync signal amplifiers and separator circuits. The scanning yoke appears at the left

power to the scanning chassis, through a single-section filter. Six-conductor cables with standard plug and socket connectors lead from the low voltage power supplies to the chasses immediately above them.

The high-voltage supply occupies the center of the chassis (Fig. 5). The high voltage transformer is an Acme neon-sign transformer, model 207, rated at 7500 volts, r-m-s. A resistor in series with the primary of this transformer limits the output voltage of the supply to 7000 volts d-c, and insures that the transformer is operating well under its maximum rating. This increases the life expectancy of the transformer.

The rectifier is a type 879 tube, which is operated above its maximum rating, but which appears to give good service. The type 2V3G, which made its appearance after the supply was built, is a better tube for the purpose. The filter capacitors are G.E. pyranol units, type 23F73, rated at 0.03 μ f, 7000 volts d-c. The resistor R_{101} between them consists of three 150,000 carbon units in series. The bleeder consists of R_{90} , 100,000 ohm brightness control; R_{97} , two 150,000-ohm carbon units; R_{98} , two 325,000-ohm units; R_{99} , a 500,000-ohm focus control; and R_{100} , ten 500,000-ohm units in series. The leads from bleeder to the picture tube are made across the bakelite platform directly to the socket. Extension rods from R_{90} and R_{99} , as shown in Fig. 4, lead directly upward to knobs above the cabinet partition. The interlock consists of two tubular fuse mounts connected in series with the power supply, mounted on the chassis, which engage clips on the protective wire screen. From these clips wires lead upward around the edge of the

frame to similar clips which are engaged by fuse mounts near the top of the cabinet. Wires from these mounts extend to the on-off switches. Removing the wire screen thus breaks the circuit directly in series with the on-off switch, in two places. Two complete interlock circuits are employed, one in series with the high voltage transformer primary, and the other in series with all the other transformer primaries. The arrangement allows independent control of the high and low voltage circuits, which is a distinct advantage in development work, but not necessary otherwise.

The Signal-Circuit Chassis

The signal circuit chassis, shown within dotted lines in the upper portion of Fig. 1, includes all circuits between the antenna and the cathode-ray tube control grid and between antenna and loudspeaker voice coil. The r-f circuits are based on the design of the Andrea Radio Corporation, and are essentially the same as those employed in the television kit manufactured by that company. Since these parts are not available separately, it is necessary for the constructor to wind the coils by hand. The coil data, shown in Fig. 6, is published by the permission of the Andrea Radio Corporation. The antenna coil consists of four windings (L_1 L_2 L_3 L_4) wound of No. 26 enamelled copper wire on a $\frac{1}{2}$ -inch outside diameter form. Coil L_1 is two turns, center-tapped, close wound. Coil L_2 is six turns of the same wire, and is close-wound directly alongside coil L_1 with no separation between the two coils. Coil L_3 is four turns of the same wire, close wound and separated exactly $\frac{17}{64}$ th inch from L_2 on the

same form. The pick-up coil L_4 is two turns of the same wire, space $\frac{1}{8}$ th inch from L_3 on the same form. The details are shown in Fig. 6.

The oscillator coil consists of three windings on a $\frac{3}{8}$ th-inch outside diameter form. The pick-up coil L'_4 is one and two-fifths turns of No. 22 enamelled copper wire close wound. The grid coil L_5 is two and one-fifth turns of No. 22 wire close wound and spaced exactly $\frac{1}{16}$ th inch from L'_4 . The plate coil L_6 is two and four-fifths turns of No. 22 wire on the same form and wound directly adjacent to L_5 . The two coil forms (antenna and oscillator) are mounted at least three inches apart, so that no couplings exists between them except through the coils L_4 - L'_4 .

The tuning capacitors employed are tubular adjustable units manufactured by RCA which can be adjusted and locked in position. Any good quality air-trimmer capacitors will suffice. Switching between bands is accomplished by a three-pole double-throw rotary switch. The three μ μ f capacitor units are small zero temperature coefficient units which aid in maintaining the circuit adjustment. The variable trimmer C_{12} in the oscillator circuit is brought out to a knob at the rear of the set, and seldom needs adjustment. However, it might be desirable to make this control available through the cabinet partition in the same manner as the other controls.

The picture i-f stages employ 6AC7/1852 tubes to obtain maximum gain, although 6AB7/1853 tubes are somewhat preferable when lower gain can be tolerated. The i-f coupling units are manufactured by the F. W. Sickles Company and were described in the May, 1939 issue of *Electronics*, pages 21 and 22. Units

T_1 , T_2 , T_3 and T_4 are permeability-tuned wide-band picture i-f units with trap circuits included while T_5 and T_7 are the sound i-f units, somewhat similar but displaying a band width of roughly 150 kc. Unit T_6 is a rejector-acceptor unit in the sound i-f input. The connections indicated correspond to the markings on the cases of the units, all of which except T_5 mount under the chassis.

The sound system is completely conventional except for the rather high value of i-f intermediate frequency, 8.25 Mc. It is aligned in the conventional way, by applying 400-cps-modulated 8.25 Mc carrier to the grid of the last sound i-f tube and tuning for maximum output at the sound second-detector load, then repeating for the next-to-last sound i-f stage. Full alignment instructions are supplied with the coupling units by the manufacturer.

The picture i-f alignment, which presents a considerably more difficult procedure, is likewise outlined by the manufacturer. The author was fortunate in having available the services of a first-class i-f sweep oscillator and oscilloscope, so that alignment could be performed visually. This is by all odds the simplest method, but it is quite possible to align the stages with a signal generator in point-by-point fashion if sufficient time and patience are

available. If point-by-point alignment is employed, each stage should be aligned as a separated unit, using an external detector to obtain the output readings. Then the three stages are combined and an overall check of response vs. frequency is performed. If the overall response is not satisfactory, slight adjustments to each of the stages may be made, but any attempt to compensate for the deficiencies of one stage by overcompensation in another stage is apt to introduce undesirable phase responses. Hence the need for making each stage behave properly as a unit before combining it with the others. The picture i-f system is capable of delivering a gain of about 3,000 to 4,000 over a bandwidth of 3.95 Mc. The gain control of the picture i-f system (contrast control of the receiver) is the manual control R_{13} which applies bias to the first two picture i-f amplifier tubes. The control operates very satisfactorily and introduces no difficulties from feedback.

The picture second detector (the left hand section of the 6H6) operates into a filter-coupling arrangement. The coils L_7 and L_8 are universal wound chokes, but any coils of the indicated inductance will suffice. The signal for the video amplifier is taken from the mid-shunt tap of the filter element. The capacitor C_{33}

serves no real purpose (since the d-c restorer tube follows later in the circuit) and hence may be omitted. If it is omitted, R_{33} may also be dispensed with.

The video amplifier is substantially the same as that used in the "laboratory" receiver previously described. The peaking coil L_{10} is a universal wound choke, but, as in the case of L_7 and L_8 , may have almost any form provided it has the indicated inductance. The d-c restorer rectifier (automatic brightness control) serves to develop a bias on the cathode ray tube grid which is equal to the peak level of the output video signal, and hence remains fixed regardless of changes in the waveform of the video signal. The average d-c component applied to the picture tube control grid then depends on the average of the picture signal, and the average brightness of the scene is correctly reproduced. In operation the screen of the picture tube is dark until the picture signal appears, whereupon the screen assumes a level of brightness proportional to the level actually being sent from the transmitter. Fade-outs in motion pictures and similar changes in brightness are thereby properly reproduced. The 6H6 automatic brightness tube performs the only function not performed in the laboratory receiver.

The sync separation function (performed by the right-hand section of the first 6H6 tube, in conjunction with the second detector) operates by virtue of the fact that the bias developed by this tube approximates the blanking level in the video signal, and hence the only current flowing through the diode elements is that due to the sync pulses. A filter consisting of L_9 (two pies of a 4-pie 2.5 millihenry r-f choke) and C_{60} serves to prevent the passage of any i-f components to the sync circuits. The wire leading from L_9 to the scanning chassis is a 2-foot length of shielded concentric cable with a standard plug-and-socket connector.

The photographs in Fig. 7 show the top and bottom views of the signal circuit chassis just described. The four controls which issue from the top of the chassis (as mounted in the cabinet) are the tone control R_{62} , the contrast control R_{13} , and volume control R_{61} , and the station-selector switch. As viewed in Fig.



Fig. 9—RCA-NBC test chart, reproduced by the receiver from a one millivolt signal under normal conditions. The actual size of the image was 8 by 6 inches



Fig. 10—Images photographed directly from the mirror of the receiver, during the telecast of "The Donovan Affair" from the NBC transmitter. Exposures 1/10th second, at $f/4.5$, Agfa Superpan Press, enlargement about four times

7, the top side of the chassis shows the sound channel toward the front of the picture and the picture channel toward the rear. The layout is not critical but should insure the shortest possible leads from picture i-f tubes to the coupling units, as well as short leads in the second detector and video sections of the receiver.

The alignment of the r-f portions of the receiver is as described in the articles on the laboratory receiver. For those readers who do not have the July to December 1938 issues of *Electronics*, the series of articles is available in reprint form in the booklet "Television Receiver Practice", issued by the *Electronics* editorial department at a price of 50 cents.

Scanning Chassis

The remaining chassis is the scanning chassis, shown at the bottom of Fig. 1 and illustrated photographically in Fig. 8. The reader is referred to the above-mentioned articles on the laboratory receiver for a description of the operation of the blocking oscillator and amplifier circuits, as well as of the methods of testing linearity and other aspects of sync performance. The only significant difference between the circuits of the laboratory receiver and the present design is the inclusion of the filter C_{68} , R_{70} , C_{69} , R_{73} , C_{70} in the input of the vertical blocking oscillator. This filter insures that none of

the high-frequency horizontal sync pulses will be present to exert control of the vertical scanning generator. The controls brought out to the cabinet partition are nine in number: vertical hold control R_{73} ; vertical size control R_{75} ; vertical peaking control R_{76} ; vertical distribution control R_{78} ; vertical centering control R_{81} ; horizontal hold control R_{86} ; horizontal size control R_{89} ; and horizontal centering control R_{95} . It has been found very desirable to have all these controls available, although they require only occasional adjustment. In all there are 16 controls including the on-off switch. Of these only seven require adjustment from day to day. These controls, which have been fitted with red knobs, are vertical hold, horizontal hold, brightness, focus, contrast, volume, and station selector.

Examples of received images are shown in Figs. 9 and 10. Figure 9 is the standard NBC test pattern. The picture was taken directly into the mirror of the receiver when it was operating at the fore-mentioned location (10 miles from the transmitter, signal level about 1 millivolt). This illustration does not do justice to the receiver in all respects, since the photographic processes and the photoengraving have obliterated some of the detail actually present in the received image. However, the image is otherwise representative of the normal performance. The vertical detail (indicated by the

horizontal "wedges" of converging lines) is about 350 lines, that is, the wedges are resolved to the center circles. In the horizontal direction the detail limit (indicated by the vertical wedges), lies between 300 and 350 lines. The principle defect of the pattern is the increase in contrast from top to bottom of the picture, which is probably occasioned by improper phase response at 60 cycles of the video amplifier. However, the defect is noticeable only on the test pattern, and not during regular programs. It should be noted that the tendency of the image to "tear" due to the picture signal influencing the synchronizing circuits, which was noticeable in the "laboratory" receiver, is completely absent in the present model.

Figure 10 shows two images photographed from the normal viewing position (i.e. camera aimed at the mirror) of scenes from "The Donovan Affair", a mystery drama recently telecast from the NBC studios. The detail is indicated by the pattern on the actor's tie (at the left), and by the sharp distinction between black and white at the edge of the tie.

The apparent detail of the scene at the right is less than that at the left, but this is due to the fact that the figures are smaller. The image is somewhat unusual in that it has a greater depth of perspective than most photographs of television pictures display.

Institute of Radio Engineers Fourteenth Annual Convention

September 20-23, 1939, Hotel Pennsylvania, New York, N. Y.

Program

WEDNESDAY, SEPT. 20

9:00 A. M.

Registration

10:00 A. M.—12:00 NOON

Opening address by R. A. Heising, President of the Institute.

"A Single-Sideband MUSA Receiving System for Commercial Operation on Transatlantic Radiotelephone Circuits," by F. A. Polkinghorn, Bell Telephone Laboratories, New York, N. Y.

"Medium-Power Marine Radiotelephone Equipment," by J. F. McDonald, Radiomarine Corporation of America, New York, N. Y.

2:00 P. M.—4:00 P. M.

"The Corner Reflector," by J. D. Kraus, Ann Arbor, Michigan.

"Gaseous Ionization and Surface-Corona-Discharge Detection at Low and High Frequencies," by H. A. Brown, University of Illinois, Urbana, Ill.

"A New Standard Volume Indicator and Reference Level," by H. A. Chinn, Columbia Broadcasting System, New York, N. Y.; D. K. Gannett, Bell Telephone Laboratories, New York, N. Y.; and R. M. Morris, National Broadcasting Company, New York, N. Y.

"Vestigial-Sideband Filters for Use With a Television Transmitter," by G. H. Brown, RCA Manufacturing Company, Camden, N. J.

A Cathode-Ray Frequency-Modulation Generator, by R. E. Shelby, National Broadcasting Company, New York, N. Y.

THURSDAY, SEPTEMBER 21

10:00 A. M.—12:00 NOON

"Solar Cycle and the F₂ Region of the Ionosphere," by W. M. Goodall, Bell Telephone Laboratories, New York, N. Y.

"Attenuation of High Frequencies Over Land at Short Ranges," by John Hessel, Signal Corps Laboratories, Fort Monmouth, N. J.

"Demonstration of Aerological Radio Sounding Equipment," by Harry Diamond, F. W. Dunmore, W. S. Hinman, Jr., and E. S. Lapham, National Bureau of Standards, Washington, D. C.

12:30 P. M.—2:00 P. M.

Informal Luncheon: Presentation of the Institute Medal of Honor to Sir George Lee of the British Post Office and the Morris Liebmann Memorial Prize to H. T. Friis of Bell Telephone Laboratories.

2:30 P. M.—5:00 P. M.

"A Parallel-T Circuit for Measuring Impedance at Radio Frequencies," by D. B. Sinclair, General Radio Company, Cambridge, Mass.

"High-Speed Multiplex System for Loaded Submarine Cables," by H. H. Haglund and A. W. Breyfogel, Western Union Telegraph Company, New York, N. Y.

"Electronic-Wave Theory of Velocity-Modulation Tubes," by Simon Ramo, General Electric Company, Schenectady, N. Y.

"On Refraction and Radiation of Electromagnetic Waves," by S. A. Schelkunoff, Bell Telephone Laboratories, New York, N. Y.

FRIDAY, SEPTEMBER 22

10:00 A. M.—12:00 NOON

"Cathode Ray Tubes in Aircraft Instrumentation," by C. W. Carnahan, Hygrade Sylvania Corporation, Emporium, Penna.

"A True Omnidirectional Radio Beacon," by E. N. Dingley, Jr., United States Navy Department, Washington, D. C.

"Basic Economic Trends in the Radio Industry," by Julius Weinberger, Radio Corporation of America, New York, N. Y.

"Engineering Administration in a Small Manufacturing Company," by C. T. Burke, General Radio Company, Cambridge, Mass.

2:00 P. M.—4:00 P. M.

"Aircraft Radio Compasses—Principles and Testing," by R. J. Framme, Aircraft Radio Laboratory, Wright Field, Ohio.

"Errors in Closed-Loop Direction Finders Caused by Abnormal Polarization," by R. I. Cole, Signal Corps Laboratories, Fort Monmouth, N. J.

SATURDAY, SEPTEMBER 23

10:00 A. M.—12:30 Noon

"Functions of Electron Bombardment in Television," by I. G. Maloff, RCA Manufacturing Company, Camden, N. J.

"Transient Response in Television," by H. E. Kallmann, formerly of Electrical & Musical Industries, Ltd., in collaboration with R. E. Spencer and S. P. Singer, Electrical and Musical Industries, Ltd.; Hayes, Middlesex, England.

"A Wide-Band Inductive-Output Amplifier," by A. V. Haeff, and L. S. Nergaard, RCA Manufacturing Company, Harrison, N. J.

2:00 P. M.—4:30 P. M.

"Superheterodyne First-Detector Considerations in Television Receivers," by E. W. Herold, RCA Manufacturing Company, Harrison, N. J.

"Development of a 20-Kilowatt Ultra-High-Frequency Tetrode for Television Service." (In three parts.)

Part I. "Electrical Design," by A. V. Haeff, L. S. Nergaard, RCA Manufacturing Company, Harrison, N. J., and W. G. Wagoner and P. D. Zottu, formerly of RCA Manufacturing Company, Harrison, N. J.

Part II. "Construction," by R. B. Ayer, RCA Manufacturing Company, Harrison, N. J., and P. D. Zottu, formerly of RCA Manufacturing Company, Harrison, N. J.

Part III. "Test Equipment and Results," by R. B. Ayer and H. E. Gihring, RCA Manufacturing Company, Harrison, and Camden, N. J., respectively.

"Production Alignment Apparatus for Television Receivers," by L. J. Hartley, General Electric Company, Bridgeport, Conn.

(1) Resigned, now with Heintz and Kaufman, Ltd., South San Francisco, Calif.

(2) Resigned, now with Thermal Engineering Corporation, Atlanta, Ga.

THE TIME TELESCOPE

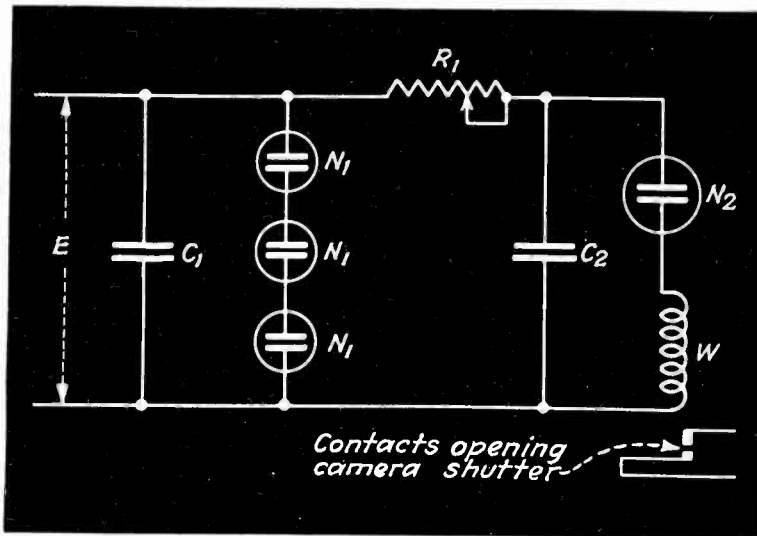

Fig. 1—Condenser C_1 , which is charged to a voltage determined by the neon tubes, N_1 , acts as a power reservoir for the time lapse circuit

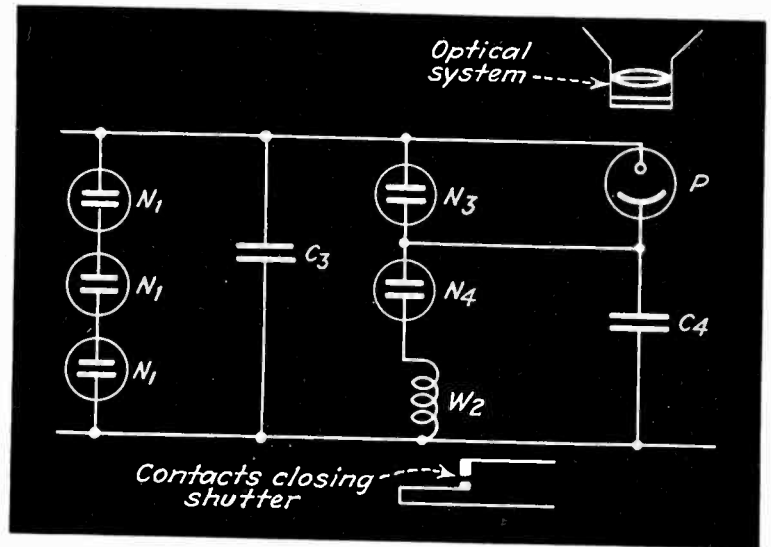

Fig. 2—The time of exposure is determined by the conductivity of the phototube, P , which is determined by the intensity of light falling on it

THE contributions of photography to the development of the electronics industry are not very extensive, although they are highly important. Perhaps the most familiar example of this use of photography is represented by the oscillographic records made with a string or cathode-ray oscilloscope. Photographs of natural as well as man-made lightning, of the paths of elementary charged particles in atomic physics, and radiographs of tube structures have all aided in the development of the electronics industry.

But one branch of research and knowledge climbs upon the back of, and benefits from another branch. Just as electronics has benefited from the use of photography, so has photography made extensive use of the products and knowledge in the electronics field. For example, as a result of many improvements in the design and manufacture of incandescent lamps, photographers have available photoflash and photoflood lamps, as well as bulbs for general lighting. Electronic equipment is used in the manufacture of photographic materials. The high speed photographic technique developed by Edgerton and his associates at the Massachusetts Institute of Technology, depends entirely upon the application of equipment and prin-

ciples developed by electronics engineers. This high speed photographic technique makes possible the production of motion pictures which greatly reduce the apparent speed at which the photographed subject moves.

At the other end of the time spectrum, if we may use that term, is the time lapse photographic technique which greatly increases the apparent speed with which a subject moves. Ordinary slow motion photographs are familiar to every motion picture enthusiast, but the apparent speed change can be carried to great lengths. Thus, motion which is totally imperceptible to the eye may be made to appear like the dance of a whirling dervish, under the appropriate conditions.

Fundamentals of Time Lapse Photography

The basis of slow motion photography lies in the relative rates of speed with which the original subject is photographed and projected onto a screen. If the original subject is photographed at a very slow rate (i.e., with a lapse of time between successive exposures which is large compared to the duration of the exposure time of the individual motion picture frames) and the film projected at the normal speed, any motion which has taken place during

the successive exposures is apparently speeded up. To illustrate this point let n be the number of frames per unit time which are photographed of the original subject, and let p be the number of frames projected during the same unit of time. Then, the apparent speed ratio, S , will be

$$S = p/n$$

so that by varying either n or p (or both) the apparent speed change can be made any desired amount within reason. Ordinarily the speed of projection is 24 frames per second, so that if the second is used as the unit time, $p = 24$. If now the second is used as the time unit and the original subject is photographed with a time lapse of one hour between successive exposures, $n = \frac{1}{3600}$, $p = 24$, and consequently the speed ratio is $S = 86,400$. With a speed ratio as great as this, a full year's growth of a plant may be seen on the screen in 6.1 minutes. The human eye and brain may not discern slight day-to-day changes in a growing plant, but they cannot fail to observe the important alterations taking place when viewing a film having such alterations in time.

Extreme care must be taken in the preparation of time lapse films because the element of time involved in making the original motion pic-

Electron tube equipment, used to control automatically and completely a motion picture camera in time lapse photography, aids in research studies at Rutgers University

By BEVERLY DUDLEY
Associate Editor

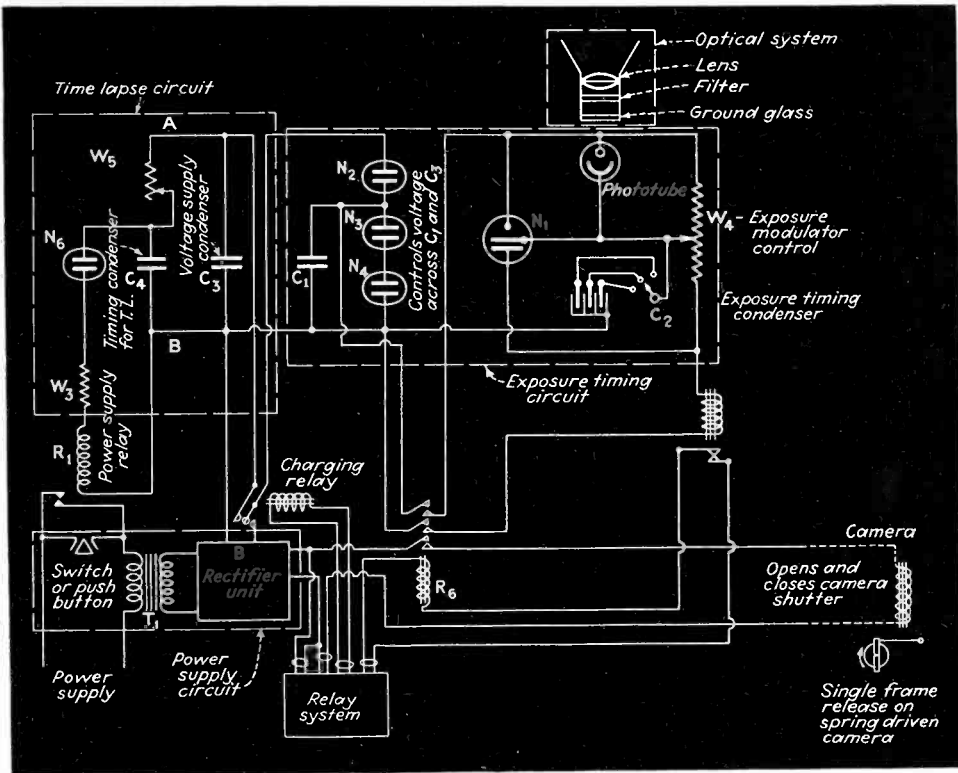

Fig. 3—A simplified schematic diagram of the time telescope unit. Correlation of the circuits determining exposure time and interval between exposure is effected by a system of timed relays

ture film is very important. A complete record of a growing plant, of the construction of a bridge or building, or of any other slowly moving process may take months or even years to complete. In many cases there is only one opportunity to make a suitable record, and that record must be absolutely correct from beginning to end, without errors, interruptions, breakdowns, or other undesirable conditions taking place. Moreover, the photographic process must take into account the vicissitudes of time, weather, and other factors likely to affect the photographic process during the making of the entire film.

Equipment which meets all reasonable requirements for time lapse photography has been developed, over a period of years, at Rutgers University, primarily for the study of plant growth. Several complete control units for actuating the

camera and the illumination have been built. The latest of these, called the "Time Telescope" by Clinton P. Veber who developed the device, is almost uncanny in the operations it will perform. It has been in use for a sufficiently long period of time to be thoroughly tested under all conditions of operation. Most important of all, from the standpoint of readers of *Electronics*, is the fact that the control equipment is entirely electronic in operation and has no moving parts other than the control knobs and the relay contacts.

The time telescope is a compact, rugged, foolproof—and especially for the multitude of operations it performs—comparatively inexpensive unit for controlling the operation of a motion picture camera used in conjunction with it. It is fully automatic in operation, will operate under any reasonable con-

ditions of temperature or humidity, is completely electro-optical in operation and will make exposures anywhere, at any time, under light of varying or constant intensity or spectral distribution. So long as there is film in the camera and power is supplied to the time telescope, time lapse exposures will be made under the conditions for which the unit is adjusted. Through the use of control circuits in which a phototube and RC discharge elements play an important role, the exposure time is automatically determined and the lapse between successive exposures can be predetermined. When the time approaches for the making of an exposure, a warning signal is given about ten seconds before the exposure is made. This signal permits the attendant to remove himself from the scene so as not to appear in the photograph. The exposure is automatically timed by the aid of a phototube so that each frame receives the same amount of light and therefore has the same average density. Or, if desired, an exposure modulator can be used which will increase or decrease the normal exposure for such special effects as simulating the approach of dusk or of dawn.

At the beginning of the exposure period, incandescent lamps are turned on so that adequate illumination is always available. If desired, these lights may be made to turn on about three seconds after the shutter is opened, so that the lamps do not become operative during daylight, since daylight exposures are usually of less than three seconds exposure.

An interesting feature of the equipment is that the time telescope consumes current only during the exposure time. During exposure, a

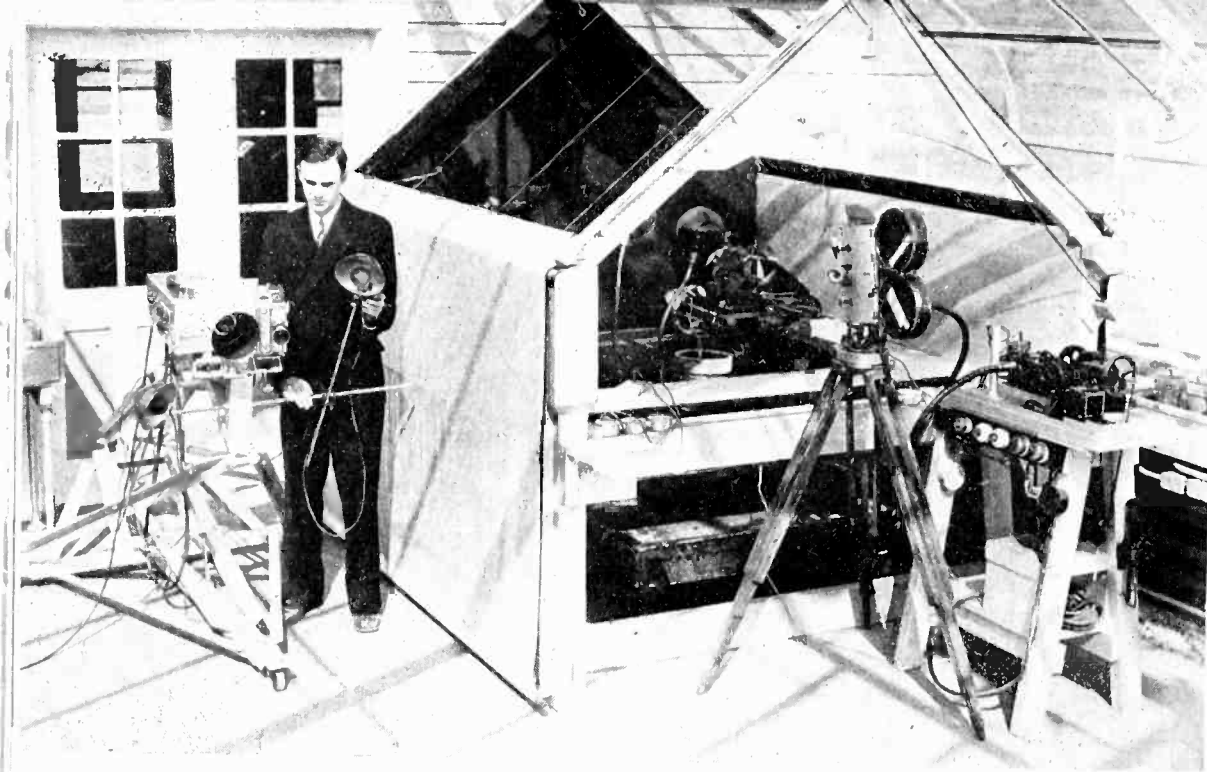

Fig. 4—A comparison of the old and the new. At the right is the original equipment with its special chamber for the subject and its several units. C. P. Veber is shown with the latest equipment at the left which is contained in one unit

large condenser is charged, and after being completely charged, it gradually discharges through a resistance to determine the time lapse period. It might be said that the device takes a bite of electricity during exposure time and is then satisfied with its meal until the next exposure is made. The condenser acts as a power supply, but is charged only intermittently, and gradually dissipates its charge in a way which controls the time lapse period. A similar circuit, operating by virtue of a RC series circuit is likewise charged and discharged in such a manner as to determine the time of duration of the exposure.

In its present form, the time telescope may be operated from a 6 volt storage battery or from the 110 volt a-c line at will. It may be set to have a time lapse period of from $\frac{1}{2}$ second up to 1 hour, and the time lapse period is independent of humidity and depends slightly (about 1 or 2 per cent) on wide changes in temperature. The time lapse period is independent of the exposure time, except for those cases in which the latter exceeds the former, as may occasionally be the case in special instances. Time lapse periods longer than 1 hour may be made manually without turning off the machine or in any other way interfering with its operation. The device is capable of making constant exposures which are continuously variable from $\frac{1}{10}$ second to 10 min-

utes when the ambient light is constant. However, when the light is variable, variable exposures may be made so that each frame receives the desired exposure and has the same average density.

For description of this time telescope, the reader is referred to U. S. Pat. 2,156,440, "Combination Time Lapse and Photoelectric Exposure Control Mechanism" issued to Clinton P. Veber on May 2, 1939.

Principle of Operation

In its most elementary form, the principle of operation of the time telescope depends upon the charging and discharging of an electric circuit containing a condenser and resistor. This circuit, in turn, acts to ionize a gaseous discharge lamp, such as a neon bulb, which actuates the desired control elements. The charging and discharging rates of these circuits determine the operating times for the control of the photographic equipment. While the complete diagram is highly complicated, it may be broken down into simple elements for purposes of explaining the underlying mode of operation. Essentially, the fundamental circuit consists of two parts: (1) the time lapse circuit which controls the interval between exposures, and (2) the exposure circuit, which controls the duration of the exposure as a function of the intensity and quality of the light.

The time lapse circuit is shown in

its most elementary form in Fig. 1. A voltage, E , charges the condenser C_1 to a voltage which is determined by the neon voltage regulating tubes, N_1 . The circuit is so arranged that the source of voltage is removed as soon as C_1 becomes fully charged. The condenser, C_1 , now acts as a power reservoir for the rest of the circuit, and discharges through the resistor R_1 and the condenser C_2 , building up a voltage across the latter. The rate at which the voltage across C_2 builds up depends upon the resistance, R_1 , and the capacitance of the condenser, C_2 . When the voltage across C_2 reaches a critical value, the neon tube, N_2 ionizes, and in the conducting state, permits a pulse of current to flow through the relay winding, W , recharging C_1 , thus starting a new time lapse cycle, and actuating the contacts which open the shutter of the camera, thereby initiating exposure.

Just before the shutter is opened, another relay (not shown) charges the condenser, C_3 (at the same time C_1 is charged) in the exposure time circuit of Fig. 2. The charge on C_3 discharges through the phototube, P , into the timing condenser C_4 , and when the voltage across N_1 reaches the critical value of breakdown, this neon tube becomes suddenly conducting, triggers off N_2 and permits a pulse of current from C_3 to flow through the relay winding W_2 , actuating the contacts which close the shutter of the camera. During and after the exposure period, condenser C_2 of the time lapse circuit is being charged, and as soon as it reaches the breakdown potential of N_2 the cycle is repeated. The exposure time depends upon the resistance of the phototube, P , and this, in turn, depends upon the light falling upon it. Consequently, the light falling upon the subject, which is focussed on the phototube, P , by means of the optical system of the time telescope, thus controls the exposure time.

The two elementary circuits described are, of course, combined in such a way that they operate as a unit, repeating the cycle just outlined as often as required. A more complete diagram (intended to illustrate these principles of operation rather than to give design data) is shown in Fig. 3.

The simplified schematic wiring diagram is intended only for pur-

poses of illustrating the mode of operation of the time telescope control equipment, and is not intended to be a complete explanation of the numerous and various controls which may be effected by this equipment. Further details are contained in U. S. Pat. 2,156,440 which should be consulted for more complete explanation.

To illustrate the fundamental mode of operation, assume that the circuit is being used for the first time and that, consequently, all voltages in the circuit, including those across condensers, are zero. Now, if the power is applied to the circuit

by pressing the push button, a momentary flow of current will flow through the transformer and rectifier, and will appear at the output of the rectifier as the appropriate and desired dc. Two input sources are shown, one of which feeds the relays while the other is the high voltage which charges condensers C_1 and C_3 , when the charging relay contacts are closed. Contacts of R_6 close after C_1 and C_3 have been charged.

When the voltage supply condensers C_3 and C_1 are charged by pressing the push button, the condenser voltages assume the extinguishing

voltage of N_2 , N_3 , N_4 , which thus act as voltage regulating devices. As time passes, the condenser C_3 discharges through W_5 , W_6 , and C_4 , building up a voltage across C_4 . When the voltage across C_4 reaches the critical or breakdown voltage of the neon tube N_6 , the tube becomes conductive, passes a pulse of current, closes the relay contacts, and applies another pulse of current to the transformer and rectifier, thus repeating the cycle already followed through. The rate at which this cycle occurs depends upon the values of C_3 , C_4 , W_5 , and W_6 , but W_5 and W_6 are used to control the time lapse cycle or time lapse period.

While C_3 is discharging to build up a voltage across C_4 , and as soon as R_6 is actuated, the voltage of C_1 is applied across N_1 , and, of course, the phototube and the condenser C_2 . Thus, C_1 acts as the power supply for the phototube circuit. Here again the voltage across N_1 charges the condenser C_2 , and builds up a voltage across it at a rate depending upon the capacitance of C_2 and the conductance of the phototube and of W_4 . When the voltage across C_2 reaches the breakdown value of the trigger elements of tube N_2 , it becomes conducting and passes a pulse of current through the relay which closes the camera shutter. Since the shutter was opened when relay R_6 was actuated, by means of a relay system not shown, and is closed when the relay in series with N_1 is actuated, the shutter is opened for the duration of the time taken to charge C_2 to the breakdown voltage of N_1 . The time required for this depends upon the conductance of the phototube, and this, in turn, depends upon the light falling upon it from the photographic optical system.

This elementary illustrative circuit is divided into three parts: (1) the power supply circuit, (2) the time lapse circuit TL , and (3) the exposure time circuit ET . The constants of the time lapse circuit are chosen so that, usually, the TL circuit operates much more slowly than the ET circuit, and the ET circuit is only brought into action at some predetermined set of conditions of the TL circuit. The entire circuit is operated through the discharge or charge of RC circuits and only consumes power when the push button is closed or when relay R_1 is actuated.

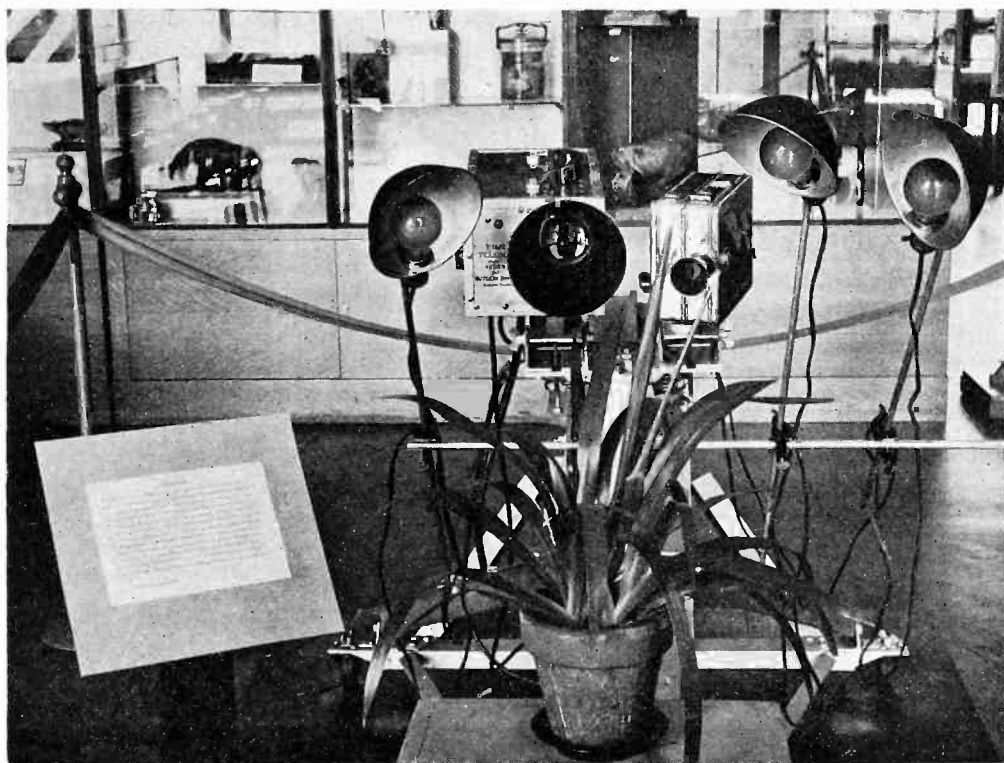
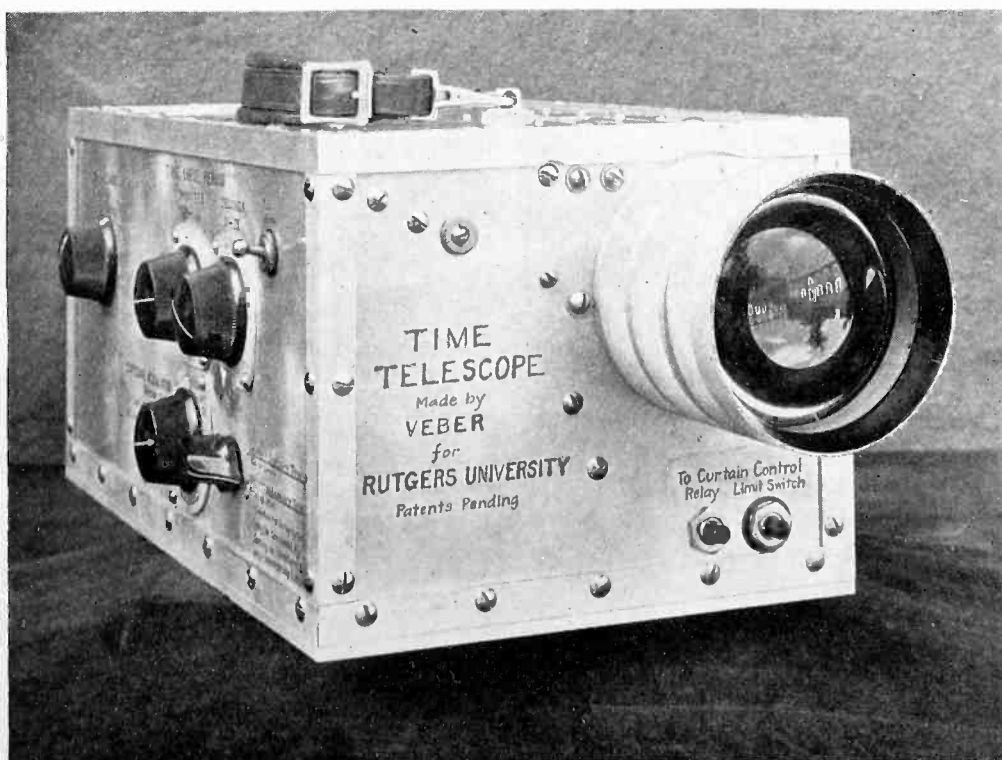

Fig. 5—Typical setup of the equipment with the subject in the foreground. The lamps are turned on automatically just before each exposure

Fig. 6—Complete electronic unit for controlling the lamps and motion picture camera for time lapse photography. The control knobs are at the left, while the phototube is behind the large lens



RESISTORS AND CONDENSERS IN MASS PRODUCTION

Resistors and condensers are essential to all electronic circuits. Automatic machinery plays a large part in their manufacture, which is described herein

By HERBERT CHASE

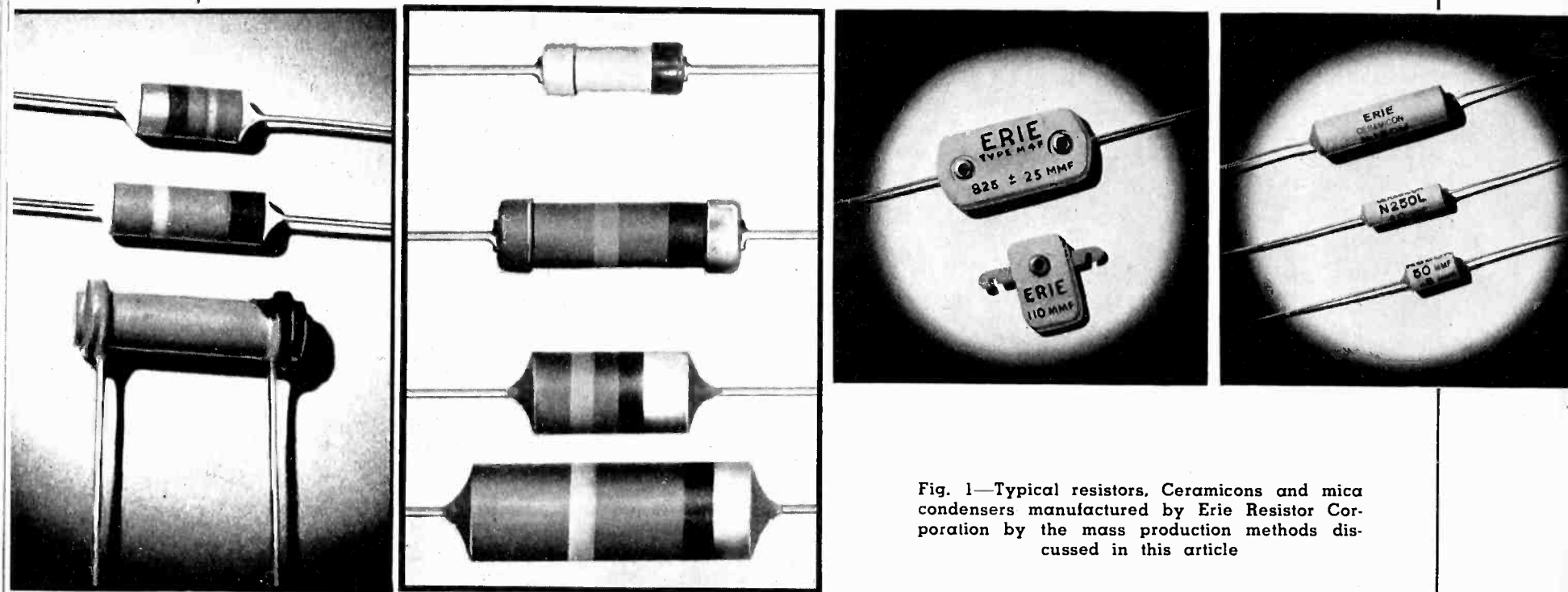

Fig. 1—Typical resistors, Ceramicons and mica condensers manufactured by Erie Resistor Corporation by the mass production methods discussed in this article

IN a strict sense, quantity production may never be reduced to an exact science but, from a commercial standpoint, a close approach to it has been attained in the plant of the Erie Resistor Corporation. There, both resistors and condensers are turned out in mass-production quantities, much of the work being done on ingenious automatic machines designed for the purpose. Some of these machines perform testing operations much more rapidly than tests can be made by hand, and at the same time eliminate human errors.

Two general forms of resistors are produced in a variety of sizes and resistance values, but all having as the essential unit a cylindrical bar of carbon. In one form, designed for use without a ceramic case, wire leads are soldered to a coating of copper applied to the carbon in the

form of a metal spray. In the other form, leads are first attached to brass caps which are subsequently pressed over the copper-coated ends of the bar after the resistance unit is assembled in a ceramic case.

Manufacture of resistors starts with preparation of a mix consisting of finely powdered carbon, a binder and inert materials. The mix issues from a mixing machine in hard lumps which are first dried, then ground in a mill and then screened. Ingredients of the mix are varied to yield the required resistance within a given dimension of bar. Initial forming of the carbon bar from the powdered material is carried out in a Stokes tableting machine. The formed bars are discharged onto a metal belt which carries them through a baking oven, from which they issue in hardened form.

The carbon bars which are to be

capped must be accurately sized in diameter to insure a tight fitting cap and these bars are passed through a centerless grinder which gives the required uniform diameter. All carbon bars, whether ground or not, are delivered to machines which apply the coating of copper to each end. The bars are loaded into a hopper in this machine, shown in an accompanying illustration, and from the hopper are advanced in successive steps along each of two tracks or guides. Above the tracks is mounted the metal spray gun into which copper wire feeds automatically. The gun is oscillated on a pivot so that the spray is directed first at one track and then at the other and back again, repeating the cycle continuously while the machine is running.

At the ends of the tracks, the carbon bars are given a rotary mo-

tion about their own axes while the spray is being applied, so that the coating is uniform over the area covered. Above the tracks are rotating disks which shield the portion of the rod not to be coated and confine the spray to a band of the required width. As soon as one end is coated, the gun shifts and coats the end of a bar on the other track. During this period, the first bar is advanced so that the other end may be coated. In other words, the spray is cut off while the bars are moved longitudinally and are being set in position for rotation. After the second end is coated, the bar is dropped out and is ready for delivery to the testing machine. Progress of the bars through the copper coating machine is in continuous step, the machine operating automatically and with very little attention.

Before the carbons coated on the ends with copper are assembled with other parts, it is necessary that their resistance be determined accurately and that they be sorted according to resistance value within the predetermined tolerances. This is accomplished in an automatic machine here illustrated. Carbons are fed onto a jig, carried by a slowly rotating wheel from a hopper, each carbon being fastened by a latch device which has two contacts in a constant voltage circuit. Below the jig, which rotates in a vertical plane, are eight bins, each of which receives those carbons which come within the resistance range intended for it. Unlatching and dropping of the carbon is effected by relays operated through an electronic control. This control consists of a tube in the grid circuit of which the resistor is connected. When the correct value of resistance, corresponding to a particular bin, is registered, the grid bias of the tube is sufficient to cause the plate current to actuate the relay. By this automatic machine, sorting can be done within 0.5 per cent of the nominal resistance value. When sorted, carbons dropped in each bin are kept separate, of course, until marked after assembly with a suitable color code. Carbons which do not fall within the range of values desired or are otherwise defective are automatically dropped into a reject bin.

The carbons which are to have soldered lead wires are transferred to another machine and are fed into

chucks arranged to progress along a chain from station to station. In this machine, the lead wire is automatically wound on each end of each carbon. The wire is applied over the copper coating and then cut to length. As the carbons with leads in place progress through this machine, the ends carrying the leads are dipped first in flux and then in molten solder and are subsequently discharged after the solder has hardened and made the required permanent electrical contact between the lead and the copper coated ends of the bars.

Following these operations, the resistors are transferred to a painting machine which is semi-automatic and is designed to apply lacquer to give the resistors the color on body, tip and dot required by the marking code. To apply these colors, the resistors are mounted in suitable carriers in the machine in such a way as to be brought successively into contact with the respective colors. The body and tip colors are applied by dipping as the resistors progress through the machine. As drying is required following the application

of each color, the parts are passed through ovens forming parts of the machine. The dot color is applied by a rotating disk which dips into a trough of lacquer and the edge of which is brought momentarily into contact with each of the resistors on the respective carriers. As much of this machine is inclosed, the operations are not readily photographed, but views of two stations in the machine are shown in accompanying illustrations. Manufacturing operations on this form of resistor are completed in this machine and the resistors issue from it ready for final checking of resistance value, packing and shipment.

Ceramic cases for resistors are received from outside sources, machined to the correct dimensions but without exterior marking. Before these cases are placed over the carbons, they are usually given an exterior body color and stripes to identify the resistance value. The color is applied on special machines which rotate the case while it is being sprayed at the required number of stations around a dial, using a quick-drying lacquer.

Resistors which are to receive the insulating cases require the application of brass caps to which the lead wires are riveted. The caps are small, cup-shaped stampings with a hole in the center to fit over the lead wire. Preparation of the cap and wire assembly is done in a special machine here illustrated. This includes a rotating dial which carries the wire from station to station. To make a secure joint between the wire and the cap, the wire is first upset to form, a short distance from one end, a shoulder against which the cap may rest. Upsetting is done

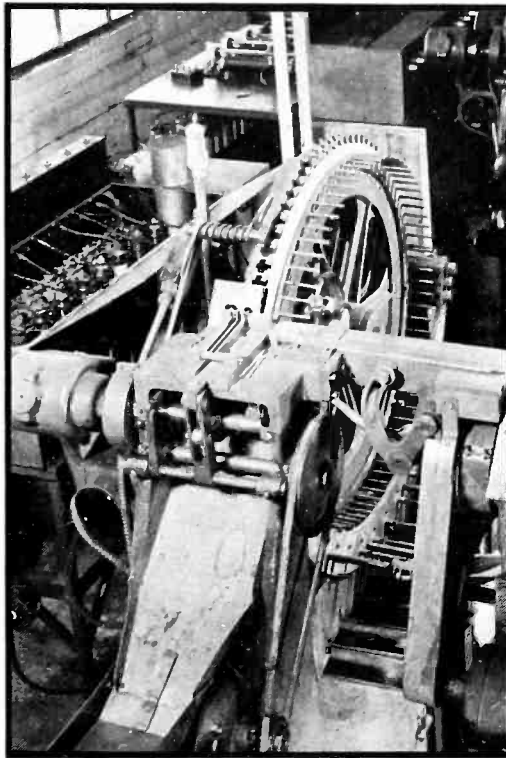
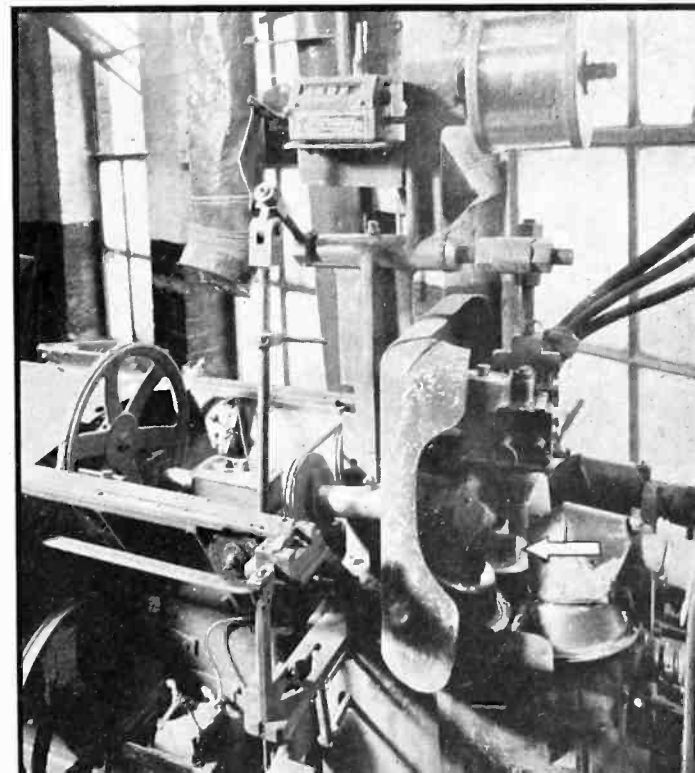

Fig. 2—Automatic tester and sorter for carbon rods. An electronic unit measures the resistance and drops them into the proper bins

Fig. 3—Machine in which carbon rods are sprayed at each end with copper. Note copper spray (arrow)



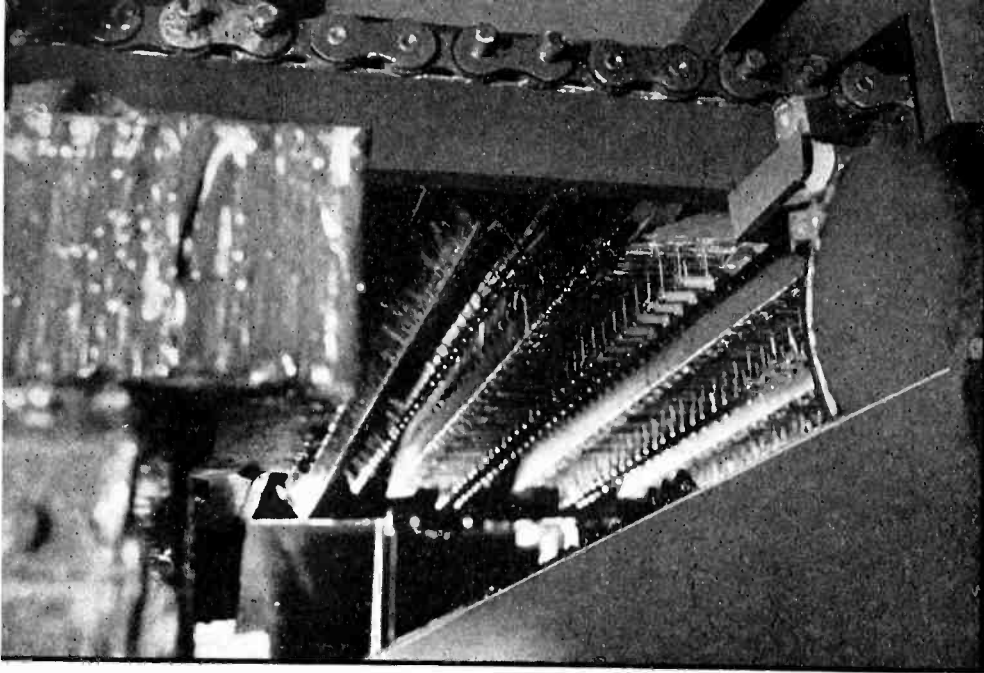

Fig. 4—A station on the painting machine which applies the three or four code colors to resistors after the leads are soldered to the copper sprayed ends

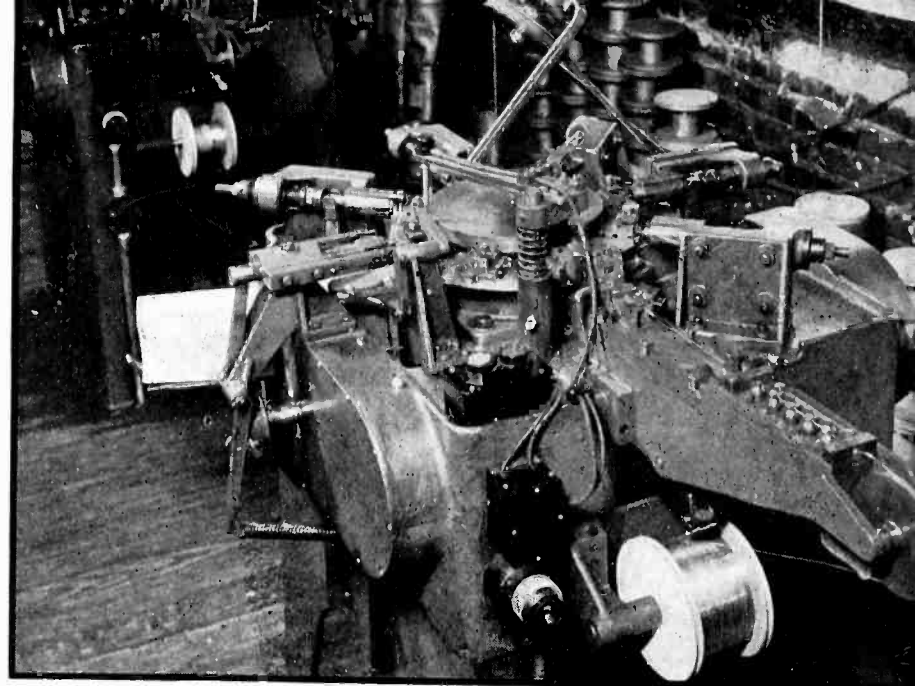

Fig. 6—On this machine, the lead wire is attached to the cap. A flange is upset on the wire, the cap is set on the wire and the end of the wire riveted

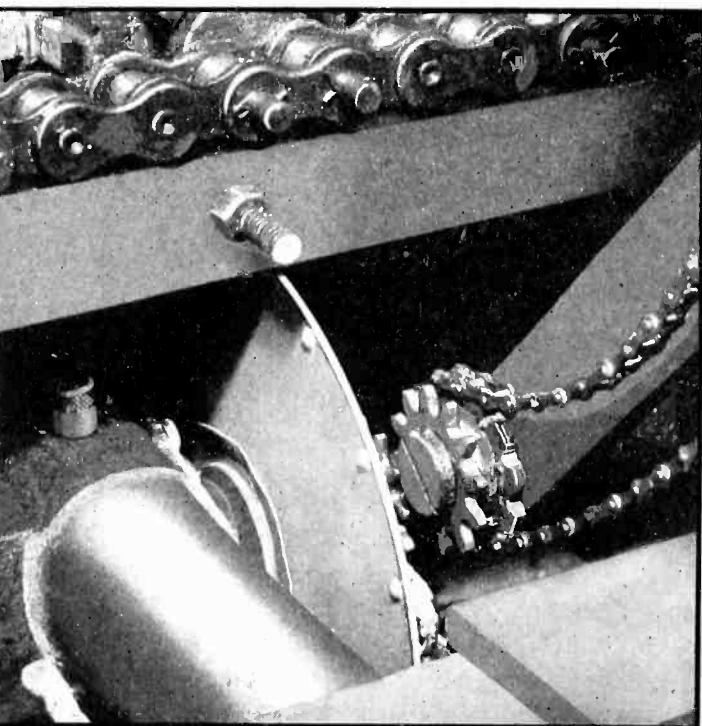

Fig. 5—Another station on the painting machine. The paint covered disc leaves a dot of paint on each resistor

by striking the wire in suitable dies arranged around the central dial. Wire, ready tinned, is drawn from a reel through a straightener and into the first die where it is cut to length. Successive operations then form the shoulder. Caps, fed in from a hopper at one station, are automatically slipped over the short end of the wire, with the outside of the cap against the upset flange, after which the short end of the wire is struck a blow which rivets or heads it over, permanently fastening the cap between the rivet head and the flange, after which the assembly drops from the machine. This machine operates automatically with

very little attention and at a rapid rate. It is arranged to stop automatically if wire jams at any station, or if the completed assembly is not ejected.

The caps with wires attached are then ready for assembly to the ends of carbon previously ground and copper coated, an operation which is done in a fixture illustrated in an accompanying figure. An operator at one side of a bench first slips the carbons into the ceramic shells and places these in a chute which carries them, one at a time, into a fixture before an operator on the other side of the bench. Each such fixture has a pair of sliding heads and into each of these the operator loads a cap with wire attached, caps inward. She then presses a treadle which brings the heads together and forces the caps one over each end of the carbon on which they are a press fit. This operation also locks the carbon into the shell or case and completes the resistor except for sealing and vacuum impregnating.

Sealing of the carbon within the ceramic shell is done in a special machine illustrated. The resistors are fed by hand into clips on a chain which carries them first to a gun which applies a fixed amount of cement to one end and then into an oven which sets the cement. Continuing through the machine, the resistors are similarly sealed on the other end, pass again through an oven and thence to the unloading station where they are removed from the clips. After a final baking to complete the cure of the cement, the units are vacuum impregnated in

wax, excess wax being removed in a "degreasing" operation. This completes the resistor and it is ready for inspection, packing and shipment.

Production of Fixed Condensers

Although the production of small fixed condensers involves certain procedures which are similar or identical, the different character of the product necessitates, of course, many different operations.

The fixed condensers are of two types: one with silver plates in intimate contact with a ceramic dielectric and marketed under the trade name, "Ceramicon", and the other with silver plates in intimate contact with a mica dielectric, called "silver-mica" condensers. Ceramicons have a definite, linear and reproducible temperature co-efficient and are widely used in tuned oscillator circuits to compensate for changes in frequency resulting from variations in temperature. They are made in numerous types: one with a positive temperature coefficient of 0.00012 per deg. C.; another, which has a titanium dioxide dielectric, with a negative temperature coefficient of 0.00068 per deg. C.; and others having coefficients between these limiting values. Since titanium dioxide has a high dielectric constant (85), fairly large capacities are obtainable in a rather small unit.

Manufacture of the Ceramicon begins with application of silver to the small tubes. This is done by placing the tubes on racks dipping them in the silver solution and sub-

sequently firing the tubes at high temperature to leave a coating of pure silver. Tubes are produced in the same standard diameters as for carbons used in making resistors and hence can take wired caps of the same size, made and applied in the same way with similar ceramic cases and sealed in the same manner on the same sealing machine used for resistors. In consequence, the finished product of this type looks the same as a resistor of the same physical type, except that the case, instead of being lacquered to identify it by a color code, is left without finish and is labeled by a special printing machine with code numbers and letters and at the same time is marked as to capacity and tolerance.

In the silver-mica type of condenser which has a temperature coefficient of $+ 0.00025$ per deg. C the mica sheets are stamped to size with holes for assembly, are given a treatment, to apply the silver, and then are assembled into a ceramic case made to fit them closely. Wire terminals with an eye formed at one end, and the other parts of the condenser (mica sheets and case) are fastened together with eyelets applied in an ordinary eyeletting machine. The eyelets not only hold the assembly together but establish the required permanent electrical contacts between the silver coatings of the mica and the terminals. The assembly, except for applying the eyelets, is done by hand and is quite simple.

In some forms of condensers, a resistor is assembled in the same case with the condenser to produce heat and compensate for temperature changes in some other part of the apparatus in which the unit is to be installed.

Testing or calibrating of condensers is accomplished with the type of apparatus shown in one of the illustrations, the unit being placed in a clip mounted at the left side of the instrument panel. Tests are made for both capacity and power factor at radio frequencies. The operator views a dial with limit markings set for particular specifications. Sorting is accomplished as a result of this test and the units tested are subsequently labeled for identification by the printing machine above mentioned, and are then ready for packing and shipment.



Fig. 7—Fixture used for applying capped wires to the ends of carbons, the latter first having been slipped inside a ceramic case and fed down the chute at the center. Jaws at each side of the chute, brought together by a treadle, force the cups over the ends of the carbon

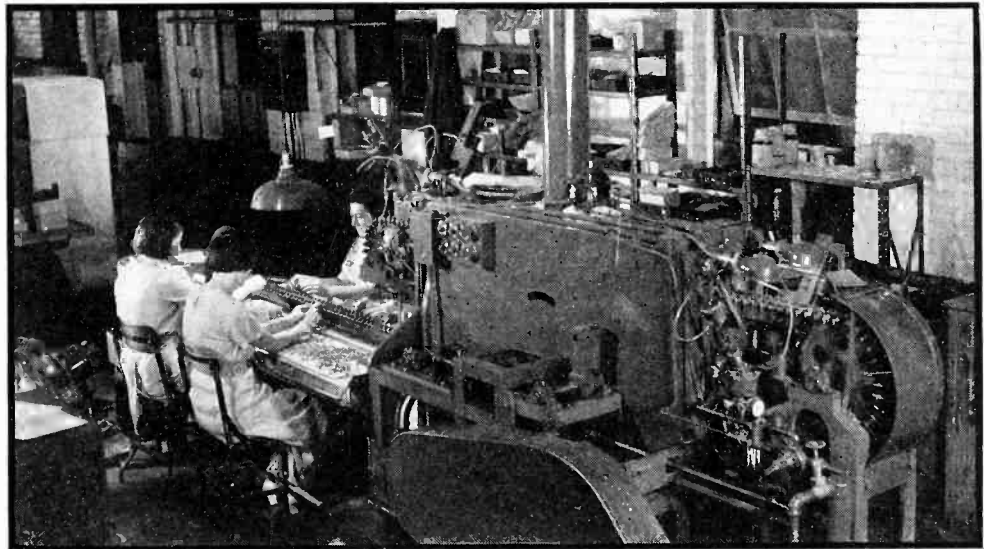

Fig. 8—Machine in which cement is applied to seal carbons and Ceramicons within their ceramic cases. Assembled units are placed in clips on the chain which carries them to gun stations where cement is applied and through ovens where the cement is set



Fig. 9—Apparatus used for checking the capacity and power factor of condensers as the latter are held in a clip at the left of the panel. A dial with limit settings facilitates the measurements

Behavior of Half-Wave Rectifiers

The wave forms of the output voltage and current of a half-wave rectifier with various types of load are analyzed by means of Fourier's series. The d-c, fundamental frequency and some harmonic terms are computed for the circuits discussed

HALF-WAVE single phase rectifiers have received rather wide use, but less than their share of analytical attention. An engineer looking for definite information on this circuit finds little available in textbooks and the technical literature, and, even worse, he must treat what he does find with care, for it may be incorrect. Current wave forms for a few circuits were derived in an article¹ in a recent issue of *Electronics*, but in a way different from the present study. The analyses presented here are an outgrowth of previous work with full-wave circuits,² and are made by means of a Fourier series representation of voltage and current wave forms. The series method need not be advanced as the best for all situations, but it does have advantages for many rectifier and filter cases. It is a convenient way to express recurring wave forms. Also, if the voltage at the input terminals of the rectifier load circuit is expressed properly by a series, the corresponding current series can be obtained by applying to each voltage term the impedance of the circuit for that frequency. The series method can be applied to multi-section filters for which the differential equation or the operational method is difficult, and moreover, has the virtue of showing directly the harmonic components. The analyses given here show the wave form and the series terms for the circuit input voltage, as well as for the current, as the input voltage takes many forms with a half-wave rectifier, depending upon the type of load.

Electrical rectifiers have often been termed valves to indicate the analogous condition of one-way flow met with a check valve in a water pipe. The rectifier might also be called a switch which has been "trained" to open whenever the current tries to flow in the reverse of

the preferred direction. The switch concept is useful, in visualizing the fact that events in the load circuit while the rectifier is non-conducting are independent of the a-c supply line, and depend only on the load circuit. Such non-conducting periods occur for some loads with a single phase full-wave rectifier or even with a polyphase rectifier, but they always occur with a single phase half-wave rectifier as conduction cannot continue for a complete cycle in any practical circuit.

Curves are presented to show the behavior of a half-wave rectifier with several types of load. The results shown here are computed on the basis of a perfect rectifier, that is, a rectifier having zero voltage drop across it for conduction periods and zero reverse current for non-conduction periods. A power supply of sinusoidal wave form and negligible impedance is also assumed. The perfect rectifier is used here as it is desired to show general circuit characteristics rather than the peculiarities of any particular type of rectifier. However, rectifier imperfections can be taken into account approximately in particular cases. A gaseous rectifier may be approximated by a constant voltage drop for the conduction periods. A vacuum rectifier may be

replaced by a perfect rectifier plus a resistance to a fair degree of approximation if the tube drop is small compared with the load voltage.

Discussion of the Curves

Figure 1 shows the case of a purely resistive load. The current and the voltage e' follow the sinusoidal pattern for the half cycle from 0° to 180° , and then are zero from 180° to 360° . The equations show the first few terms of the series for e' and i to represent this form of variation. We see a constant or d-c term, a very large term of line (or "fundamental") frequency, and smaller amounts of various multiples of this frequency. The difference between e and e' shown by the curves during the non-conduction period is significant physically as the inverse voltage across the rectifier.

Figure 2 shows the current in a circuit consisting of resistance and inductance in series. It will be seen that conduction continues beyond the 180° point due to the induced emf of the inductance. For the constants used in this case the "switch" opens at about 304° , so e' follows the sinusoidal form until that point is reached, and is zero for the remainder of the cycle. The average value of the e' curve (which is the

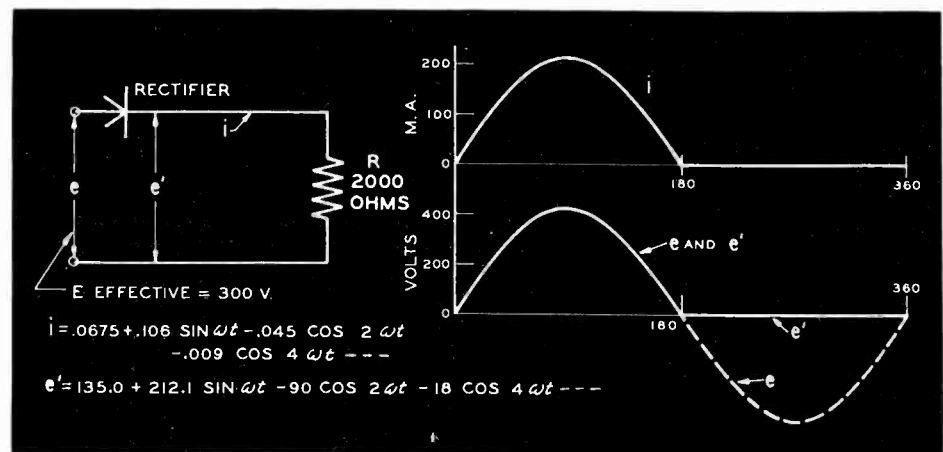

Fig. 1—Curves for the case of a pure resistance load. The equations give the d-c, fundamental and harmonic terms

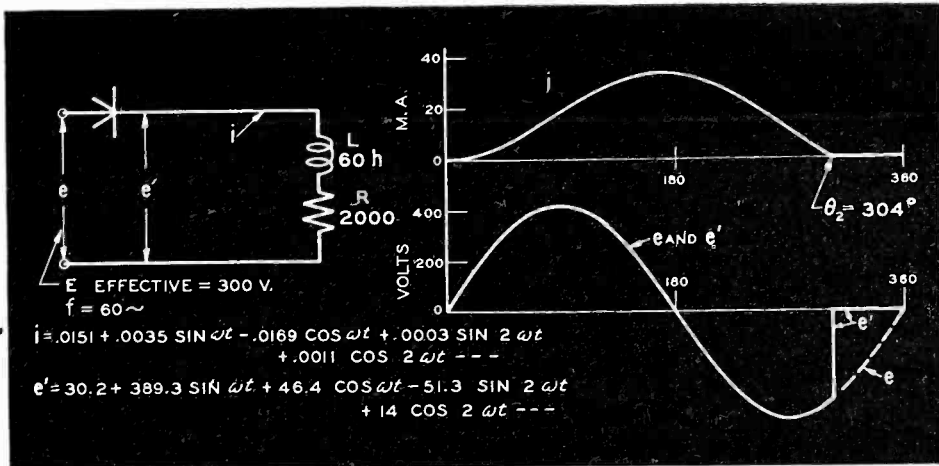

Fig. 2—The effect of inductance in the load circuit is to increase the period of conduction

By
M. B. STOUT
University of Michigan

rather poorly in the graph; it is of course similar in form to e'

Figure 4 shows a simple form of filter circuit. Here, as in Fig. 2, the inductance causes conduction to continue far beyond the 180° point. After θ_2 there is an exponential section, for the same reason as in Fig. 3. The smoothing effect of the circuit on the load (i_R) is shown by both the equation and the curve; the condenser takes the major part of the alternating current through L . The voltage e' has a small d-c component, and a very large fundamental frequency term (85 per cent greater than in Fig. 1).

Figure 5 shows a circuit which is essentially the same as one reported by a contributor to *Electronics*³ with values modified. The applied voltage has been multiplied by 20 and all impedances by 100, to make the case comparable with the others presented here. The proportions remain as in the reported case, but the current should be one-fifth as great. No attempt is made to correct for rectifier imperfections as no data were given regarding the rectifier characteristics. The constants of the circuit, with S open, are the same as in Fig. 2, so the effect of closing the switch may be found by comparison of Fig. 2 and Fig. 5. The circuit as a whole gives a more nearly resistive effect with S closed and conduction lasts only to 186°. After 186°, e' has a negative exponential section, due to the decreasing current through the coil and R_2 . In this case e' has an average value nearly four times as great as in Fig. 2, and the total circuit resistance is lower, so that the total current (average value) is about five times as great. The average coil current is half of the total or about 2.5 times as great as in Fig. 2. It is also much smoother in form. The observed increase of coil current upon closing S seems unreasonable if R_2 is consid-

SUBSCRIPTION ORDER CARD

Enter my subscription for **ELECTRONICS** and send me bill:

One year for \$5.00 Three years for \$10.00

Name _____

Street and No. _____

City and State _____

Firm _____ Position _____

(Subscriptions quoted for U. S. and Possessions, Canada, Central and South America, \$1.00 additional per year for foreign)

Printed in U.S.A.

9-39

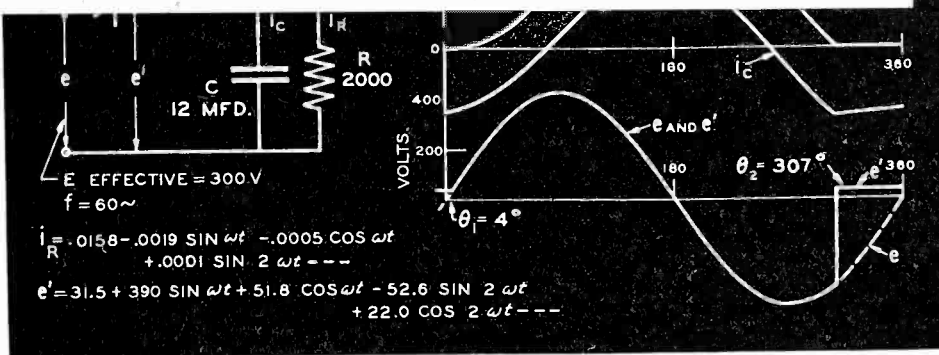

Fig. 4—A simple filter circuit causes the conduction period to continue to beyond the 300 degree point

d-c voltage component) is much smaller than in the first case, as may be checked by inspection of the curve. The average value of i , which is equal to the average value of e' divided by R , is also much less than in Fig. 1. Another striking difference, compared with Fig. 1, is the great increase of the fundamental frequency component of e' .

Figure 3 shows the effect of placing a condenser in parallel with a

resistance. Conduction through the rectifier ceases at the point θ_2 , where the total current tends to reverse. After θ_2 , e' follows an exponential decrease until it meets the sinusoidal e at $360^\circ + \theta_1$. In this case e' has a much greater average value than in Fig. 1, and a smaller harmonic content, as might be expected from its smaller range of fluctuation. The conduction period in this case is about 62°. The current i_R shows

Behavior of Half-Wave Rectifiers

The wave forms of the output voltage and current of a half-wave rectifier with various types of load are analyzed by means of Fourier's series. The d-c, fundamental frequency and some harmonic terms are computed for the circuits discussed

HALF-WAVE single phase rectifiers have received rather wide use, but less than their share of analytical attention. An engineer looking for definite information on this circuit finds little available in textbooks and the technical literature, and, even worse, he must treat what he does find with care, for it may be incorrect. Current wave forms for a few circuits were derived in an article¹ in a recent issue of *Electronics*, but in a way different from the present study. The analyses presented here are an outgrowth of previous work with full-wave circuits,² and are made by means of a Fourier series representation of voltage and current wave forms. The series method need not be advanced as the best for all situations, but it does have advantages for many rectifier and filter cases. It is a convenient way to express recurring wave forms. Also, if the voltage at the input terminals of the rectifier load circuit is expressed properly by a series, the corresponding current series can be obtained by applying to each voltage term the impedance of the circuit for that frequency. The series method can be applied to multi-section filters for which the differential equation or the operational method is difficult, and moreover, has the virtue of showing directly the harmonic components. The analyses given here show the wave form and the series terms for the circuit input voltage, as well as for the current, as the input voltage takes many forms with a half-wave rectifier, depending upon the type of load.

Electrical rectifiers have often been termed valves to indicate the analogous condition of one-way flow met with a check valve in a water pipe. The rectifier might also be called a switch which has been "trained" to open whenever the current tries to flow in the reverse of

the preferred concept, the fact that while they are independent line, and circuit. They occur for phase f with a polyphase rectifier, but they always occur with a single phase half-wave rectifier as conduction cannot continue for a complete cycle in any practical circuit.

Curves are presented to show the behavior of a half-wave rectifier with several types of load. The results shown here are computed on the basis of a perfect rectifier, that is, a rectifier having zero voltage drop across it for conduction periods and zero reverse current for non-conduction periods. A power supply of sinusoidal wave form and negligible impedance is also assumed. The perfect rectifier is used here as it is desired to show general circuit characteristics rather than the peculiarities of any particular type of rectifier. However, rectifier imperfections can be taken into account approximately in particular cases. A gaseous rectifier may be approximated by a constant voltage drop for the conduction periods. A vacuum rectifier may be

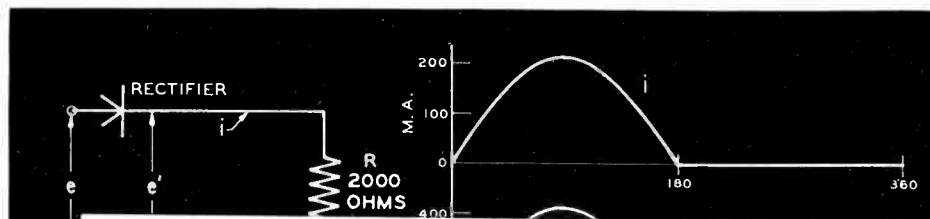

Postage
Will be Paid
by
McGraw-Hill
Pub. Co.

No Postage
Stamp Necessary
If Mailed
in the
United States

BUSINESS REPLY CARD
First Class Permit No. 64 (Sec. 510, P. L. & R.) New York, N. Y.

ELECTRONICS

McGraw-Hill Publishing Co., Inc.

330 WEST 42nd STREET,

NEW YORK, N. Y.

usual pattern for the half cycle from 0° to 180° , and then are zero from 180° to 360° . The equations show the first few terms of the series for e' and i to represent this form of variation. We see a constant or d-c term, a very large term of line (or "fundamental") frequency, and smaller amounts of various multiples of this frequency. The difference between e and e' shown by the curves during the non-conduction period is significant physically as the inverse voltage across the rectifier.

Figure 2 shows the current in a circuit consisting of resistance and inductance in series. It will be seen that conduction continues beyond the 180° point due to the induced emf of the inductance. For the constants used in this case the "switch" opens at about 304° , so e' follows the sinusoidal form until that point is reached, and is zero for the remainder of the cycle. The average value of the e' curve (which is the

By
M. B. STOUT
University of Michigan

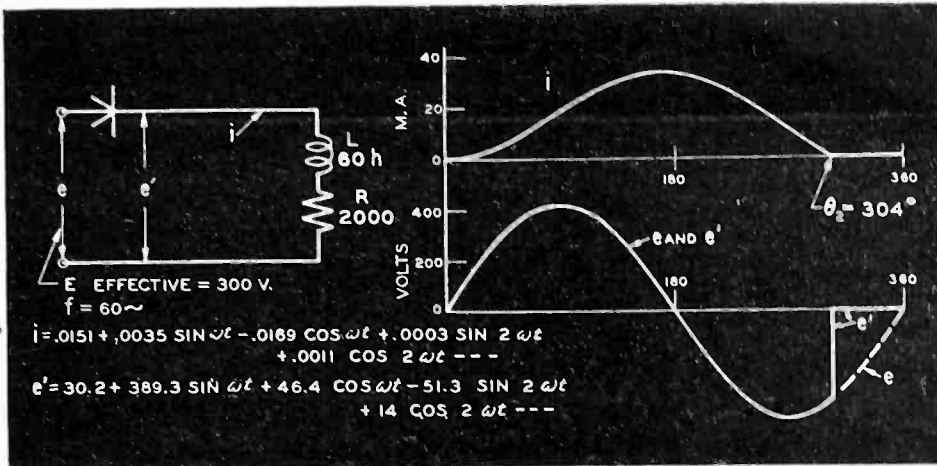

Fig. 2—The effect of inductance in the load circuit is to increase the period of conduction

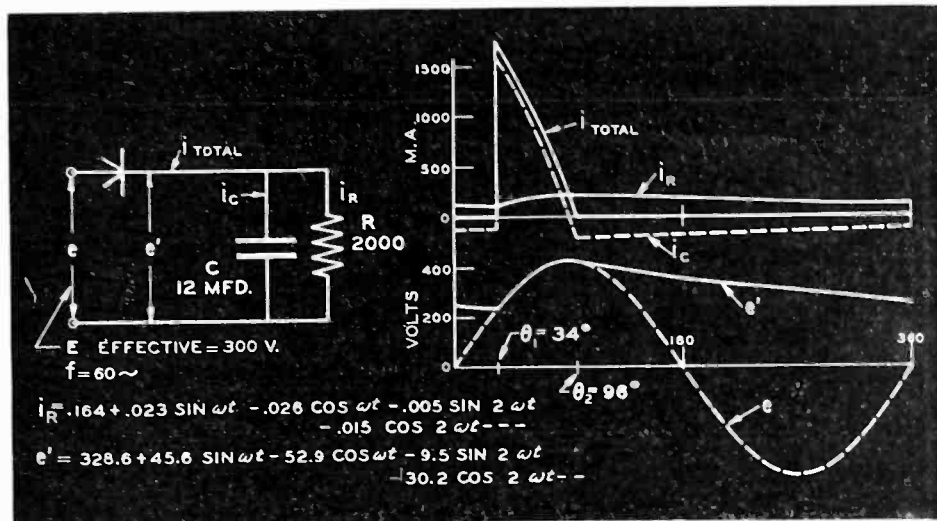

Fig. 3—When a capacity is in parallel with a resistance, the conduction period is decreased, but there is a continuous flow of current through the resistance

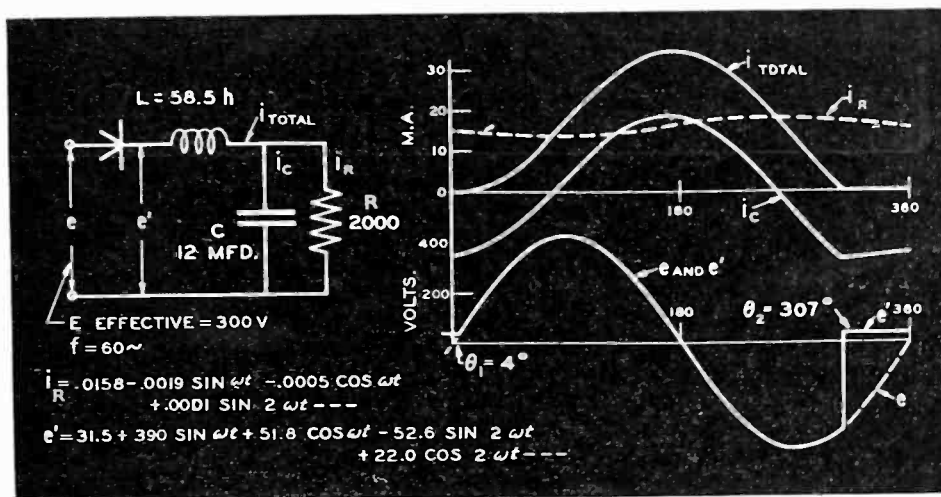

Fig. 4—A simple filter circuit causes the conduction period to continue to beyond the 300 degree point

d-c voltage component) is much smaller than in the first case, as may be checked by inspection of the curve. The average value of i , which is equal to the average value of e' divided by R , is also much less than in Fig. 1. Another striking difference, compared with Fig. 1, is the great increase of the fundamental frequency component of e' .

Figure 3 shows the effect of placing a condenser in parallel with a

resistance. Conduction through the rectifier ceases at the point θ_2 , where the total current tends to reverse. After θ_2 , e' follows an exponential decrease until it meets the sinusoidal e at $360^\circ + \theta_1$. In this case e' has a much greater average value than in Fig. 1, and a smaller harmonic content, as might be expected from its smaller range of fluctuation. The conduction period in this case is about 62° . The current i_R shows

rather poorly in the graph; it is of course similar in form to e'

Figure 4 shows a simple form of filter circuit. Here, as in Fig. 2, the inductance causes conduction to continue far beyond the 180° point. After θ_2 there is an exponential section, for the same reason as in Fig. 3. The smoothing effect of the circuit on the load (i_R) is shown by both the equation and the curve; the condenser takes the major part of the alternating current through L . The voltage e' has a small d-c component, and a very large fundamental frequency term (85 per cent greater than in Fig. 1).

Figure 5 shows a circuit which is essentially the same as one reported by a contributor to *Electronics*³ with values modified. The applied voltage has been multiplied by 20 and all impedances by 100, to make the case comparable with the others presented here. The proportions remain as in the reported case, but the current should be one-fifth as great. No attempt is made to correct for rectifier imperfections as no data were given regarding the rectifier characteristics. The constants of the circuit, with S open, are the same as in Fig. 2, so the effect of closing the switch may be found by comparison of Fig. 2 and Fig. 5. The circuit as a whole gives a more nearly resistive effect with S closed and conduction lasts only to 186° . After 186° , e' has a negative exponential section, due to the decreasing current through the coil and R_2 . In this case e' has an average value nearly four times as great as in Fig. 2, and the total circuit resistance is lower, so that the total current (average value) is about five times as great. The average coil current is half of the total or about 2.5 times as great as in Fig. 2. It is also much smoother in form. The observed increase of coil current upon closing S seems unreasonable if R_2 is consid-

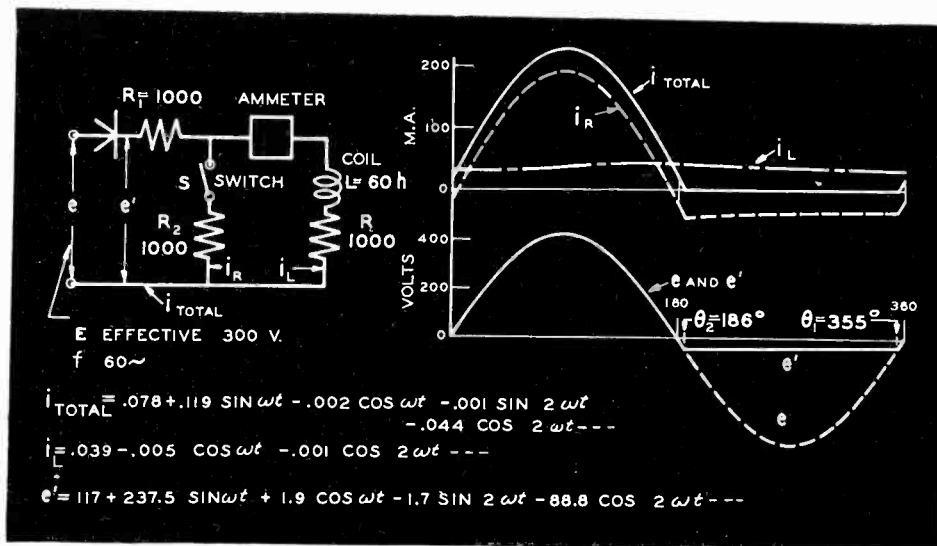

Fig. 5—Resistance, R_2 , provides a discharge path for the inductance, confining the conduction period to the range between zero and 186 degrees

ered only as a shunt which diverts current from the coil. The influence of R_2 on wave forms is of greater importance in this circuit, as becomes evident upon a study of the change in conducting period of the rectifier. Physically, R_2 might be visualized as providing a discharge path for the inductance, thus enabling the rectifier to shut off near the 180° point, and so not subject L to the negative supply line voltage during the half cycle from 180° to 360°, as in Fig. 2.

The table gives a summary of the harmonic components of the circuit input voltage e' for the five cases presented. In this table the sine and cosine terms of each frequency are combined to show the total amplitude. All components show great differences between the various cases, but the greatest interest attaches, in general, to the d-c and the fundamental frequency parts. The d-c term ranges from 30 to 328 volts, and the fundamental from 70 to 392 volts. This table illustrates the point that no one set of harmonic values can be given as representative of conditions on a half-wave rectifier. The voltage equation of Fig. 1 is the one usually referred to in text books as the voltage of a half-wave rectifier; it should be used, however, only in the special case of a resistive load.

A detailed description of the procedure followed in deriving the equations would extend this article unduly. The method, in general, is a modification of that presented for full-wave rectifiers in an article already mentioned.² The circuit behavior can be determined qualita-

tively from general circuit considerations and a voltage series derived by the necessary combination of sinusoidal sections, exponential sections, etc. In case the point of transition from one section to another

TABLE I—Amplitudes of the harmonic components of the circuit input voltage, e' (maximum values), of Figs. 1 to 5. The supply voltage is 300 volts (effective)

Harmonic	Fig. 1 Load = R	Fig. 2 L, R	Fig. 3 C, R	Fig. 4 L, C, R	Fig. 5 R, L shunted
D-C Term	135.0	30.2	328.6	31.5	117.0
1 (Fundamental)	212.1	392.1	69.8	393.4	237.5
2	90.0	53.3	31.7	57.0	89.9
3	0	46.4	17.7	49.3	8.5
4	18.0	37.9	10.2	40.0	16.8
5	0	29.8	5.8	30.2	5.0
6	7.7	20.8	3.3	21.6	6.5
Conduction Period	180°	304°	62°	303°	191°

is now known, it can be found by a trial solution, or by other methods. The current series is derived from the voltage series, and checked to see that the total current is zero during the non-conducting period.

Applications of the Method

The series form of representation of the circuit input voltage is useful in many ways, as it shows not only the d-c component, but also the frequencies and amplitudes of the harmonics which are present. A major use is in the study of filter circuits in which the load, or output, ripple can be computed for any harmonic, knowing the input ripple and the circuit constants. However, it must be emphasized again that the input ripple differs for practically every load connected to a half-wave rectifier, as indicated by the table, and

that accuracy of output ripple is obtained only when the correct input value is used. References can be cited⁴ in which the proportions of the conventional half-wave voltage of Fig. 1 are given as the proper values for a filter circuit. In another case⁵ the same curves are presented for either choke-input or condenser-input filters, with no distinction as to the input ripple in the two cases—which is not correct, even for a full-wave rectifier; also, curves are shown for odd harmonics, implying use of the chart for half-wave rectifiers, but nothing is given either to help find the input voltage harmonics, or even to point out that a problem is involved in finding them. Harmonic terms have been computed for several circuits, and the results compared with published material; often errors of 50 to 100 per cent have been found, and occasionally much larger amounts. The errors are due in part to the use of in-

correct input harmonics, and in part to discrepancies in the assumptions on which the published curves are based.

Conclusions

1. The wave form and the harmonic make-up of the voltage from a half-wave rectifier depend on the load connected to it.
2. The effect of circuit changes, as in Fig. 5, can be understood only by a study of the wave-form changes.
3. Filter ripples based on the harmonic terms of Fig. 1, are incorrect for actual filter circuits.

¹ Half-Wave Gas Rectifier Circuits, C. M. Wallis, *Electronics*, Oct. 1938, p. 12.

² Analysis of Rectifier Filter Circuits, M. B. Stout, *Elec. Eng.*, Sept. 1935, p. 977.

³ Problem, Crosstalk, *Electronics*, May 1938, p. 7.

⁴ "Rectifier Filter Circuits," Reuben Lee, *Elec. Jour.*, April 1932, p. 186.

⁵ Power Supply Filter Curves, W. W. Waltz, *Electronics Reference Sheet*, *Electronics*, Dec. 1935.

Compensated Amplifier Chart

By Y. J. LIU and J. D. TRIMMER

Massachusetts Institute of Technology

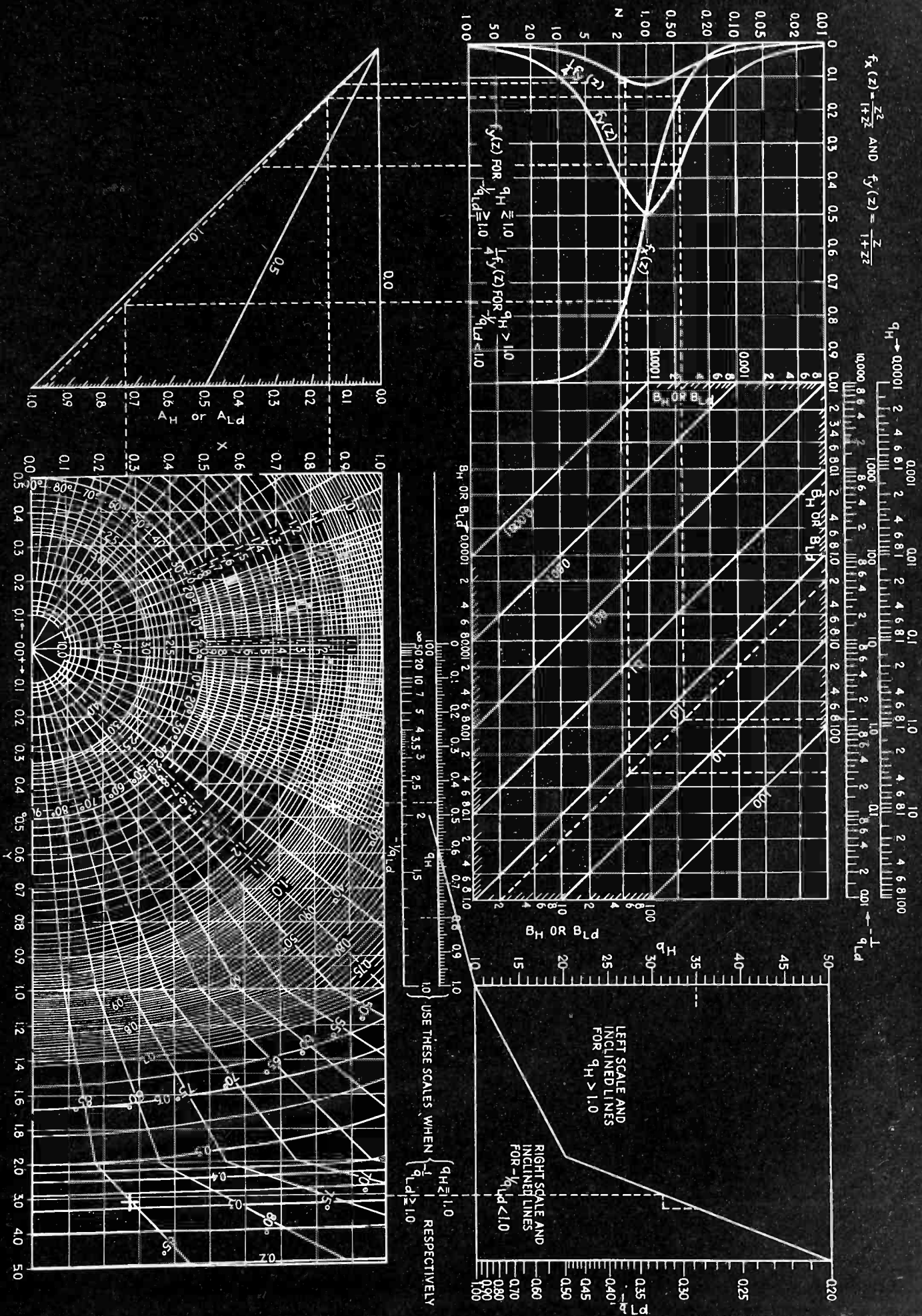

Compensated Amplifier Chart

THE accompanying chart is designed to give relative values of the gain and phase shift of one stage of a resistance coupled amplifier which is compensated by addition of certain elements to its load impedance. The actual and equivalent circuits of such an amplifier stage are shown in Fig. 1. The chart is based on the equivalent circuit, which includes in the shunt capacitance C_s , the inter-electrode capacitances of the tube and stray wiring capacitance of the coupling circuit.

The gain of the amplifier stage and also the phase shift between E_o and E_i can be determined so that $(A_r/A_r = 1/\sqrt{X^2 + Y^2})$ and $\theta_r = \tan^{-1}(Y/X)$, where A_r is the gain at any frequency f and A_r is some particular value of gain used for reference; θ_r is the angle of phase shift between E_o and E_i , positive when E_o lags behind E_i ; and X and Y are quantities depending on frequency and on the various circuit elements.

The expressions for X and Y can be simplified, for very high frequencies and for very low frequencies, to the same form, with parameters q , A and B to be defined later,

$$X = 1 - A \frac{(q/B)^2}{1 + (q/B)^2} \quad (1)$$

$$Y = q - A \frac{q/B}{1 + (q/B)^2} \quad (2)$$

The chart is simply a graphical method of finding X and Y for any given values of q , A and B and also of finding A_r/A_r and θ_r for any values of X and Y .

The simplified forms of Equations (1) and (2) are obtained, naturally, only by making certain assumptions. Explicitly stated, these assumptions are: First, the ratio C_s/C_c is considered so small compared to one that it may be neglected. Second, $L/C_d R_d R_c$ is much smaller than one. Third, R_c and R_d are of the same order of magnitude. Fourth, the time constants $C_d R_d$ and $C_c R_c$ are of the same order of magnitude. These four conditions are easily met in design practice and do not restrict the usefulness of the method.

The values of q , A and B for use in Equations (1) and (2) and in the chart may be defined more conveni-

By Y. J. Liu and J. D. Trimmer
Massachusetts Institute of Technology

ently by first defining the resistances:

$$R_H = \frac{1}{\frac{1}{R_v} + \frac{1}{R_p} + \frac{1}{R_c}}$$

$$R_L = R_v + \frac{1}{\frac{1}{R_p} + \frac{1}{R_c}}$$

$$R_{Ld} = R_L \left[1 + \frac{R_o R_d}{R_c (R_c + R_p + R_d)} \right]$$

where the subscripts H , L and Ld refer, respectively, to high frequencies, low frequencies, and low frequencies with decoupling.

Then for high frequencies,

$$q_H = 2\pi f C_s R_H$$

$$A_H = R_H / R_c$$

$$B_H = (C_s R_H R_c) / L$$

and for low frequencies,

$$q_{Ld} = -1 / 2\pi f C_c R_{Ld}$$

$$A_{Ld} = \frac{R_d R_p R_o}{R_{Ld} R_c (R_c + R_p + R_d)}$$

$$\left[1 - \frac{C_d R_d R_c}{C_c R_o (R_c + R_d)} \right]$$

$$B_{Ld} = \frac{C_d R_d R_c}{C_c R_{Ld} (R_o + R_d)}$$

As previously stated, the value of A_r/A_r is given on the chart. The reference value is $A_r = R_H / R_c$. This, multiplied by the tube's amplification factor, is the gain of the uncompensated amplifier in its medium fre-

quency range, and, if compensating elements are chosen in accord with the conditions listed above, it is also very closely the gain of the compensated amplifier in its medium frequency range.

The dotted lines on Fig. 2 serve to illustrate the use of the chart. Suppose the high frequency parameters are $A_H = 0.96$ and $B_H = 2.0$. The dotted lines show how values of gain and phase angle are found for two different values of q_H , that is, for two different frequencies.

The first step is to locate the value of q_H on the horizontal scale at top center of the chart. Starting with $q_H = 0.8$ and projecting down to the inclined line drawn for $B_H = 2.0$, the projection is then to the left and on to the two curves $f_x(z)$ and $f_y(z)$, thence downward to the inclined line drawn for $A_H = 0.96$. Of the two projections, the one from $f_x(z)$ is carried to the right; the other is used to establish the distance below the line $A_H = 0$. This distance is picked up and laid off, on the q_H -scale in the center of the chart, to the left of the point $q_H = 0.8$. Projection downward then gives an intersection establishing values of X and Y , and also of gain and phase shift. Here $X = 0.855$, $Y = 0.465$, relative gain is 1.027 and phase shift is 28.9 degrees.

The procedure for $q_H = 3.5$ (q_H greater than one) differs in two respects from the above (q_H less than one). In the upper left of the chart, the $f_x(z)$ curve is used instead of $f_y(z)$, and the length picked up from the projection from this curve to the A_H -line is laid off along the vertical q_H -scale. Thus the relative gain is found to be 0.322 and the phase shift 85 degrees.

For high frequencies, positive phase angles read from the chart mean lagging of the output relative to the input voltage. For low frequencies, positive angles on the chart mean leading of the output voltage.

For convenience in using the low frequency parameters, the frequency scales are plotted in terms of $-1/q_{Ld}$, which is directly proportional to frequency; that is $-1/q_{Ld} = 2\pi f C_c R_{Ld}$.

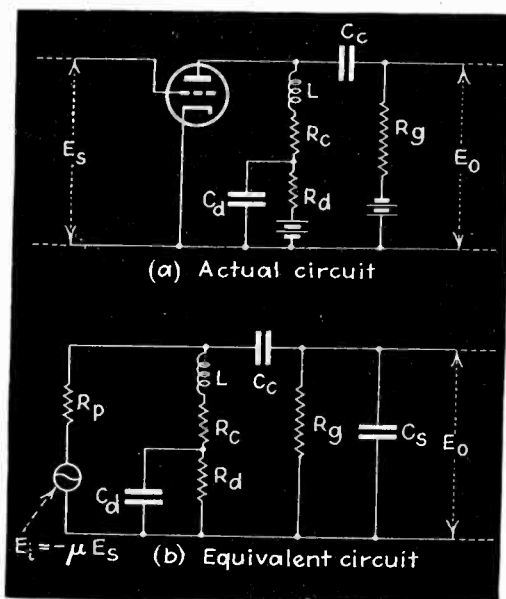

Fig. 1—Actual and equivalent amplifier circuits

CINCH MAKES A GOOD CONNECTION... ALL-WAYS

8114 Insulator 8114 Connector
(Front View)

M-95

8114 Connector 8114 Insulator
(Back View)

M-95

"Cinch" features in each connector
—for example, note ceramic insu-
lator in connector as shown below.

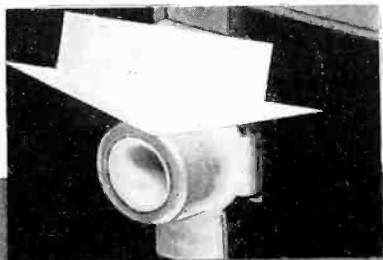

CINCH shielded connectors give positive and constant contact. Phonograph pick-up, antenna, voice-coil, "A" leads, connectors for every purpose—positive connections always and all ways. Even when subjected to the most severe vibrations, these connectors provide a constant electrical connection. The parts M-93, 1144 and 2811 as pictured below, comprise a perfectly shielded "cable break." Developed to meet most rigid requirements with specific advantages for your need, these connectors make "Cinch" a good connection.

*Cinch and Oak Radio Sockets are licensed under
H. H. Eby socket patents*

CINCH MANUFACTURING CORPORATION
2335 WEST VAN BUREN STREET, CHICAGO, ILLINOIS
Subsidiary of United Carr Fastener Corp., Cambridge, Mass.

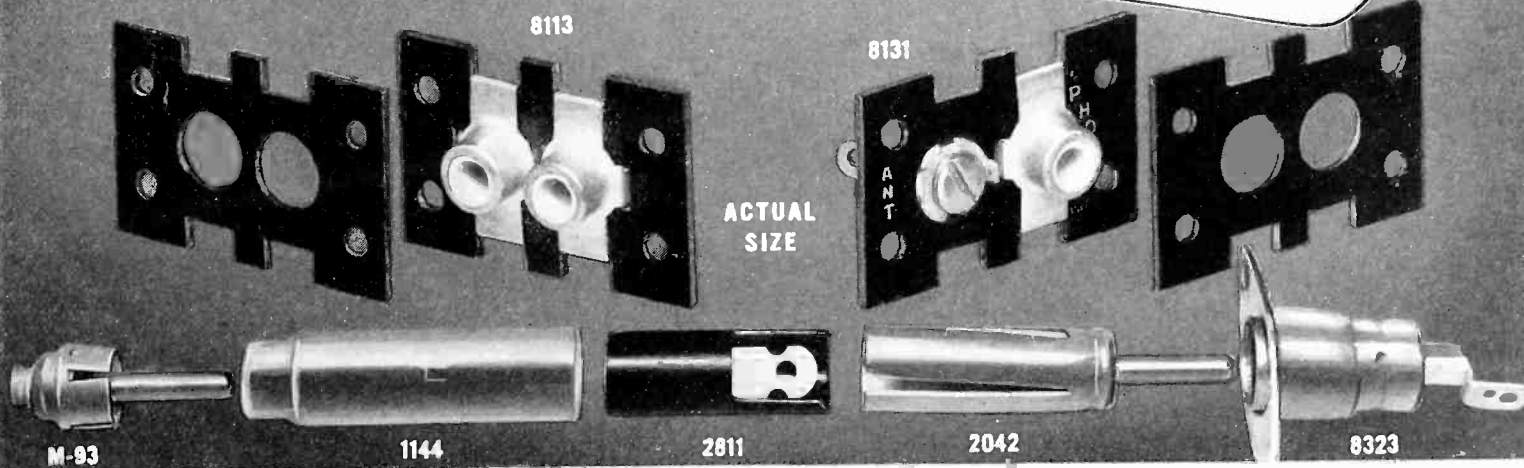

TUBES AT WORK

Among the subjects discussed this month are an ultra sensitive bridge, a contactless volume control, two phototube applications, a hiss silencer, projection television, and photoelectric effects on neon tubes

An Ultra-Sensitive Bridge

By JO EMMETT JENNINGS

IN THE FIELD of electronics and other fields of research, there is a constant need for a highly sensitive instrument which has an extremely high input impedance as well as a low power requirement for operation. An instrument to fill these requirements is the vacuum tube bridge, which can measure to 10^{-8}

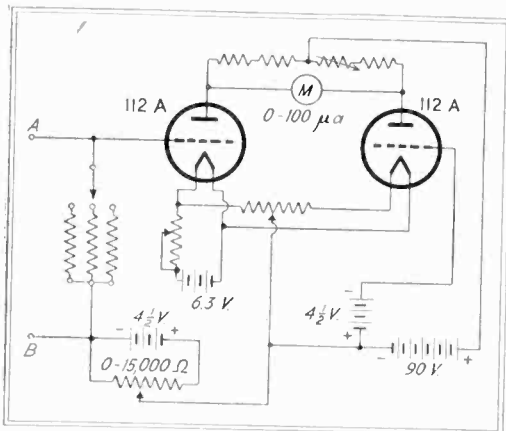

Fig. 1—Original circuit designed for the measurement of bioelectric phenomena

amperes. The purpose of this particular model is for measuring vacuum by means of positive ion collection at the anode of a radio tube.

Operation of the Bridge

An article published in *Electronics* in October 1936 by Burr, Lane and Nims describes a direct current operated bridge which was designed to measure bioelectric phenomena. The original circuit is shown in Fig. 1, and the shielded unit consisted of the bridge and batteries to eliminate the external electrical forces which might upset the balance. Type 112A tubes were used in the circuit as they were the best available at the time the unit was designed. The operation is normal and the adjustment simple if one principle is clearly understood. In a triode vacuum tube with proper adjustment it is possible for the grid to require no power and is at an equilibrium. This is known as the floating grid condition. In actual operation the grid voltage applied externally is exactly equal to voltage or potential the grid would seek if it were not connected in the circuit.

Figure 2 shows the complete diagram. R_1 (5000 ohms) is the plate balancing resistor; R_2 (20,000 ohms) is the bias control. A switch changes the 0-100 microammeter to the 0-20 microammeter. For the operator who is not thoroughly familiar with sensitive meters it is a good idea to use a variable shunt across the meter to avoid damage to the sensitive movement. To arrive at the proper grid bias practically, it is necessary to first set the variable plate balance resistor R_1 at approximately the same resistance as the fixed resistance in the plate lead of the other tube. R_2 is next adjusted and set at a point where the meter is at zero. The input selector switch is rotated from low to high resistance. Should there be any movement of the meter the grid is not balanced and the plate and grid controls must be readjusted until no movement occurs when the input switch is rotated.

Problems in Design

An experimental model was constructed adapting the circuit in Fig. 1, to be used on alternating current. The first of the problems encountered was the instability of the meter due to changes in line voltage. The addition of an 876 ballast tube in conjunc-

tion with an autotransformer to supply the 65 volts lost in the tube did not completely solve the problem of regulation, as there was a slight change in voltage which operated the bridge. Of the numerous types of gaseous type voltage control tubes the 874 was finally selected as the most practical of the group. In the circuit for testing the gas, shown in Fig. 3, it was necessary to have a well regulated supply as the grid current is constantly being varied. The autotransformer had

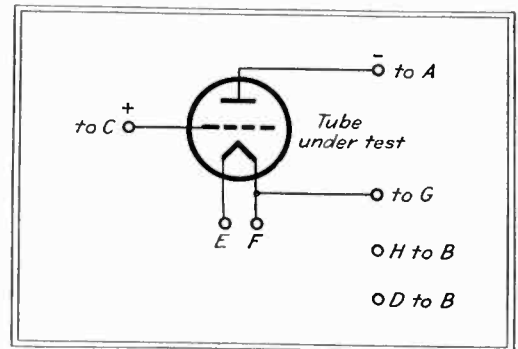

Fig. 3—Gas testing circuit

all the qualifications except that its magnetic field threw the bridge completely out of adjustment when the arm was varied. A large shield was used to isolate the transformer. In the experimental model using the 112A tubes, no position of the balancing resistors would give a perfect balance of the bridge. The cause was finally attributed to the leakage in the tube base which was made of bakelite. Even after the tubes were debased complete balance was impossible. Several 112A tubes were measured and found gassy. There was also the aging process which consisted of lighting the filament for 250 hours to stabilize the filament emission.

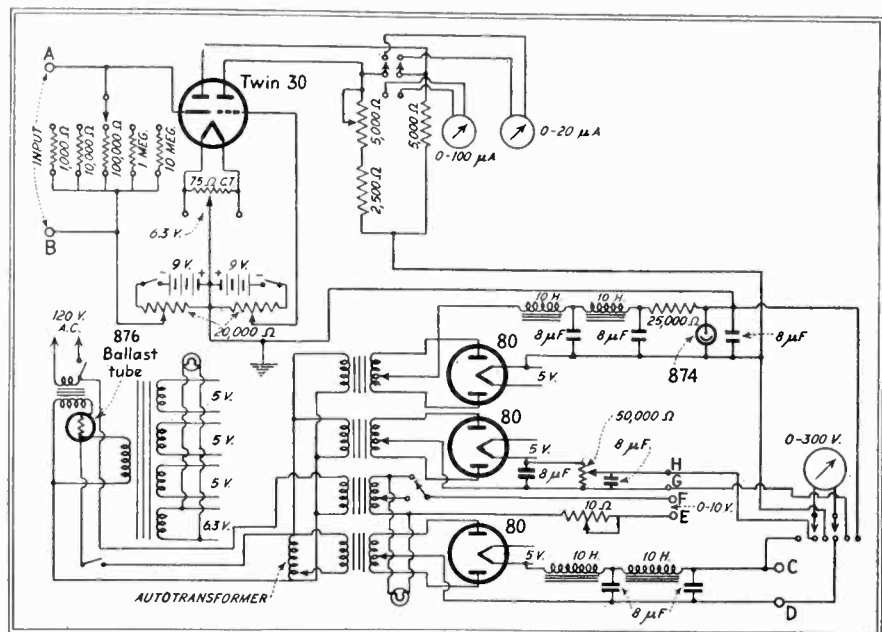
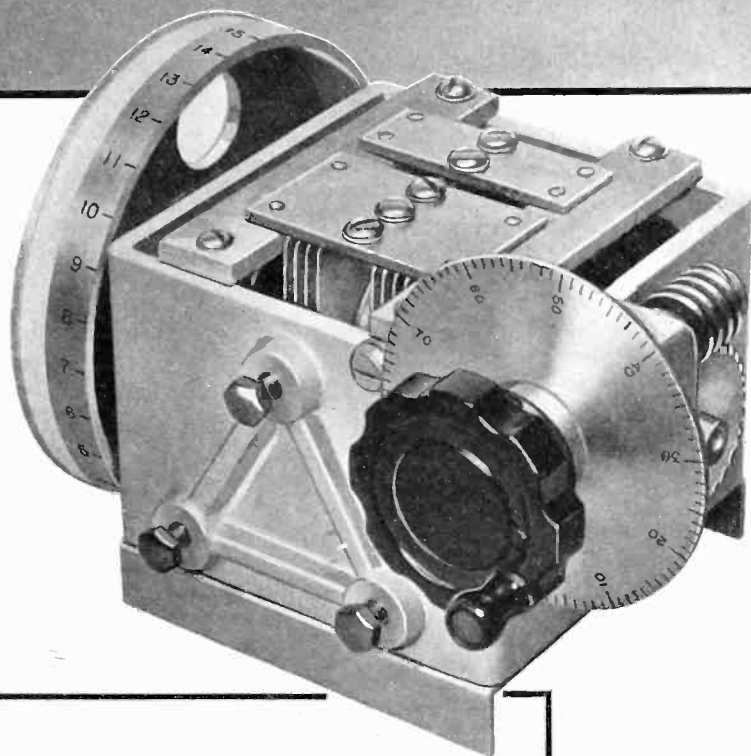
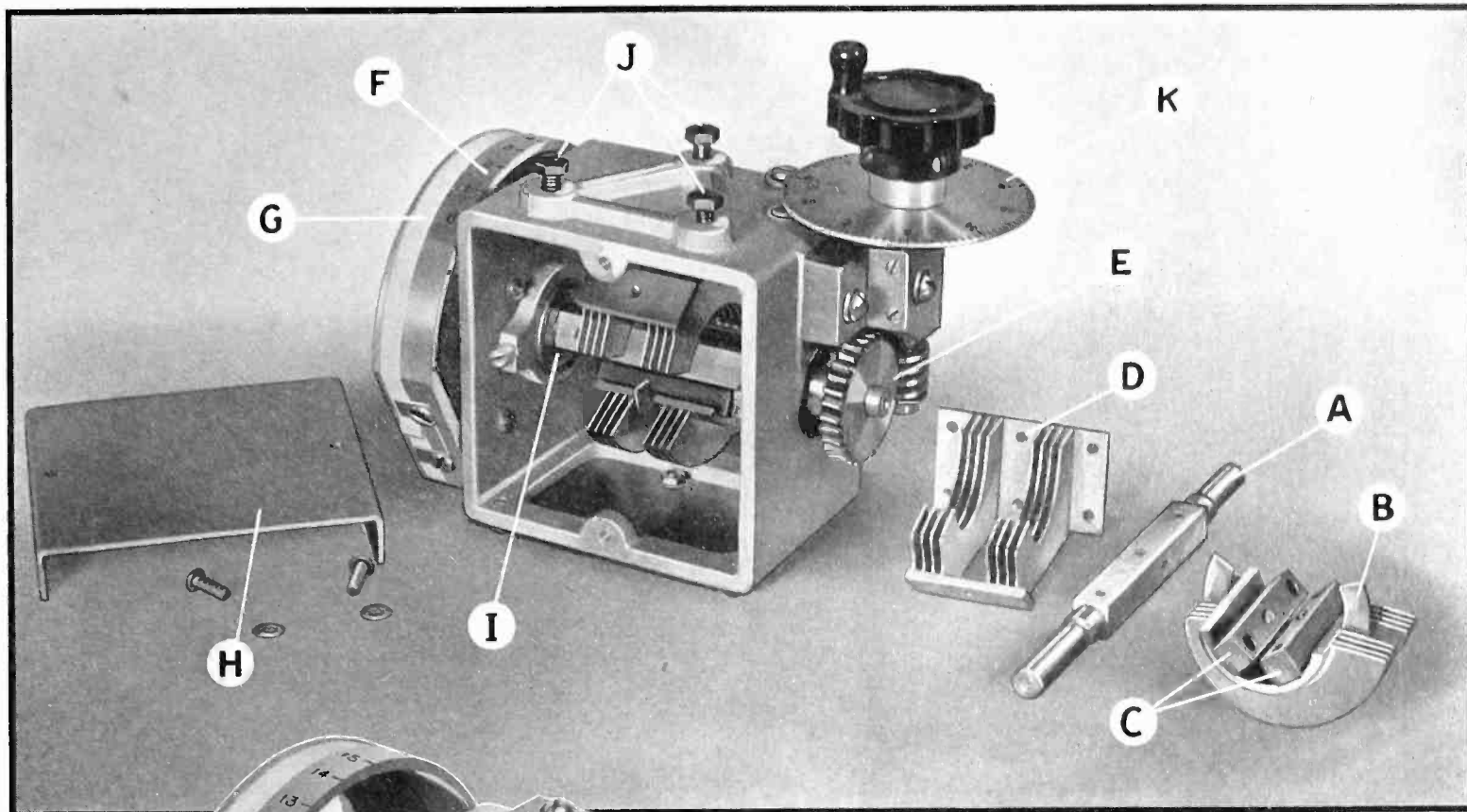

Fig. 2—Complete circuit diagram of the ultra-sensitive bridge



SPECIFICATIONS

Capacitance 8.5 μmf minimum, 145 μmf maximum; Equivalent series inductance 0.0055 μh ; Insulation Polystyrene and Mycalex; Rotor and stator plates insulated from ground; Three-hole panel mounting.

Type 755-A Condenser . . . \$35.00

New Variable Condenser

● FOR USE IN high- and ultra-high frequency circuits the new G-R Type 755-A Condenser fills a demand for a compact, precision-built, ruggedly constructed variable condenser with low losses, very low series inductance and low effective resistance.

FEATURES

- A Stainless steel rotor shaft
- B Rotor contact ring of nickel silver with pure silver overlay; 4-finger silver contact brush
- C Polystyrene rotor insulation; Mycalex stator insulation
- D Heavy, copper-plated, soldered brass rotor and stators
- E 30:1 precision worm drive with spring in indicator drum to prevent backlash
- F Drum scale engraved with 15 divisions
- G Removable paper scale for individual calibrations
- H Removable base plate and cover of nickel-plated brass
- I Ball bearings on main shaft
- J Heavy cast-aluminum box; 3-point panel suspension
- K Worm dial with 100 divisions on scale

• WRITE FOR BULLETIN 471 FOR COMPLETE DATA

GENERAL RADIO COMPANY CAMBRIDGE MASSACHUSETTS

SHALLCROSS Solid Silver Switches

Built to Our Own Exacting Specifications

Types 532 and 531 can be furnished with from 2 to 15 contacts with shorting or non-shortening contact arm of bronze or multi-leaf silver. Switch plates are ceramic with a surface leakage of 1×10^{12} ohms. Contact resistance with silver arm is only .00075 ohms. Contacts will safely break 15 amps. non-inductive load, and withstand 2000 V. For complete data on these high grade inexpensive switches write today for Bulletin 500 KI.

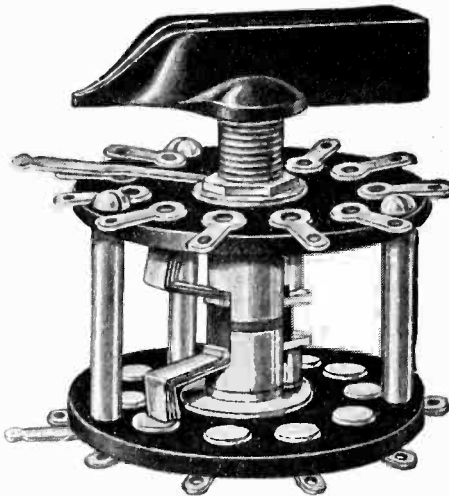

HIGH VOLTAGE RESISTORS

The new Shallcross tubular high voltage resistor with ceramic shell is designed specifically to be moisture-proof and dust-proof as it is hermetically sealed. May be subjected to high and low temperatures. It is manufactured with terminal facilities to suit any requirements. It can be furnished in one megohm to 30 megohms. Send for Bulletin 705-K.

SHALLCROSS MFG. COMPANY

COLLINGDALE PENNA.

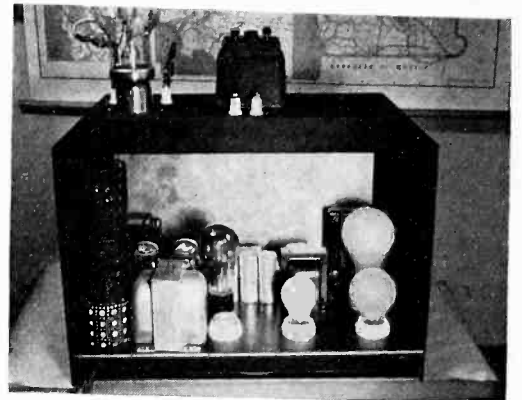

Fig. 4—Front and rear views of the bridge

With these ideas in mind a search was made for a simple tube which had stable emission, low leakage resistance between the grid and filament, and low resistance between the plate and grid. The Eimac "Twin"-30 was finally selected as the most suitable of all the tubes now manufactured. After its installation the bridge became very stable. In fact after two months of intermittent operation there is no trace of change in reading of the instrument.

• • •

A Contactless Volume Control

BY H. S. POLK

WHEN CONVENTIONAL RADIO type volume controls were used in electric organs with which the author had experience, they soon became noisy because of their almost continuous operation and because of their location in low level amplifier stages. To overcome this difficulty and also to allow for the placement of the control at a distance from the amplifier a new type of control was developed.

Briefly, volume control is achieved by varying the bias on one of the control grids of a variable μ tube. The variable bias is obtained by rectifying the output voltages produced by a special transformer in which the coupling between primary and secondary windings is adjustable over a wide range. Relative displacement of the windings is produced by adjustment of the swell pedal position which therefore controls volume level as in a pipe organ.

CHRYSLER TOWER

CBS TELEVISION ANTENNA

Another Achievement
of Isolantite's Cooperative Design Service

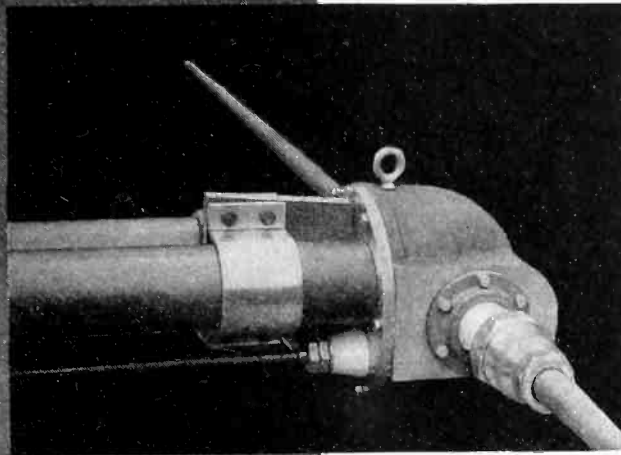

● An outstanding example of Isolantite's service and cooperation with other organizations is the Antenna System at Columbia Broadcasting's new television station in the Chrysler Tower. Through close collaboration with the engineers of CBS and RCA, this unique television antenna

system was produced. Starting with the fundamental electrical and physical requirements laid down by these engineers, Isolantite developed the mechanical design of the antenna in cooperation with CBS, and manufactured the entire system — dipole antennae, transmission lines, junction boxes, and matching equipment.

Service of this kind is typical of Isolantite's ability to offer consulting, design, and manufacturing experience to other organizations in the television and radio fields. In the design of a small insulating part or a complete antenna system, Isolantite's broad experience can be of assistance to you.

Both Isolantite* and the lower-loss Iso-Q for ultra high frequencies can be economically produced in new forms to meet changing trends in radio and television — and Isolantite constantly studies these trends to anticipate the requirements of the companies it serves. Let Isolantite's specialized knowledge help you in your own insulation problems.

*Registered Trade-name for the products of Isolantite Inc.

ISOLANTITE INC

CERAMIC INSULATORS

Factory: Belleville, N. J. • Sales Office: 233 Broadway, New York, N. Y.

What . . .
no
hum-m-m-m?



Ferranti design

Ferranti first introduced *HUM FREE TRANSFORMERS* and *INDUCTORS* for audio work. Then in view of the tremendous advantage resulting from the use of self-shielded transformers a further step was taken and *HUM FREE POWER TRANSFORMERS* and *FILTER CHOKES* were made available.

Today, in addition to hum free power and audio equipment this same construction is being applied to many special applications with remarkable results.

Whether your problem be the elimination of hum or any other engineering problem, Ferranti engineers can be of service, and you are obligated in no way.

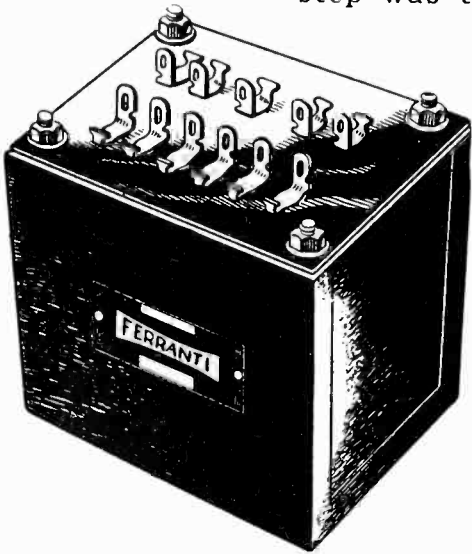

Ferranti
ELECTRIC
INCORPORATED
RCA BUILDING
NEW YORK, N. Y.

FOR
VALUE
RECEIVED

Referring to the accompanying figure the 6L7 tube is in one of the low level stages of the main organ amplifier. The signal voltage is fed to grid No. 1 and the amplified signal which is developed in the plate circuit is passed on to the next stage in the usual manner. The tube is pentode connected and provided with decoupling circuits in the screen and plate leads. The amplification is controlled by control of the bias on grid No. 3.

The variable coupling transformer is located in the back of the console, the primary winding being fixed in position and the secondary fastened to the swell pedal. The secondary voltage is rectified by the 6H6 double diode, filtered by resistors R_1 and R_2 and condensers C_1 and C_2 , and applied to the volume control grid of the 6L7. For a densers C_1 and C_2 , and applied to the depressed in front bringing the primary and secondary into closer proximity and thereby increasing the secondary voltage and d-c bias. Conversely when the amplifier gain is to be increased the foot pedal is moved to a more nearly horizontal position. This decreases the coefficient of coupling, secondary voltage and grid bias.

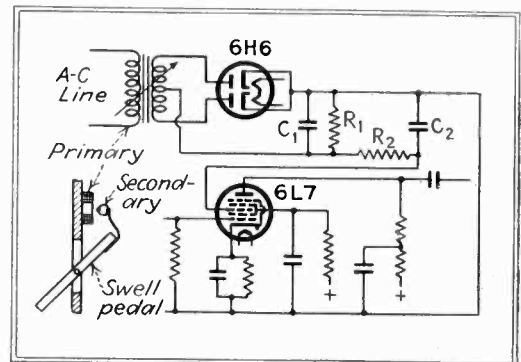

The variable coupling transformer provides control of volume

The transformer primary has an air core into which the iron core secondary may slide. An alternative method of varying the coupling would be to make both primary and secondary windings stationary and vary the position of the core or the reluctance of the magnetic circuit by movement of the swell pedal.

The filter circuit should be designed to eliminate any ripple voltage from the bias but the time constant should not be made too great or the response to movement of the swell pedal will be sluggish. Good results were obtained by making $C_1 = C_2 = 0.1\mu f$, $R_1 = 250,000$ and $R_2 = 500,000$ ohms.

It should be noted that this method of control is entirely free from sliding contacts and hence noise is completely and permanently eliminated. A second advantage is the possibility of locating the amplifier some distance away from the point of control. In this case only the variable coupling transformer need be in the console and the leads connecting it to the rectifier cannot introduce extraneous noise into the main amplifier circuit. Hence shielded wires do not have to be used nor their capacity reckoned with.

Below is shown a microphotograph of a human hair, the point of a small pin and the .0026" tubing, all magnified 180 diameters. A one-pound coil of this tubing is approximately eleven miles long.

To prove that this little "hair" is actually a tube it has been encased in a Lucite Quadrilon filled with oil. Nitrogen at 50 lbs. pressure is forced through the tube and forms a minute chain of bubbles rising to the surface . . . Exhibit is shown at left and magnified close-up below.

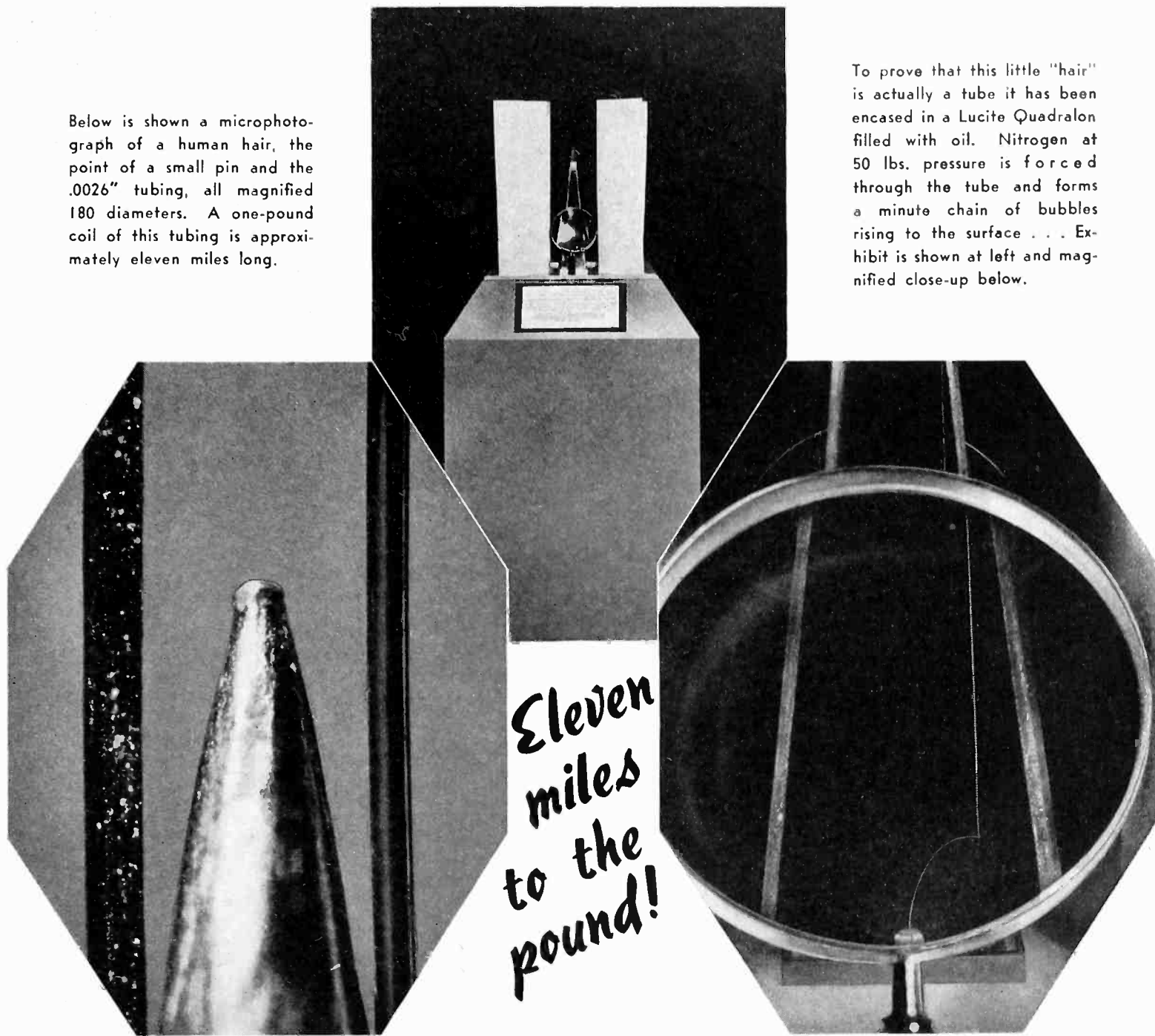

Eleven miles to the pound!

You designers and engineers who like to work way back of the decimal point would be interested in an astounding bit of craftsmanship on view at the World's Fair. Thousands visiting the West Virginia building have marveled, as they peered through powerful lenses, at an infinitesimal speck of pure nickel tubing exactly .0026" OD, with a wall thickness of only .0007 . . . As far as we know this is the smallest tube ever drawn and we doubt if it will find many practical applications. But it is ample evidence that the drawing of fine small tubing has been brought to an exact science here at Superior.

SUPERIOR TUBE COMPANY — NORRISTOWN, PENNA.

SUPERIOR TUBE PRODUCTS

SEAMLESS: Carbon Steels, Alloy Steels and Tool Steels, Stainless Steels, Aluminum, "Inconel", Nickel, "Monel". WELDRAWN: Carbon Steels and Stainless Steels. *BRAWN: "Monel" and "Inconel".

* Registered U. S. Trade-mark

SUPERIOR TUBING

New **UTC** VARITRAN CONTROLS

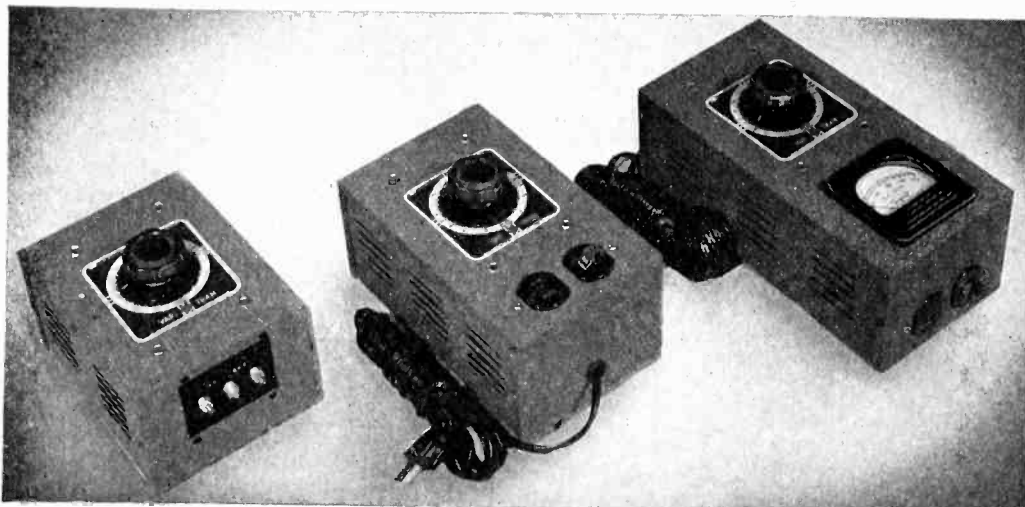

- ★ New roller contact . . . practically eliminates contact wear.
- ★ New glass insulated wire . . . for positive dependability.
- ★ New large, copper, heat radiating disc . . . for cooler operation.
- ★ New copper alloy collector ring . . . eliminates pigtails and loose connections.
- ★ Core type lamination . . . for maximum ruggedness and minimum space.
- ★ New top and bottom mounting . . . for panel, chassis, or bench service.

Type	Input Voltage	Output Voltage	Watts	Max. Amps.	Approx. Wt. Lbs.	Net Price
V-0	115 volts	0-130	230	2	8	\$7.50
V-0-B	230 volts	0-260	230	1	10	9.50
V-1	115 volts	0-130	570	5	11	10.00
V-1-M	115 volts	0-130	570	5	12	15.00
V-2	115 volts	0-130	570	5	11	9.00
V-2-B	230 volts	0-260	570	2.5	14	11.50
V-3	115 volts	0-130	850	7.5	14	14.00
V-3-B	230 volts	0-260	850	3.75	18	18.00
V-4	115 volts	0-130	1250	11	32	20.00
V-4-B	230 volts	0-260	1250	5.5	38	25.00
V-5	115 volts	0-130	1950	17	45	32.00
V-5-B	230 volts	0-260	1950	8.5	56	37.00
V-6	115 volts	0-130	3500	30	90	60.00
V-6-B	230 volts	0-260	3500	15	90	70.00
V-7	115 volts	0-130	5000	44	120	87.00
V-7-B	230 volts	0-260	5000	22	120	95.00

● **FOR CONTROLLING:** Line Voltage, Rectifier Output, Motors, Lights, Heaters, etc.

● Variable voltage transformers for smooth voltage control. VARITRAN units employ a special non-fusing roller contact to contact the exposed turns of an auto-transformer winding. Rugged construction is employed, with glass insulation to assure dependability. Output of 115 Volt unit variable from 0-130 volts (230 Volt unit; 0-260 V.) smoothly without interrupting circuit. Output voltage independent of load.

● Maximum Amp. rating applies from 0 to 20 and 95 to 130 volts. Between 20 and 95 volts current rating tapers off to 50% of rated current at 65 V. point.

● Top and bottom mounting for laboratory bench or panel mounting. All units supplied mounted, with terminal strips as in Fig. A except V-1 (Fig. B) and V-1M (Fig. C).

UNIVERSAL VARITRANS

These VARITRANS have a 115/230 V. primary winding and a smoothly variable secondary from 0-28 volts. Line voltage control can be effected for 102/140 V. or 197/243 volts to 115 V. or 220 volts respectively. The 28 volt secondary can also be used for low voltage lights, cauteries, trains, rectifiers, etc. The primary and secondary windings can be arranged to effect variable 220/115 or 115/220 volt arrangements. Appearance as in Fig. A above.

Type	Max. Amps. Output	Approx. Dimensions	Approx. Weight, Lbs.	Net Price
VL-0	1.5	3 3/4 x 4 1/4 x 3 3/4	5	\$5.50
VL-1	3.5	4 3/8 x 6 x 4 3/8	7	6.50
VL-2	6	4 3/8 x 6 x 5 1/2	10	8.00
VL-3	11	4 3/8 x 6 x 6 3/4	15	13.00

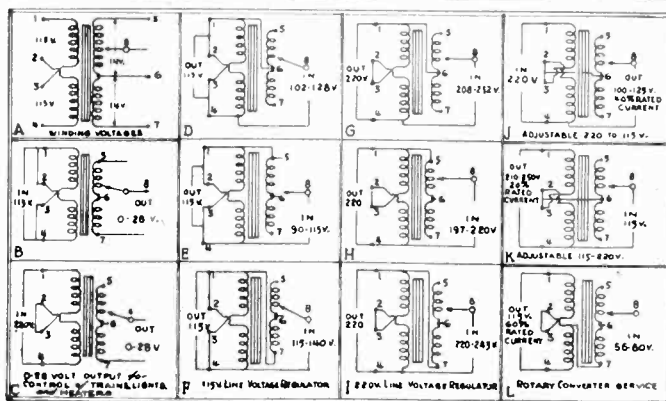

UNITED TRANSFORMER CORP.

Write: ENGINEERING DIV. ★ 150 VARICK ST. ★ NEW YORK, N. Y.
 EXPORT DIVISION: 100 VARICK STREET NEW YORK, N. Y. CABLES: "ARLAB"

In some applications it is desirable to be able to control the gain of a number of independent amplifiers by a single volume control. This may be readily done by supplying this variable a-c voltage or the rectified but unfiltered voltage to the amplifiers in question. Each amplifier will contain its own bias filter circuit unless circumstances make it more economical to have but one main filter and use shielded wire to connect the amplifier to the master gain control.

Finally, it will be seen that this method of control tends to stabilize the gain of the amplifiers to which it is connected against changes due to line voltage variation. If the line voltage falls tending to reduce the overall amplification the bias voltage will also fall due to the decreased primary voltage, and thereby tend to hold the gain up.

Improved Phototube Register Control

BY THE USE of the single source of light and a rotating optical projection system, Westinghouse engineers have succeeded in producing a highly accurate register control and have applied it to a lithographic press of the Redson-Rice Corp. in Chicago. This press is used for two-color lithographing of envelopes and letterheads, and it is necessary to control the position of the paper so that the two colors will be in proper relationship. The paper passes through the lithographing press on a roller of black material. Consequently at the edge of the paper there is a sharp distinction between the white of the paper and the black roller surface. On this dividing line, the newly developed light source is focussed.

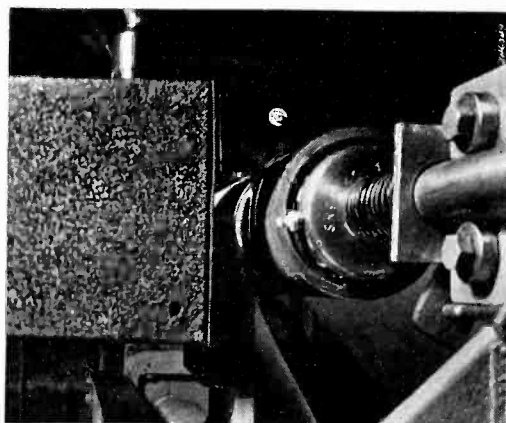

Light reflected from the roller controls the register

The light source consists of a single lamp whose light is projected on to the roller through four equally spaced lenses, which are mounted around the edge of a disk. This disk is driven by a motor. Consequently the light passing through the four lenses is distributed in a circular form, shown in

A FEW APPLICATIONS OF
S. S. WHITE FLEXIBLE SHAFTS

Power Drives

Instruments

Counters
Indicators
Speedometers
Tachometers
Taximeters

General

Air Conditioners
Aircraft Fuel Pumps
Bottling Equipment
Business Machines
Concrete Surfacers
Concrete Vibrators
Cotton Pickers
Engraving Machines
Flame Cutting Machines
Food Handling Machines
Hair Clippers
Home Workshops
Kitchen Appliances
Massage Machines
Mechanical Toys
Portable Tools
Screw and Nut Setters
Shoe Machinery
Tube Cleaners
Valve Grinders
Washing Machines
Windshield Wipers

Remote Controls

Automotive

Antenna Control
Carburetor Choke and
Needle Valve Adjustment
Clock Setting
Crank Case Drain
Engine Governor Control
Gear Shift Control
Radio Receivers
Retractable Head Lights
Trip Mileage Reset

Aircraft

Antenna Reel Control
Beacon Receivers
Compass Loop Control
Gyro Pilot Control
Heating Register Control
Radio Receivers
Tab Control
Variable Pitch Propeller

General

Cam Position Indicator
Centralized Machine Con-
trols and Adjustments
Electrical Switches
Gun Fire Controls
Oven Thermostat Controls
on Domestic Ranges
Valve Position Indicator
Washstand Drain Control
Weighing Balance Ac-
curate Adjustment



It pays
to use
**FLEXIBLE
SHAFTS**

That list of applications at the left may suggest possible uses of flexible shafts in equipment you are designing or may design in the future.

The point to remember is this: when you have to *transmit power*, or when you have to provide *mechanical remote control*, the inherently simple, reliable, economical way to do it is with a flexible shaft.

And because S. S. WHITE flexible shafts in each class, come in a wide range of sizes and physical characteristics, you can count on getting a shaft that is just right for your particular requirements.

Printed matter that will bring you up-to-date information on both types of shafts, is yours for the asking. Write for it—today.

S. S. WHITE

The S. S. White Dental Mfg. Co.
INDUSTRIAL DIVISION

Department E, 10 East 40th St., New York, N. Y.

When you want to measure

INDICATING INSTRUMENTS

PORTABLE

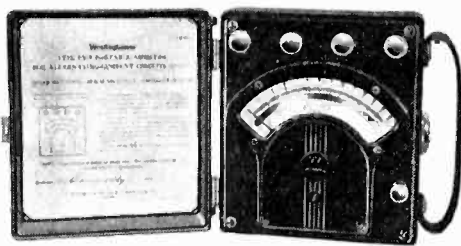
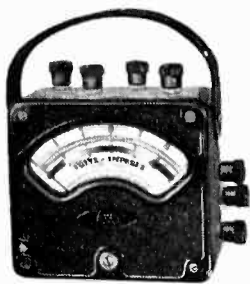

PX-4 ammeters, volt-ammeters and voltmeters, d-c, accuracy within $\frac{3}{4}\%$. PY-4 ammeters and voltmeters, d-c, accuracy within $\frac{1}{2}\%$. PY-5 ammeters, volt-ammeters, voltmeters and watt-

eters, a-c. Accuracy within $\frac{1}{2}\%$. The P-4 size is a general purpose test instrument, and the P-5 is a similar instrument for high-accuracy measurements.

PORTABLE CURRENT AND VOLTAGE TRANSFORMERS

Current transformers — 5 to 1000 amps, primary. Voltage transformers—230 to 6900 volts, primary. The accuracy of these transformers makes them satisfactory for all portable or laboratory applications.

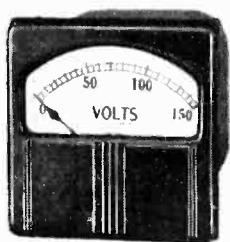
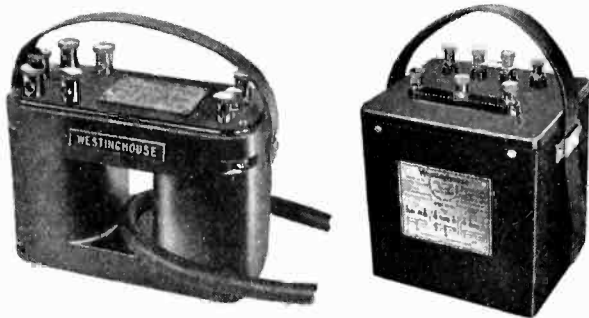

SWITCHBOARD

"H" line — $5\frac{1}{2}$ inch square cases, scale length, 5 inches; "K" line — $4 \times 4\frac{1}{4}$ inch cases, scale length, $3\frac{1}{2}$ inches. Compact steel cases for projection or flush-mounting — easily read, illuminated dials. Accuracy within 1%. For all switchboard applications.

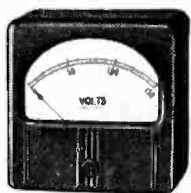
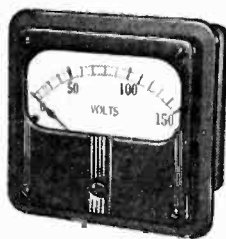

MINIATURE

Type 35, 3-inch class — and Type 37, 4-inch class. Compact instruments that require little space on small panels. Available in all types of cases

for a wide range of applications. Flush or projection mounting. Accuracy within 2%.

WHEN it is necessary to measure any electrical value — volts, amperes, watts, watt-hours or power factor — here are the proper Westinghouse Instruments for the job.

For experimental work, testing, planning or actual operation, these instruments are reliable, accurate and economical. You can depend upon their readings.

A simplified line, illustrated on these pages, covers all ordinary uses. Special-

NEW DEVELOPMENT

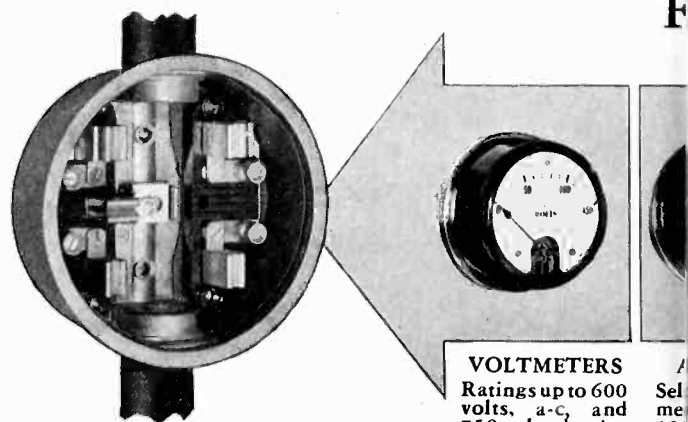

VOLTMETERS
Ratings up to 600 volts, a-c, and 750 volts, d-c. Accuracy within 1%.

Install convenient Westinghouse Sockets on any circuit or machine. Required instrument quickly attached, without wiring changes. A rapid, easy way to secure accurate operating data. Complete line of socket instruments available for measuring or recording all electrical values.

Westinghouse

ELECTRICAL VALUES

ized instruments take care of unusual applications. All must conform to Westinghouse standards of accuracy, precision and long life.

Ask any Westinghouse office for further information and prices. Send for your copy of Booklet 2219 — it contains valuable information on the Westinghouse system of electrical analysis. Address Westinghouse Electric, East Pittsburgh, Pa. Dept. 7-N.

POCKET INSTRUMENTS

Economical Analysis

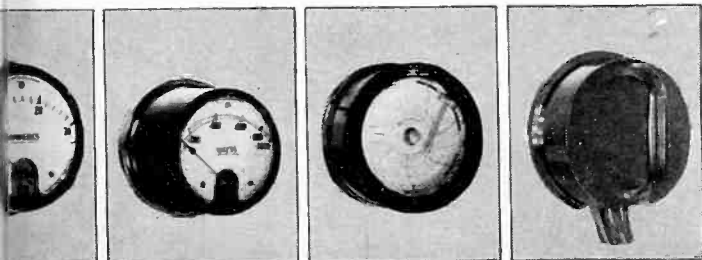

VOLTMETERS
Maintained —
as up to
1000 volts. Ac-
curacy within
1%.

WATTMETERS
Single-phase or
polyphase, 115
volts—5, 10, and
20 amps capacity.
Accuracy within
1%.

RECORDERS
Circular chart
voltmeters up to
750 volts and
ammeters to 125-
ampere capacity
—1, 3, or 7-day
chart. Accuracy
within 3%.

TEST JACK
Convenient
means of con-
necting any con-
ventional instru-
ment for test pur-
poses.



INDUSTRIAL ANALYZERS

Applicable with test jack. Give complete test data without a single wiring change. Save time and expense.

RECORDING INSTRUMENTS

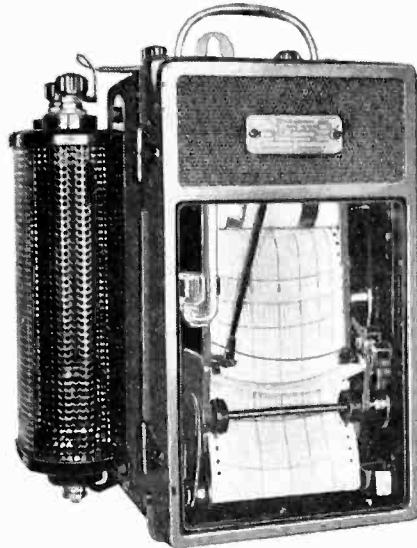

TYPE U

Voltmeters and ammeters, both portable and switchboard. Easy to install and operate, light in weight. Records continuous 8-day operation. Minimum friction. Accuracy within 3%. Permits assembling of data which otherwise would not be available without considerable expense.

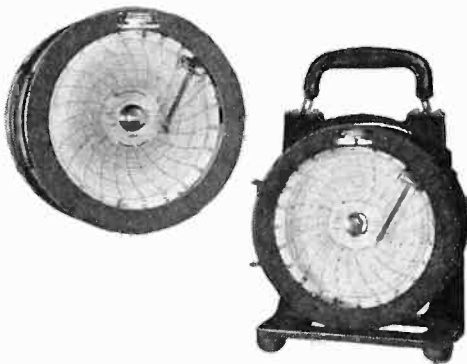

TYPE A

Circular chart voltmeters and ammeters, switchboard or portable. For measuring load curves, station curves and for a wide range of industrial applications. Accuracy within 3%.

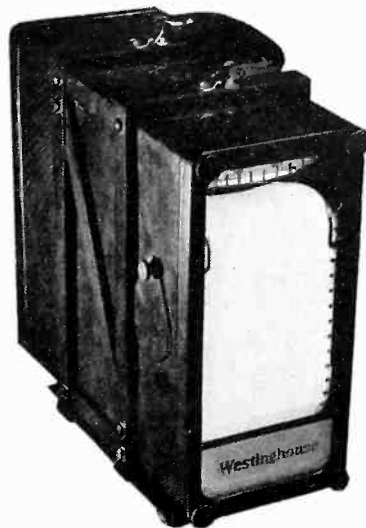

TYPE G-40

Direct-acting, strip-chart voltmeters, ammeters, wattmeters, and varmeters for 35, 17, 8, or 3-day records. Chart speeds — $\frac{3}{4}$, $1\frac{1}{2}$, 3 and 6 inches per minute or inches per hour. Accuracy within 1%.

J-40230

Instruments



500 WATTS CARRIER ON 33.1 MEGACYCLES

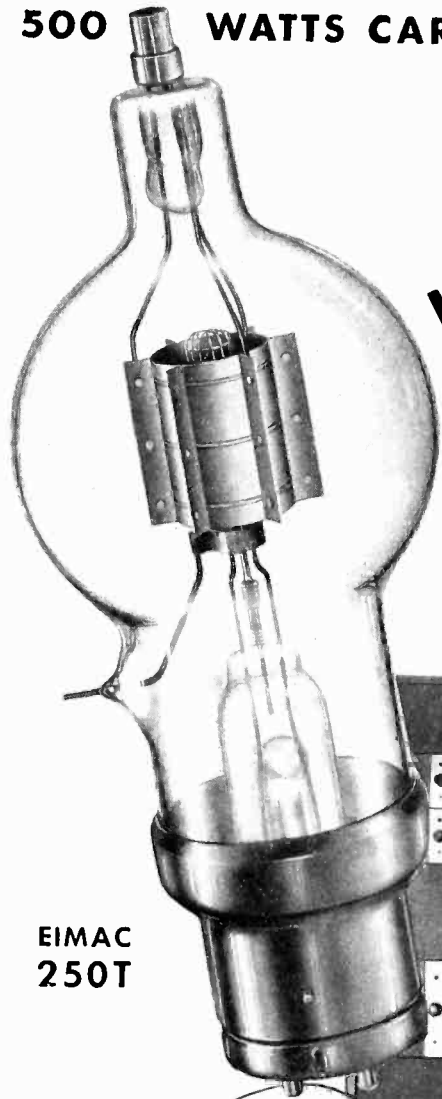

**EIMAC
250T**

**Kansas City Police
demand the finest
... and GET IT !**

*Where Long Life,
Dependability and
Superior Performance
are a Requisite ...
You'll Find Eimac Tubes*

*Police Radio Station "KQBH" Kansas City, Kansas
Built by Fred M. Link, Consulting Radio Engineer.
See this transmitter on display at the APCO National Convention.*

When the Kansas City, Kansas Police Department decided to install a new radio transmitter they selected Fred M. Link—Consulting Radio Engineer to build it. When Fred M. Link got the job he selected Eimac tubes for the important sockets. Result! Kansas City Police are assured of dependable communications.

With a pair of Eimac 250TH's in the final, modulated by another pair of 250TH's, this transmitter gives a 500 watt carrier on 33.1 megacycles.

The ever increasing list of important commercial radio transmitters that are using Eimac tubes should bring home to you the fact that Eimac tubes really offer decided advantages. Here is one important point that you should remember: Eimac tubes are constructed

of the finest materials available and although these tubes cost more than the average to produce their ability to outperform most others enables you to make economies that more than offset the original cost. For Example: An Eimac 250T tube at \$24.50 will do the work of other tubes costing \$85. And another thing—"Eimac tubes are unconditionally guaranteed against tube failures which are caused by gas released internally"—no other tube carries such a guarantee.

**Eimac
TUBES**

EITEL-McCULLOUGH, INC.
788 San Mateo Street, San Bruno, Calif.

the accompanying photograph, in such a way that one-half the circle rests on the paper and the other half on the black surface of the roller. When the distribution of light between the two surfaces is equal, the phototube which views the light assumes a balanced condition. However, if the paper tends to move one way or the other, the amount of light falling on it relative to that falling on the roller decreases or increases. This change in light, interpreted by a phototube, is transferred to a relay circuit which in turn actuates a motor. This motor is geared to the roller and operates to correct the displacement of the paper. The use of a single source of light and the rotating optical system has resulted in an exceedingly accurate and rapid-acting correction system. When the paper travels at the normal speed of 5.4 feet per second an off-register correction of $\frac{3}{32}$ inch can be compensated in one tenth of a second. Smaller displacements are corrected in proportionately smaller time. As a result of this installation the lithographic operations have reduced by 75 per cent the waste of paper due to imperfect color register.

...

Demonstration of Baird Large-Screen Television

DEMONSTRATIONS of the projection television equipment developed by the Baird Television Corporation in England have been conducted in New York City with the cooperation of the Gaumont-British Film firm. The picture size is 12x9 feet, although a picture 20x15 feet can be readily reproduced by the same equipment. The equipment has been modified to receive the

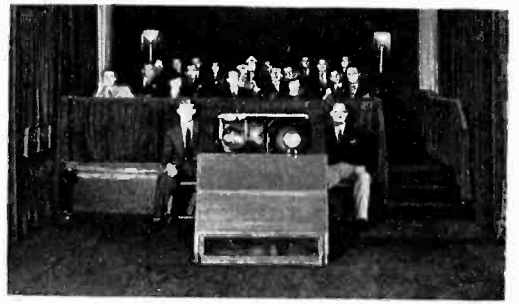

Television projector unit. Because of the high cost, one lens is used for the main and spare projectors

American (R.M.A.) standard transmissions. The demonstration is by far the most impressive of any projection television seen by the editors in this country. The screen brightness is less than that of a movie of the same size (a rough estimate is that the screen brightness is about one-quarter that of the usual motion picture projection) but it is still perfectly adequate for the purpose. The detail of the images left

Another C-D Development



TYPE UP

Etched Foil
DRY ELECTROLYTIC CAPACITORS

THE advance engineering design of these new type UP Etched Foil Dry Electrolytics is the result of many years of intensive research in the C-D laboratories.

This research has made possible:—

- ★ Minimum capacity change over wide temperature range.
- ★ Great reduction in physical size—up to 40% for some types.
- ★ Increased life expectancy.
- ★ Reduced direct current leakage.
- ★ Reduced equivalent series resistance.
- ★ Higher breakdown voltage.
- ★ Improved audio and radio frequency impedance characteristics.

The type UP is the smallest can type capacitor available, and can be supplied in single, dual, triple and quadruple capacity combinations. Complete physical and dimensional data will be supplied on request.

PRODUCT OF THE WORLD'S OLDEST AND LARGEST MANUFACTURER OF CAPACITORS

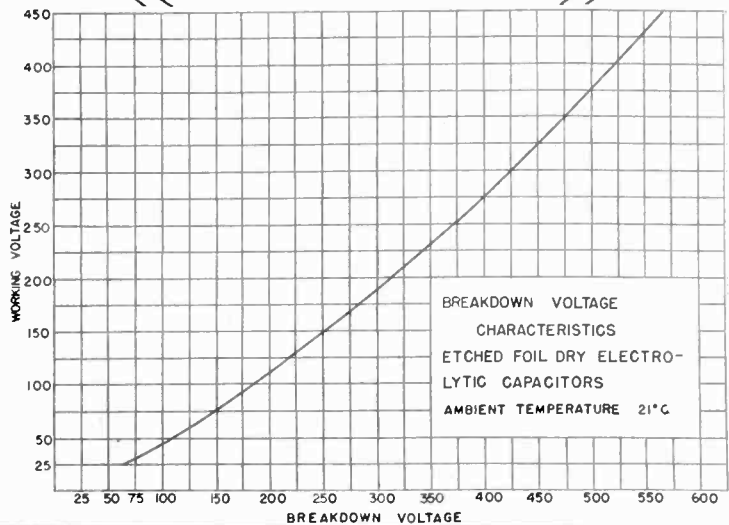
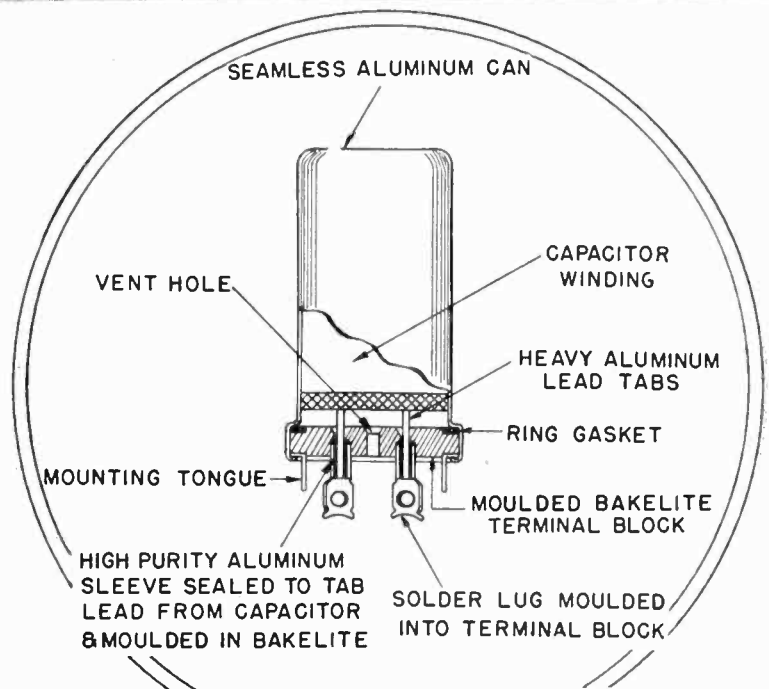

CORNELL-DUBILIER ELECTRIC CORPORATION

1006 Hamilton Boulevard, South Plainfield, New Jersey

Cable Address: "CORDU"

Assurance of Value



Select Richardson as your source of supply for all laminated and molded plastics. Enjoy the extensive manufacturing facilities, as well as the services of highly specialized technicians in engineering, design and research laboratories, of this complete organization. Whatever your requirements, consult Richardson. An interview will be advantageous.

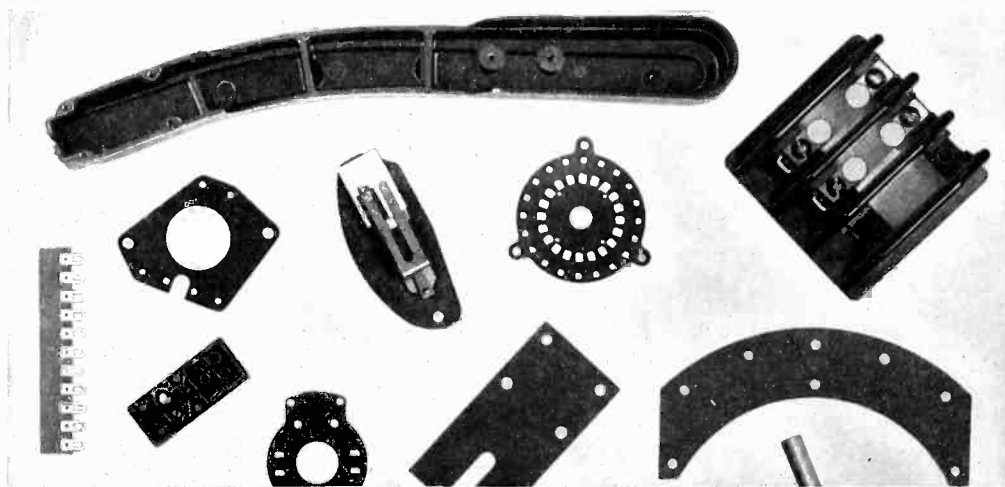

INSUROK

the Precision Plastic

The RICHARDSON COMPANY

MELROSE PARK, (CHICAGO) ILL. FOUNDED 1858 LOCKLAND, (CINCINNATI) OHIO
NEW BRUNSWICK, N. J. INDIANAPOLIS, IND.
DETROIT OFFICE: 4-252 G. M. BUILDING, PHONE MADISON 9386
NEW YORK OFFICE: 75 WEST STREET, PHONE WHITEHALL 4-4487

little to be desired. The lines of the image could be discerned on close inspection, and the detail along each line indicated that at least 250-line detail and probably closer to the 350-line detail was actually being reproduced. The only defect in the picture noticeable, comparable with performance of ordinary cathode ray television images, was the fact that the retrace lines were faintly visible throughout the performance. This was no doubt the result of the attempt to obtain the maximum brilliance in the reproduction.

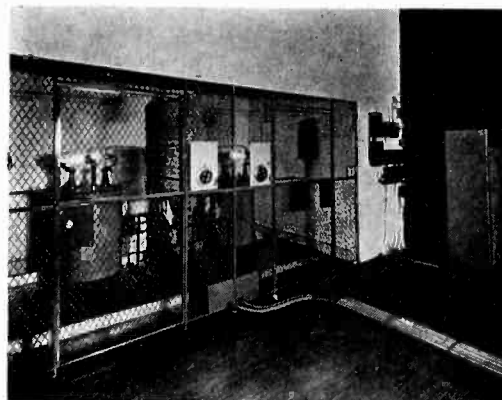

Power supply for the television projector

The projection tubes are two in number, one being used as a spare. The tubes have a somewhat spherical shape with a flat fluorescent screen presented to the lens system. The tubes are magnetically focussed and magnetically deflected. The power supply for the tubes, shown in the accompanying picture, develops 50,000 to 55,000 volts and is capable of 10 ma output. Actually between 300 and 400 microamperes are consumed by the tubes in an operation. The control electrode of the projection tube requires a peak-to-peak video signal of about 300 volts. The life of the tube under ordinary operating conditions is between 75 and 200 hours.

The lens system used to project the image from the fluorescent screen on to the viewing screen is of special design, and is by far the most costly item in the equipment. Its stop opening is between $f/1.5$ and $f/2$ and the diameter of the lens is about 7 inches. The lens system is somewhat restricted inasmuch as it offers but one position relative to the projection tube at which the lens will produce a focussed image. This is of no particular consequence since the position of the projecting equipment is ordinarily fixed in the theatre and the viewing screen does not change its position relative to the rest of the system. In the particular installation shown, the distance of the projection machine to the screen is about 28 feet. Because of the great expense of the lens system, only one lens is provided in the projection equipment. All the other equipment is provided in duplicate, including the receiver, power supply and projection tube. The lens is mounted so that it can be shifted from one tube to the other in a very short

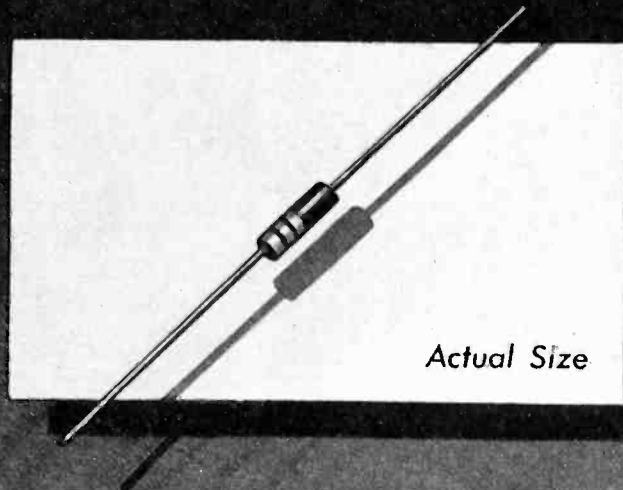

**MILLIONS OF THIS "NEW" IRC RESISTOR
SOLD DURING THE PAST YEAR**

...without Public Announcement!

The tremendous response accorded the new IRC 1/4-watt Insulated Type BT Resistor, merely upon submission of engineering samples to a comparatively few large concerns, indicates again the widespread acceptance of the IRC Metallized resistance principle among critical users. During its first year this little unit established a sales record probably never before equalled in the resistance field.

The IRC Type BT-1/4 is only 1/8" by 3/8" in size, thus making it adaptable and economical for a wide range of modern engineering requirements. It incorporates all of the exclusive construction features and excellent characteristics of the larger 1/2-, 1- and 2-watt Insulated Metallized Resistors. Now, with still further expansion of already elaborate production facilities, we are taking this means of announcing its general availability for original equipment.

INTERNATIONAL RESISTANCE COMPANY
403 N. Broad Street, Philadelphia, Pa.



RESISTORS

ALL FIXED and VARIABLE TYPES

ALSIMAG

Thirty-seven years of ceramic leadership backed by the best of materials, equipment, and personnel enables us to give you the finest in ceramics at prices you can afford to pay.

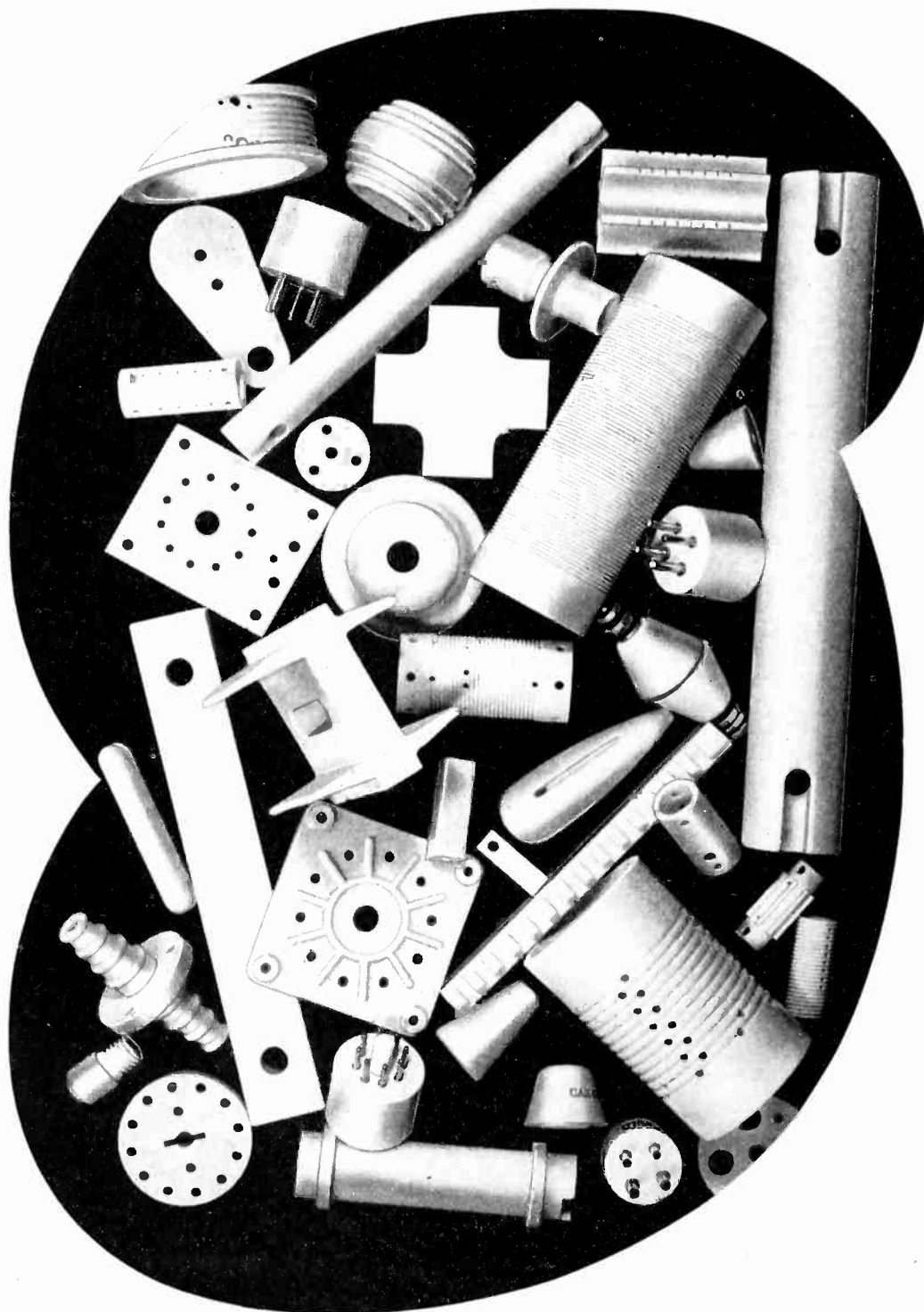

AMERICAN LAVA CORPORATION

CHATTANOOGA, TENNESSEE

BRANCH OFFICES

BOSTON
ST. LOUIS
WASHINGTON

CHICAGO
NEW YORK
PHILADELPHIA

CLEVELAND
LOS ANGELES
SAN FRANCISCO

time. In the event of failure, therefore, it is a matter of a few seconds to shift from one set of circuits to the other. The equipment is substantially the same as that used by several British theatres for showing television programs to the public.

• • •

Photoelectric Effects on Neon Tubes

BY ARTHUR K. BAKER

IN ANY CIRCUIT using small neon glow lamps (such as the GE types G-10, S-14, T-4½ and probably others) under conditions where the breakdown voltage is of importance, it is often necessary to consider certain photoelectric effects observable in many of the bulbs commercially obtainable.

The author first observed the effect of light on neon bulbs in a simple audio oscillator used as a nerve stimulator at Harvard Medical School. This oscillator consisted basically of a condenser charging through a high resistance and discharging through a neon bulb. When the cover of the box containing the apparatus was raised, thus exposing the glow lamp to the light, the frequency of the oscillations was increased, more or less proportionally to the amount of light falling on the glow lamp.

Later this phenomena was made the subject of a brief laboratory study, with some quantitative data taken. Voltage across the glow lamps was varied by means of a slide wire, and a meter in series with the neon bulb indicated the point at which breakdown occurred. One neon bulb was measured which broke down at 70 volts when kept in the dark, while in moderate daylight this bulb would begin to glow at about 62 volts, while if a 1000 watt arc light were brought within a foot of the bulb the breakdown voltage became about 55 volts.

It was further shown that if the voltage across the glow lamp was held just below breakdown, for the maximum amount of light encountered in a particular application, that the neon bulbs all exhibited photoelectric properties equal to those of a not-too-sensitive phototube.

In general it was necessary to use an extra stage with moderate gain to get comparable voltage amplification from the associated amplifier, as compared to the amplification necessary from a good gas photo-cell.

The experiments show however that whenever neon bulbs are used in voltage regulators; in simple oscillators of the type first mentioned, or in many other similar applications where continuously uniform breakdown voltage is desirable, that it is necessary either to keep the level of illumination on the glow lamp constant, or better to coat the outside of the glow lamp with an opaque material.

- ★ Long, well illuminated scales
- ★ Quick pointer response
- ★ Ruggedness



WESTON

Model 622

Ultra-Sensitive

Instruments

(Double pivoted type)

Model 622 series includes extremely sensitive instruments for laboratory use, as well as instruments for general testing. Available in single or multi ranges as:

MILLIVOLTMETERS

1 millivolt full scale, and up

MICROAMMETERS

5 microamperes full scale, and up

MILLIAMMETERS

AMMETERS

VOLTMETERS

(DC or Thermo)

in ranges to meet general requirements

The wide preference for WESTON Model 622 ultra-sensitive instruments for the measurement of minute currents is not alone for their rated sensitivity and accuracy. It is due, also, to WESTON'S conviction that these factors must be usable... practical... in service. » » The scales of these shielded instruments, for example, are normally 6.1" long, with large openings for maximum illumination... to insure quick, certain reading... *safeguard against reading errors*. Pointer response is fast... to conserve testing time. Double pivots eliminate the need for troublesome leveling... provide the ruggedness and dependability which is typically WESTON. » » Other features which increase that preference are... convenient switching arrangements on the multi-range types, simplicity of connections, quick replacement of couples in the thermo types. Why not have complete details on the Model 622 series? Catalog gladly sent on request. Weston Electrical Instrument Corporation, 618 Frelinghuysen Ave., Newark, New Jersey.

WESTON *Instruments*

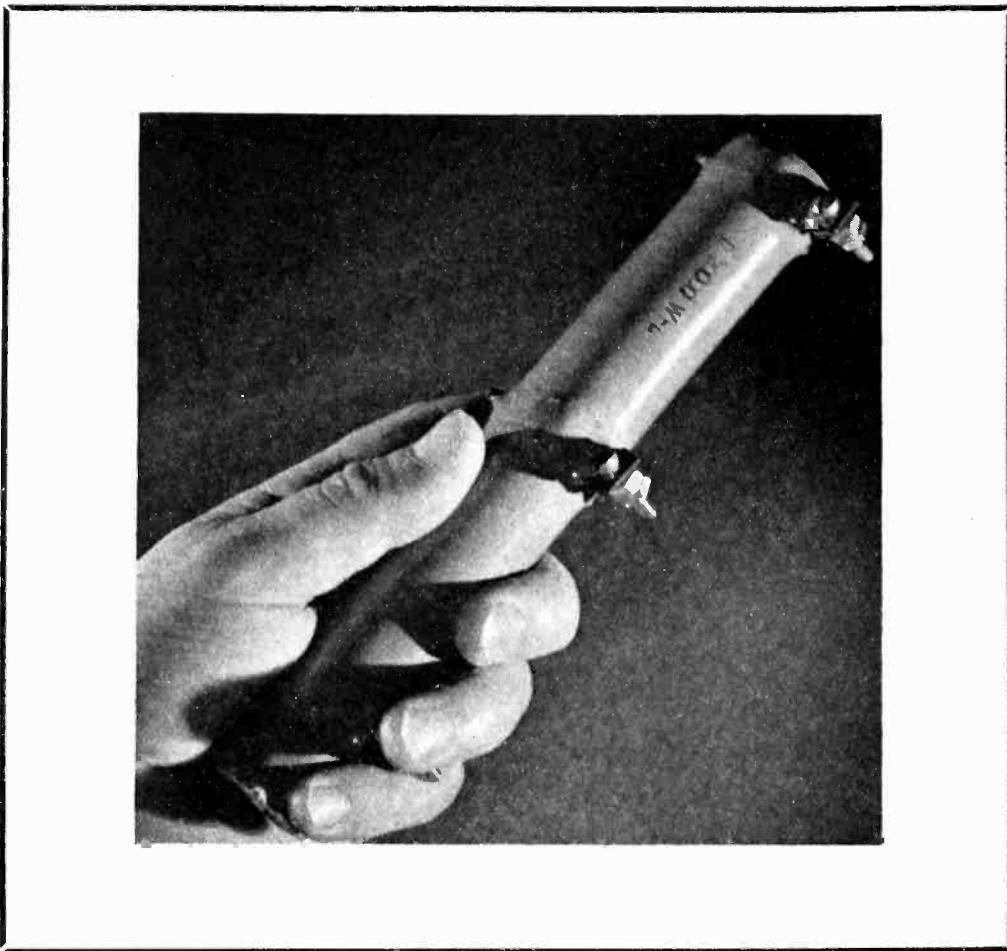

Phototube Inspects Oil Holes

A PHOTOELECTRIC shackle bolt inspection machine has recently been devised by Ralph Powers. The function of the machine is to inspect one shackle bolt per second to see that the oil hole is drilled through the upper part of the

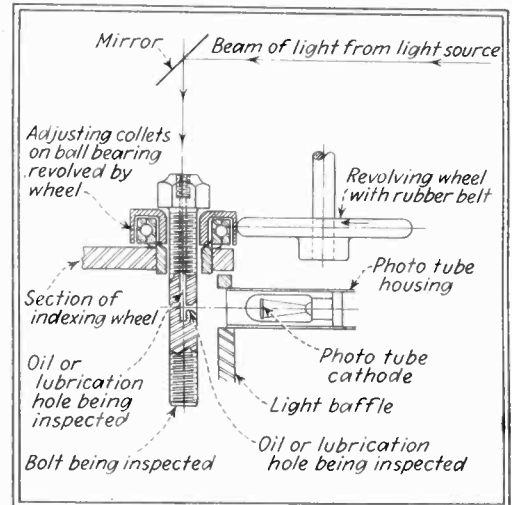

Light beam goes through oil hole and is reflected out of side hole to photo tube

SOMETHING NEW IN RESISTORS



The Ward Leonard line is complete including all sizes, ratings, terminals and mountings.

NEW VITROHM, the enamel now used in the manufacture of all Ward Leonard Resistors, has a *crazeless structure* that has been tested and proven to more than meet the requirements to withstand humidity, moisture, and immersion. Available in all sizes and types. Write for full information. Ask for Resistor Bulletin 11.

WARD LEONARD ELECTRIC COMPANY

Electric Control Devices Since 1892

Ward Leonard Electric Company, 32 South Street, Mount Vernon, N. Y.

Please send me Resistor Bulletin 11.

Name

Firm

Address

City and State

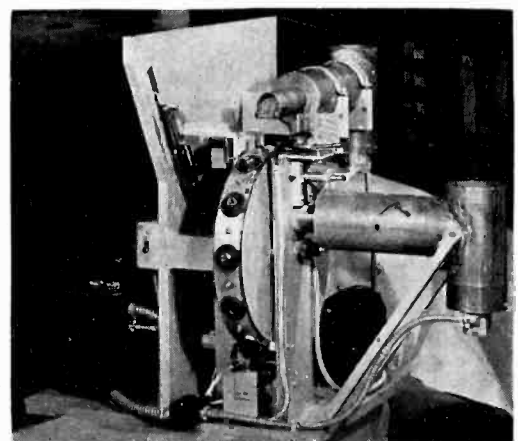

Drum is loaded by operator and is unloaded automatically

tion of the bolt allows the light to come out of the right angle hole and impinge upon the phototube. The phototube is mounted in the small tubular housing directly below the small upper motor support. The phototube amplifier on the back of the machine, through an arrangement of pins



PROPERTIES	SPEER GRAPHITE ANODES
1 WARP PROOF	✓
2 HEAT PROOF	✓
3 PUNCTURE PROOF	✓
4 GAS ABSORBING	✓

1. 2. 3. Overloading cannot damage SPEER Graphite Anodes. They cannot warp, fuse, blow out or soften.
4. SPEER Graphite Anodes tend to absorb gases given off by other tube elements—help keep tubes gas-free.

Why be Satisfied with Less?

SPEER Graphite Anodes have all these important properties. Why be satisfied with less? List of tubes with SPEER Graphite Anodes and Anode Booklet No. 70 mailed on request.



SPEER CARBON COMPANY

ST. MARYS, PA. CHICAGO CLEVELAND DETROIT MILWAUKEE NEW YORK PITTSBURGH



in Power Losses



DILECTO

On thicknesses 1/16" to 1/8" inclusive Dilecto XPLW has the remarkably Low Power Factor of .024 to .026 measured at 10^6 cycles per second—and it does not increase more than 10% after 48 hours' immersion in water at 68° F. Dielectric Strength, volts per mil, tests 450/650. Dielectric Constant, measured at 10^6 cycles per second is 5.0/5.5 This laminated plastic also possesses high mechanical strength, is half the weight of aluminum and machines like brass. It is chemically inert, insoluble and infusible. Add to these qualities a beautiful appearance and you have some idea of how DILECTO will fit into your plans for product development Your request for further information will receive a prompt and intelligent answer.

CONTINENTAL-DIAMOND FIBRE CO.
HEADQUARTERS FOR INSULATION RESEARCH NEWARK—DELAWARE



around the drum, stores an impulse with each inspected bolt that passes. If the pins are not pushed in, the bolt is clogged up and is dropped out at a bottom station. The large lower light source is for use in conjunction with bolts that have the oil hole drilled from the bottom instead of from the head. This photoelectric means of inspection is replacing the older methods of inspection used in conjunction with compressed air, as well as visual methods.

• • •

A Hiss-Silencer for Communication Receivers

THE EDITORS ARE indebted to Mr. Earl F. Whiddon, radio supervisor of the Division of Forestry, State of Massachusetts, for information on a hiss silencing circuit developed for use with

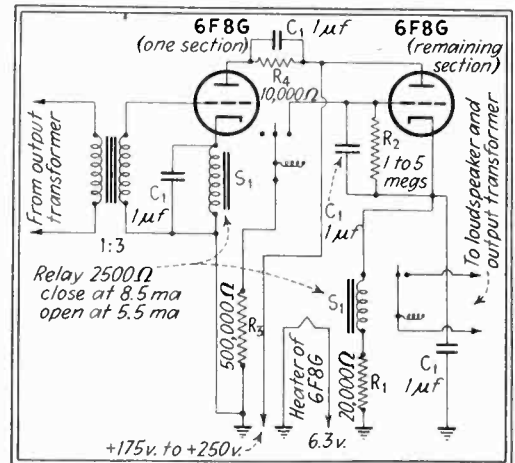

Circuit diagram of hiss-silencer

the communication receivers operated by the Forestry Division. In order to insure reliable communication with the various fire towers, it is essential that a super-regenerative first detector be used. The use of the super-regenerative detector entails an annoying hiss in the absence of the carrier signal.

Since the receivers are on for long periods, this noise becomes a distinct annoyance to the operating personnel. Accordingly a simple hiss-suppressing circuit was devised to silence the loud speaker in the absence of the carrier signal.

The circuit is shown in the accompanying figure. It consists of a simple 3-to-1 audio transformer coupled to the voice coil of the receiver and feeding the grid circuit of one section of the 6F8G double triode. In the cathode circuit of this section is a 2,500 ohm relay so adjusted that the relay remains open (contacts closed by spring pressure) so long as the hiss is absent (when the carrier is on). The presence of the hiss causes a sufficient increase in the plate current to close the relay. As the relay closes it opens the contacts in the grid circuit of the remaining 6F8G section (at the right of the diagram). This allows the grid of this section to assume cathode poten-

NEW 2-IN-1 PICK-UP

BY

Western Electric

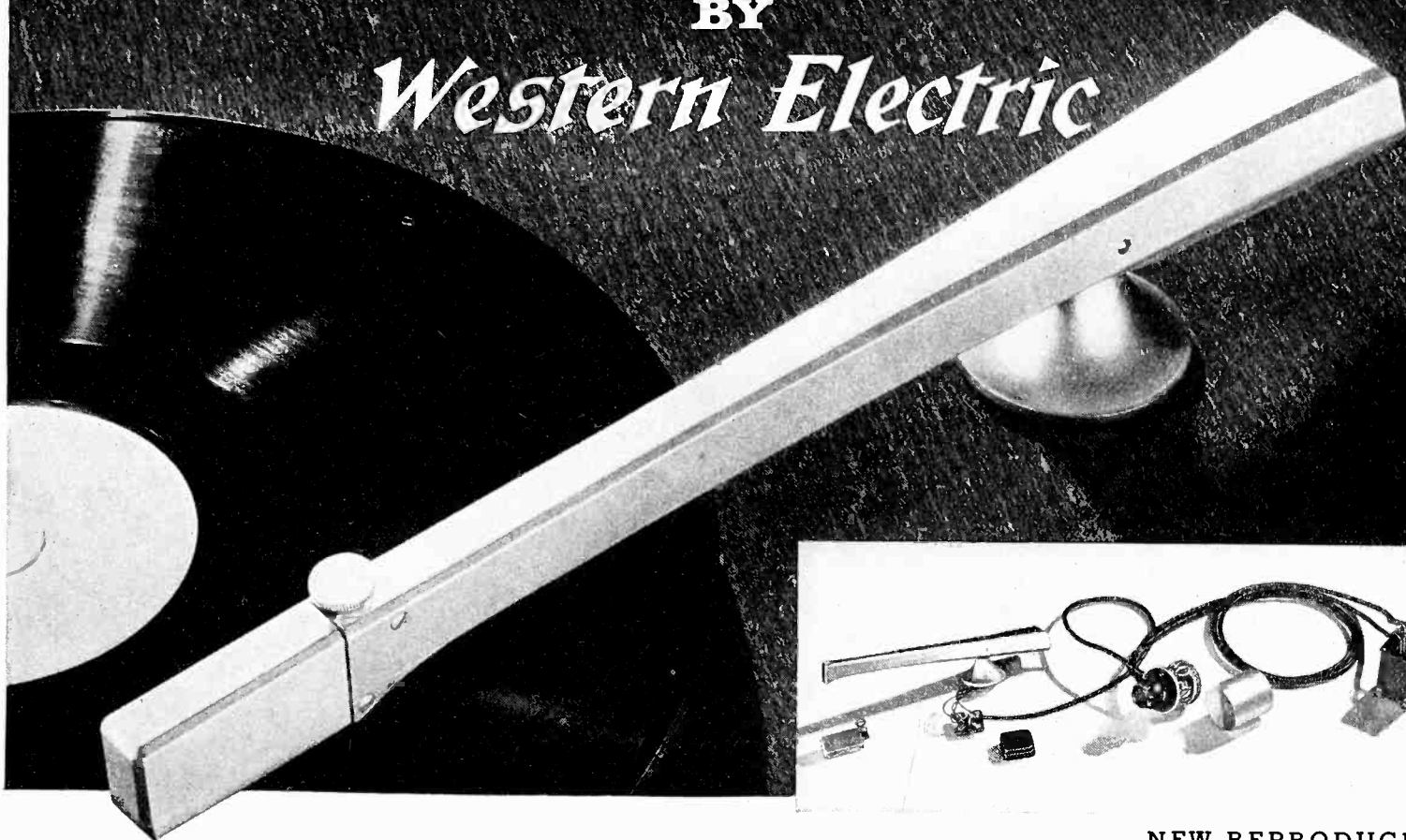

... plays both **VERTICAL** and **LATERAL** recordings!

Here's what you've wanted! A single pick-up that can handle any recording, vertical or lateral—that meets the most exacting requirements of transcription broadcasting. It reproduces faithfully the full quality of the recording—has a diamond stylus giving long record life—costs considerably less than the two pick-ups you'd ordinarily need to do its work.

With Western Electric's new Reproducing Group you can equip your present tables with equalized pick-up facilities matching the recording characteristics of the regularly available discs. A single con-

trol (selector switch illustrated) matches the pick-up circuit to the record and provides two "vertical" characteristics (one flat response to 10,000 cycles—one drooped above 8500 cycles) and five "lateral" characteristics (ranging from "straight through" to "sound effects"). Designed to work into your regular input circuits for broadcast microphones, it will match impedances of 30, 250, 500 or 600 ohms.

Get full details of this latest aid to Better Broadcasting—by Bell Telephone Laboratories and Western Electric. Ask Graybar for Bulletins T1630 and T1631.

ASK YOUR ENGINEER!



DISTRIBUTORS:

Graybar Electric Co., Graybar Building, New York. In Canada and Newfoundland: Northern Electric Co., Ltd. In other countries: International Standard Electric Corp.

NEW REPRODUCING GROUP

Contains reproducer and arm—with diamond stylus of practically unlimited life—equalizing equipment, switch, and necessary accessories.



NEW REPRODUCER SET

Western Electric 1300A—built around the 2-in-1 Reproducing Group. Two-speed flutterless turntable plays vertical or lateral recordings up to 16" in diameter. Operates on 110-120 volts, 60 cycle AC. Speech change entirely electrical. Not necessary to stop the table to change speed from 78 to 33 $\frac{1}{3}$ and vice versa.

OHMITE

Rheostats · Resistors · Tap Switches

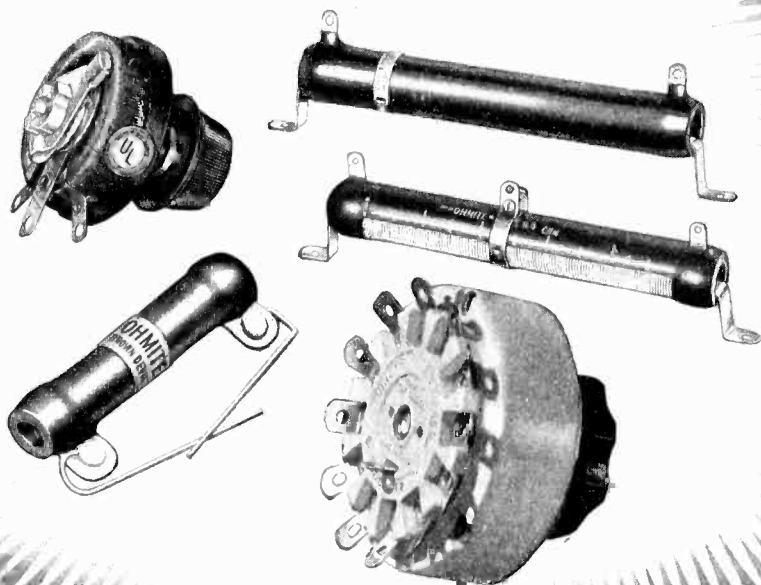

For Better Electronic Control



Design Engineers, Laboratory and Production Men long have found a plus value in the sound design and construction of Ohmite units which gives complete assurance of continuous, trouble-free performance in the most exacting applications.



OHMITE RHEOSTATS are unequalled for permanently smooth, gradual, close control. All-porcelain vitreous enamel construction—nothing to smoke, char, shrink or shift. Available in sizes from 25 to 1000 watts in many resistance values. OHMITE RESISTORS are accurately wire-wound and permanently protected by Ohmite Vitreous Enamel. Available in Fixed or Adjustable—Regular or Non-Inductive—General-Purpose or Precision Types. OHMITE NEW TAP SWITCHES bring new efficiency to high current circuit switching. All-enclosed ceramic construction, with silver-to-silver contacts and "slow-break," quick-make action. Available in four sizes from 10 to 75 amperes.

In the extensive range of Ohmite stock types, sizes and ratings, you can often find the quick, economical solution you seek—or let Ohmite Engineers, with their wide experience, cooperate with you in designing the best unit for your specific application. For Better Control—put your problem up to Ohmite.

Write today for your copy of Ohmite Catalog 17.

OHMITE MANUFACTURING COMPANY
4818 Flournoy Street ★ Chicago, Illinois, U.S.A.

Be Right with **OHMITE**
RHEOSTATS · RESISTORS · TAP SWITCHES

tial after a delay determined by the size of the $C_1 R_2$ combination between grid and cathode. As the plate current of this section rises the second relay pulls up and opens the loudspeaker circuit of the receiver.

When the hiss disappears (when the carrier comes on or for any other reason) the plate current in the left-hand 6F8G section reduces below the drop-out value of the relay and this closes the grid circuit of the right-hand section bringing the grid to ground potential. The plate current of the right-hand section immediately reduces to the drop-out value of its relay and the loudspeaker circuit is restored by the spring action of the relay armature. The circuit is thus arranged to allow a delay in removing the loudspeaker but no delay in returning it to the circuit. The delay introduced by the $R_2 C_1$ combination in the right-hand triode section is sufficient to prevent disconnection of the loudspeaker during modulation peaks.

The circuit employs simple components (one double triode tube two relays, four resistors, four capacitors and an audio transformer), hence its expense is small. Furthermore, the device occupies a very small space, and can readily be mounted in a 4x5x3 box, and also can be mounted inside the receiver case, and supplied with power from the receiver circuits. The unit has been tried on several forestry installations and has given complete satisfaction.



ELECTRICITY FROM HEAT



At the exhibit of Westinghouse Electric and Manufacturing Co. at the New York World's Fair spectators may see electricity produced directly from heat through the use of 190 thermocouples of chromel and alumel. Burning gas produces heat which the thermocouples convert into current which runs the motor to drive a small electric fan

INSULATING PARTS OF QUALITY AND UNIFORMITY

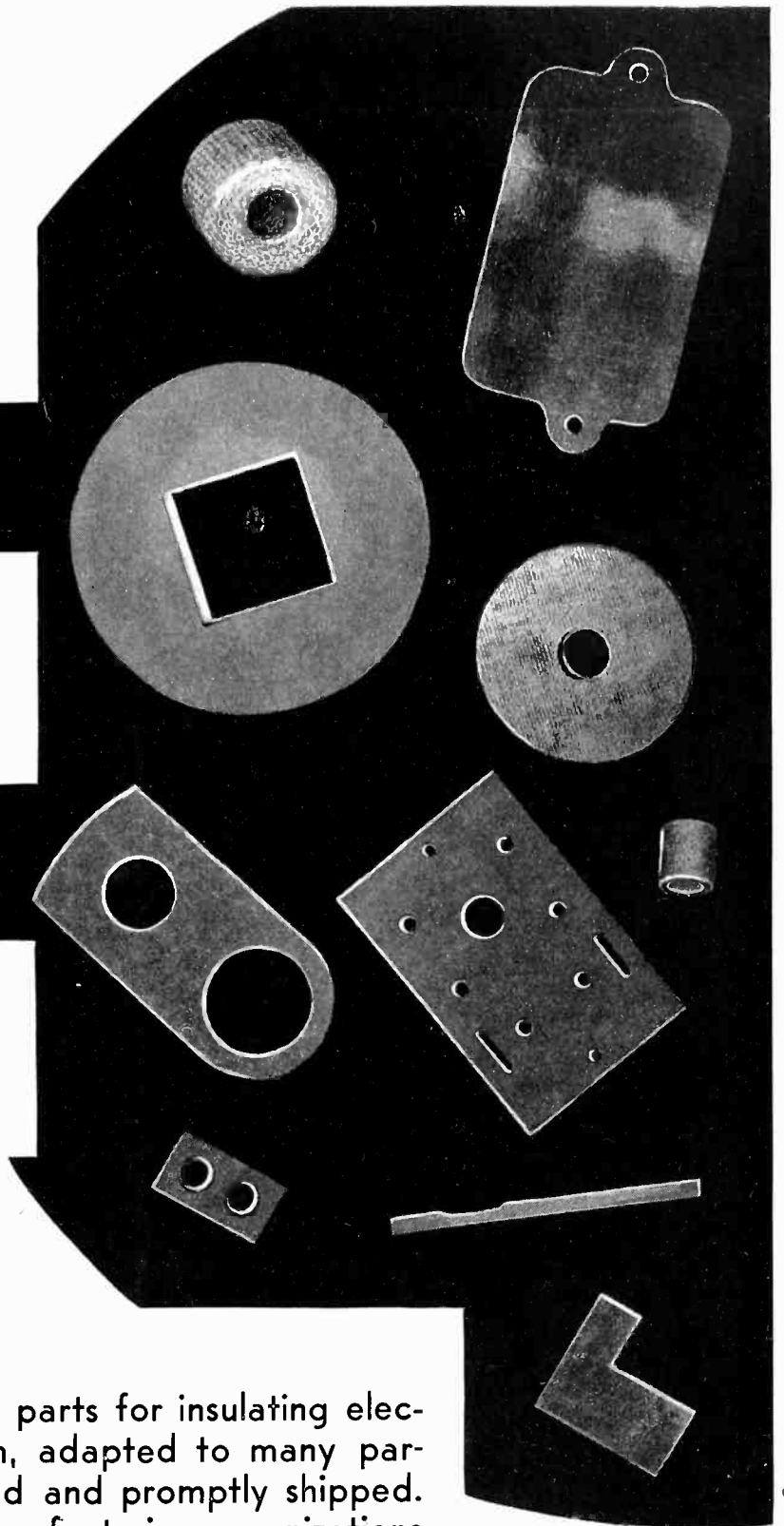

FORMICA produces phenolic laminated parts for insulating electrical devices of all kinds that are uniform, adapted to many particular requirements, accurately fabricated and promptly shipped. For that reason many leading electrical manufacturing organizations have used them over periods of many years, some as long as 25 years.

There is a grade to suit your requirements. Send us your blueprints for quotation the next time you are in the market for phenolic insulating sheet.

FORMICA

THE FORMICA INSULATION COMPANY

SPRING GROVE AVE., CINCINNATI, OHIO

THE ELECTRON ART

Each month the world's technical literature is scanned to see what physicists and engineers are doing with tubes, for presentation to *Electronics'* readers

Television Symposia

THE JULY ISSUES of both the *Journal of the Society of Motion Picture Engineers* and the *Journal of Applied Physics* are devoted almost exclusively to a discussion of the problems confronting the television industry. In both journals, each of the articles is prepared by a person well versed in the particular phase upon which he writes. It is, of course, impossible to give very detailed abstracts of the various articles, although a group of more than a dozen papers provides such a convenient reference material that there appears to be some advantage in compiling all of this data in one place.

The list of articles in the *Journal of Applied Physics* include: "Probable Influences of Television on Society," by David Sarnoff, "Survey of Television Pick-Up Devices," by Knox McIlwain, "High Definition Television," by Pierre Mertz, "Problems of Television Transmission," by Peter C. Goldmark, "Television Receiving and Reproducing Systems," by E. W. Engstrom and two related articles, "Electron Optics," by E. G. Ramberg and G. O. Morton, and, "Luminescent Materials," by Humboldt W. Leverenz and Frederick Seitz.

The article by Mr. McIlwain describes and compares the various television pick-up devices in use at the present time or recently developed. The theory of operation of the image dissector and the iconoscope are outlined and some estimates are given as to the sensitivity and resolution of both of the devices. A section of this paper is devoted to the useful or practical range of present commercial television pick-up devices and a table is given showing the brightness of outdoor scenes such as might be used in a television program. It is pointed out that neither the image dissector nor the iconoscope have been developed to the stage where it is ideal under all circumstances, but each has a definite field of usefulness as an element in satisfactory high definition television systems.

As a means of evaluating probable future developments, Mr. McIlwain presents a section on laboratory developments in which he discusses such matters as the two-sided mosaic, the barrier grid mosaic, the conductive mosaic and image amplifier.

In the article "High Definition Television," Pierre Mertz outlines in non-mathematical language three funda-

mental constructions underlying the analysis and synthesis of television images. Certain desirable and undesirable characteristics of the image are also enlarged upon and the system is compared with the method of half-tone reproduction in photo engraving.

A distinction is made between the definition possible with the early television system using from 30 to 50 scanning lines and modern systems using more than 400 lines in providing images of high definition.

After a general outline illustrating the various steps in the process of television transmission, Dr. Goldmark discusses certain specialized problems in transmitting television signals. The first of these is concerned with the transmission of the video signal through a cable, and it is pointed out that an equalized cable can be made to have substantially a flat frequency characteristic up to 8 Mc.

There are several types of modulation methods employed in television transmitters. One method, most universally adopted, is grid modulation of the power amplifier. Another method which is just in the process of being tried out, consists of modulating the carrier at a low level, at the same

time attenuating the lower side band with suitable filter. The third method, called, "transmission line modulation" impresses modulation across the transmission line between the power amplifier and the antenna. A block diagram of a typical grid modulated television transmission is given.

A considerable portion of the paper is devoted to a discussion of wave propagation problems. Some mention is made of the requirements for properly designed television transmitting antennas, and the propagation characteristics of the carrier frequency are discussed. The effect of delayed signal, resulting in multiple images is also treated. Finally, the author treats the problem of the number of stations and frequency assignments required to provide adequate coverage of a given geographical area.

The paper by E. W. Engstrom gives a general outline of the method of operation of television receivers and the electro-optical reproducing system by which the television image is recreated. The frequency spectrum required for a complete television system is outlined and current practices are discussed as to the type of emitted video and audio signals. It is shown that a superheterodyne circuit is well suited for meeting the receiver requirements and that by a proper adjustment of the tuned circuits of this receiver, the overall selectivity of the picture part of the receiver may be made such as to provide a flat overall video response characteristic. The use of automatic volume controls for both the sound and the video portions of the television signal are presented.

A section of the paper is devoted to the cathode-ray tube television reproduction system in which the image of the original scene is reconstructed on the luminous screen of the cathode ray tube. The requirements of a television reproducing system are outlined and the similarity between television and oscilloscope tubes are touched upon. Methods of deflecting the electron beam, as well as of modulating its intensity are discussed.

The article on "Electron Optics," provides a mathematical discussion of the literature on electron optics available at the present time. The paper by Leverenz and Seitz, on "Luminescent Material" provides a general survey of the present state of knowledge of luminescent materials and shows a large number of curves giving the relative energy as a function of wave lengths for a wide variety of luminescent materials suitable for use in the screen of cathode ray tubes.

Articles on television appearing in the July issue of the *Journal of the Society of Motion Picture Engineers* include: "Application of Motion Picture Film to Television," by E. W. Engstrom, G. L. Beers, and A. V. Bedford; "A Continuous Type Television Film Scanner," by P. C. Goldmark; "Television Studio Technic," by A. W. Protzman; "Television Lighting," by W. C. Eddy; "An Introduction to Tele-

CYCLOTRON READY FOR TEST

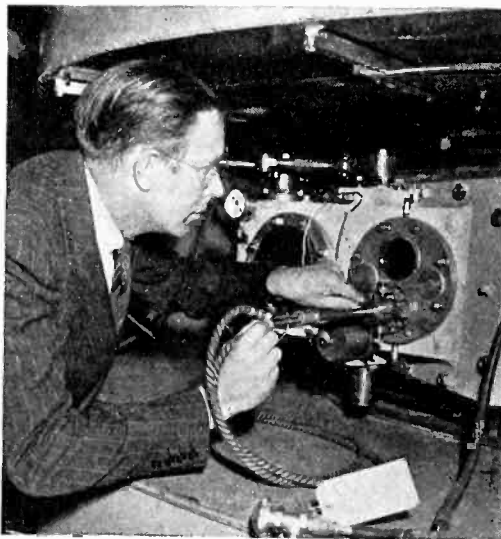

Dr. E. O. Lawrence, director of the radiation laboratory at the University of California, makes final checks on the 225 ton cyclotron designed for studying atomic structure

Erie CERAMICON

REG. U. S. PAT. OFF.

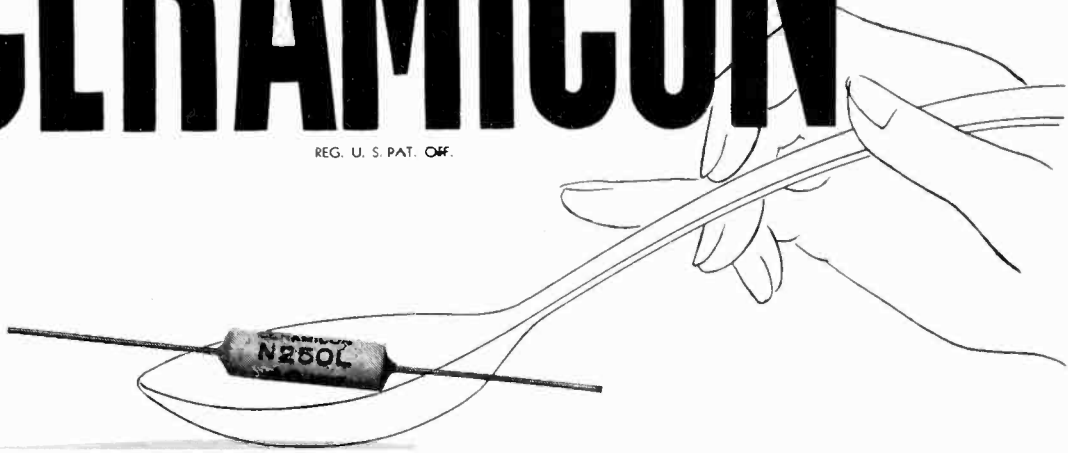

SUBSCRIPTION ORDER CARD

Enter my subscription for **ELECTRONICS** and send me bill:

One year for \$5.00 Three years for \$10.00

Name _____

Street and No. _____

City and State _____

Firm _____ Position _____

(Subscriptions quoted for U. S. and Possessions, Canada, Central and South America, \$1.00 additional per year for foreign)

Printed in U.S.A.

9-39

ACTIVE ANTIDOTE FREQUENCY DRIFT

In radio receivers, frequency drift due to temperature variations may be caused by changes in inter-terminal capacity in coil forms, tube sockets, and change switches etc., or by dimensional changes in coil forms and condenser stator mount-

There are two ways to eliminate this drift if it is of a known amount. You can use better components—a step that requires considerable engineering and increased costs in anywhere from three to five or more parts—or you can insert an Erie Ceramicon in the oscillator circuit as part or all of the capacitive reactance. The use of Erie Ceramicons does not involve any drastic change in either design or production set up and yet they will efficiently compensate for frequency drift due to temperature.

Erie Ceramicons are available with any definite, linear and reproducible temperature coefficient between +.00012 per °C. and -.00068 per °C. The full range of capacities of both insulated and non-insulated Erie Ceramicons is shown in the chart at the left.

Our engineering department will be glad to recommend specific units to fit your requirements.

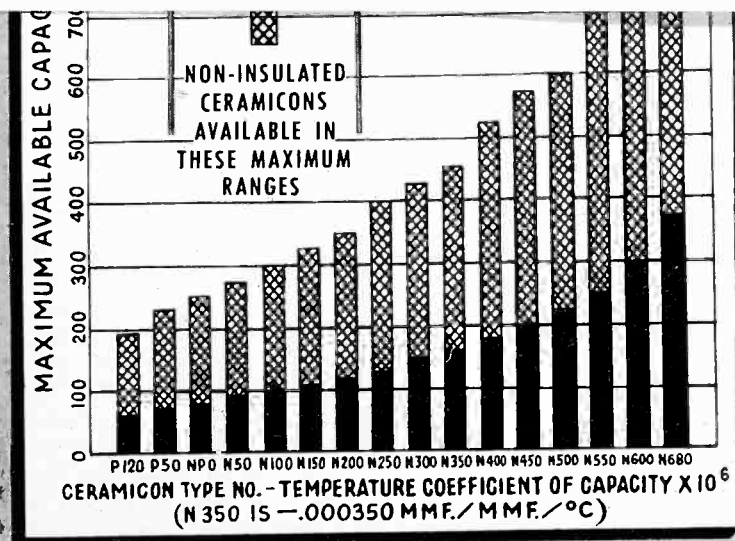

NEW WIDE RANGE IN SINGLE UNITS

ERIE RESISTOR CORPORATION, Erie, Pa.

TORONTO, CANADA • LONDON, ENGLAND • PARIS, FRANCE - J.E. CANETTI CO.

MANUFACTURERS OF RESISTORS • CONDENSERS • MOLDED PLASTICS

THE ELECTRON ART

Each month the world's technical literature is scanned to see what physicists and engineers are doing with tubes, for presentation to *Electronics*' readers

Television Symposia

THE JULY ISSUES of both the *Journal of the Society of Motion Picture Engineers* and the *Journal of Applied Physics* are devoted almost exclusively to a discussion of the problems confronting the television industry. In both journals, each of the articles is prepared by a person well versed in the particular phase upon which he writes. It is, of course, impossible to give very detailed abstracts of the various articles, although a group of more than a dozen papers provides such a convenient reference material that there appears to be some advantage in compiling all of this data in one place.

The list of articles in the *Journal of Applied Physics* include: "Probable Influences of Television on Society," by David Sarnoff, "Survey of Television Pick-Up Devices," by Knox McIlwain, "High Definition Television," by Pierre Mertz, "Problems of Television Transmission," by Peter C. Goldmark, "Television Receiving and Reproducing Systems," by E. W. Engstrom and two related articles, "Electron Optics," by E. G. Ramberg and G. O. Morton, and, "Luminescent Materials," by Humboldt W. Leverenz and Frederick Seitz.

The article by Mr. McIlwain describes and compares the various television pick-up devices in use at the present time or recently developed. The theory of operation of the image dissector and the iconoscope are outlined and some estimates are given as to the sensitivity and resolution of both of the devices. A section of this paper is devoted to the useful or practical range of present commercial television pick-up devices and a table is given showing the brightness of outdoor scenes such as might be used in a television program. It is pointed out that neither the image dissector nor the iconoscope have been developed to the stage where it is ideal under all circumstances, but each has a definite field of usefulness as an element in satisfactory high definition television systems.

As a means of evaluating probable future developments, Mr. McIlwain presents a section on laboratory developments in which he discusses such matters as the two-sided mosaic, the barrier grid mosaic, the conductive mosaic and image amplifier.

In the article "High Definition Television," Pierre Mertz outlines in non-mathematical language three funda-

mental constructions underlying the analysis and synthesis of television images. Certain desirable and undesirable characteristics of the image are also enlarged upon and the system is compared with the method of half-tone reproduction in photo engraving.

A distinction is made between the definition vision scanning using moving image.

After the various television discusses in transmission through a character

There relation transmission universally of the position which is tried out carrier a



BUSINESS REPLY CARD

First Class Permit No. 64 (Sec. 510, P. L. & R.) New York, N. Y.

ELECTRONICS

McGRAW-HILL PUBLISHING CO., Inc.

330 WEST 42nd STREET,

NEW YORK, N. Y.

CYCLOTRON READY FOR TEST

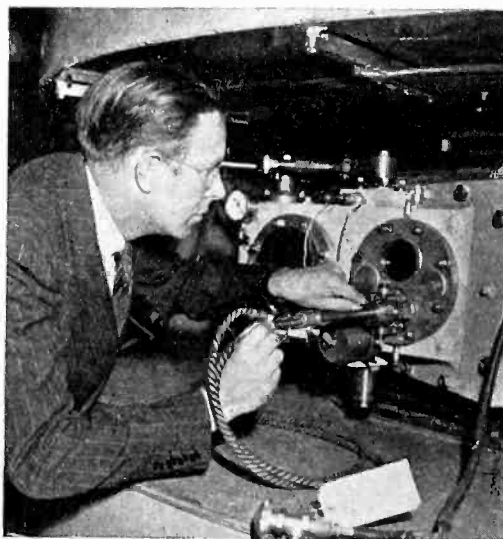

Dr. E. O. Lawrence, director of the radiation laboratory at the University of California, makes final checks on the 225 ton cyclotron designed for studying atomic structure

time attenuating the lower side band with suitable filter. The third method, called, "transmission line modulation" impresses modulation across the transmission line between the power amplifier and the antenna. A block diagram of a typical grid modulated television transmission is given.

A considerable portion of the paper is devoted to a discussion of wave propagation problems. Some mention is made of the requirements for properly designed television transmitting antennas, and the propagation characteristics of the carrier frequency are discussed. The effect of delayed signal, resulting in multiple images is also treated. Finally, the author treats the problem of the number of stations and frequency assignments required to provide adequate coverage of a given geographical area.

The paper by E. W. Engstrom gives

ray tube. The requirements of a television reproducing system are outlined and the similarity between television and oscilloscope tubes are touched upon. Methods of deflecting the electron beam, as well as of modulating its intensity are discussed.

The article on "Electron Optics," provides a mathematical discussion of the literature on electron optics available at the present time. The paper by Leverenz and Seitz, on "Luminescent Material" provides a general survey of the present state of knowledge of luminescent materials and shows a large number of curves giving the relative energy as a function of wave lengths for a wide variety of luminescent materials suitable for use in the screen of cathode ray tubes.

Articles on television appearing in the July issue of the *Journal of the Society of Motion Picture Engineers* include: "Application of Motion Picture Film to Television," by E. W. Engstrom, G. L. Beers, and A. V. Bedford; "A Continuous Type Television Film Scanner," by P. C. Goldmark; "Television Studio Technic," by A. W. Protzman; "Television Lighting," by W. C. Eddy; "An Introduction to Tele-

Erie CERAMICON

REG. U. S. PAT. OFF.

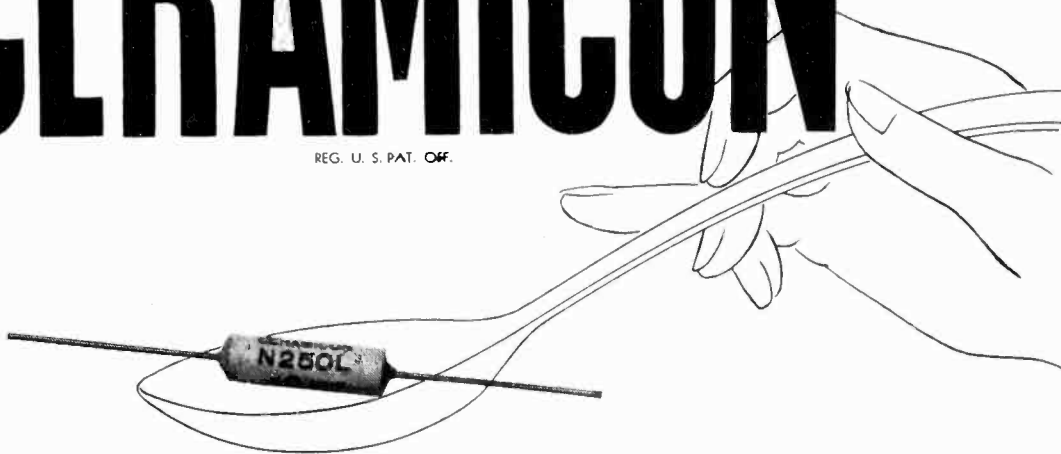

A SIMPLE, EFFECTIVE ANTIDOTE FOR UNDESIRABLE FREQUENCY DRIFT

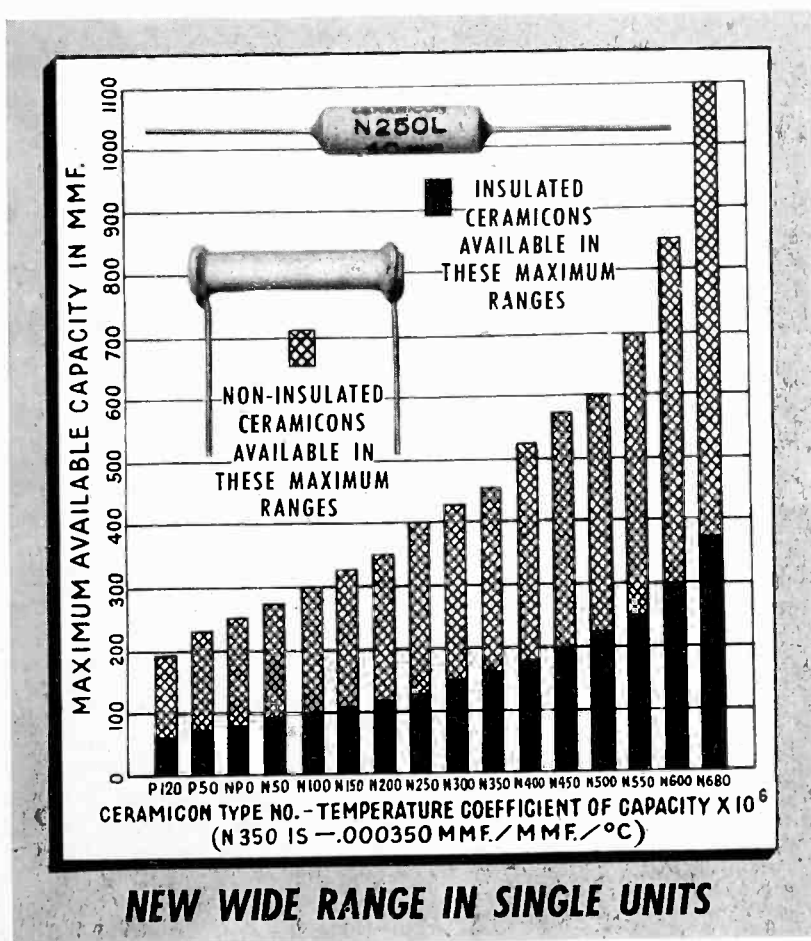

In radio receivers, frequency drift due to temperature variations may be caused by changes in inter-terminal capacity in coil forms, tube sockets, band change switches etc., or by dimensional changes in coil forms and condenser stator mountings. There are two ways to eliminate this drift when it is of a known amount. You can use better components—a step that requires considerable engineering and increased costs in anywhere from three to five or more parts—or you can insert an Erie Ceramicon in the oscillator circuit as part or all of the capacitive reactance. The use of Erie Ceramicons does not involve any drastic change in either design or production set up and yet they will efficiently compensate for frequency drift due to temperature.

Erie Ceramicons are available with any definite, linear and reproducible temperature coefficient between +.00012 per °C. and -.00068 per °C. The full range of capacities of both insulated and non-insulated Erie Ceramicons is shown in the chart at the left.

Our engineering department will be glad to recommend specific units to fit your requirements.

ERIE RESISTOR CORPORATION, Erie, Pa.

TORONTO, CANADA • LONDON, ENGLAND • PARIS, FRANCE - J.E. CANETTI CO.

MANUFACTURERS OF RESISTORS • CONDENSERS • MOLDED PLASTICS

LIGHTNING SCORES DIRECT HIT... BUT this protector did its job!

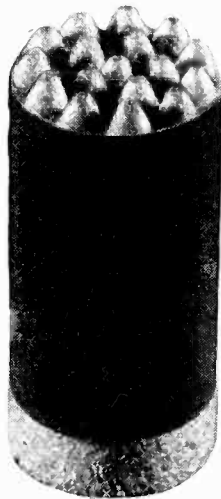
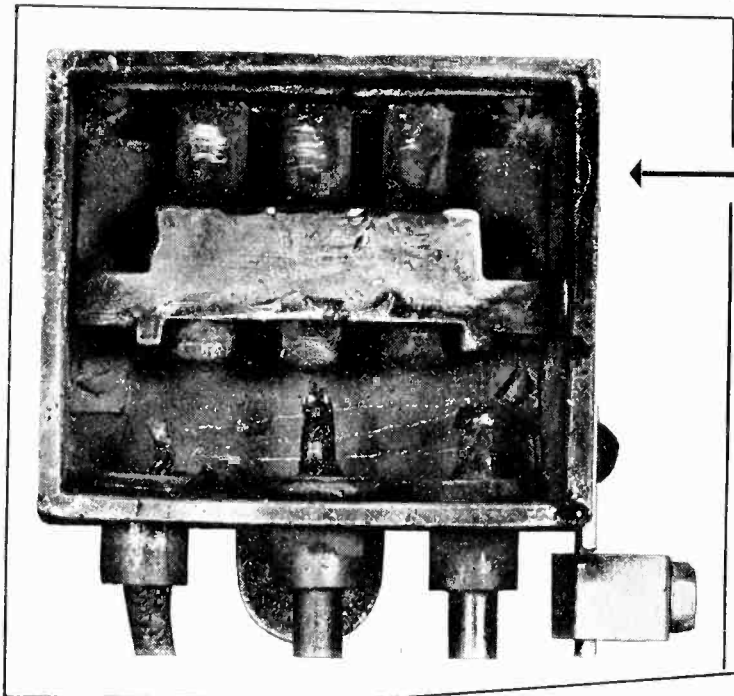

Globar Brand Type B Resistor with metallized ends, one end multi-pointed. Negative voltage characteristic. In the meter protector, three of these resistors are located below a non-arcing metal plate.

A direct lightning stroke destroyed this M & W 3-phase, 440-volt, Watt Hour Meter Protector... fused the metal parts, burnt out the lead-ins but the resistor elements came through unscathed...but in dissipating the stroke it protected valuable meters and potential coils 100%. Previous to installing this M & W Protector several meters were lost every season at this particular location because of lightning surges.

Globar solves resistor problem on new M & W Watt-Hour Meter Protector

Globar Brand Ceramic Resistors are an important part of the new watt-hour meter protector recently introduced by The M & W Electric Manufacturing Co., Inc. Working with the designers of this device, Globar engineers were able to produce a special resistor to meet the

many exacting requirements necessary for efficient, dependable operation. As the result of this cooperation, the manufacturer soon found his resistor problem was no problem at all! Perhaps you, too, can benefit from the same helpful Globar service. Let us know about your problem.

GLOBAR DIVISION

THE CARBORUNDUM COMPANY, NIAGARA FALLS, N. Y.

REG. U. S. PAT. OFF.

Sales Offices and Warehouses in New York, Chicago, Philadelphia, Detroit, Cleveland, Boston, Pittsburgh, Cincinnati, Grand Rapids

(Carborundum and Globar are registered trade-marks of The Carborundum Company)

vision Production," by H. R. Lubcke; "Design Problems in Television Systems and Receivers," by A. B. DuMont, as well as a Report of the Television Committee.

The article by Engstrom, Beers, and Bedford states that motion picture film will form an important source of programs for television broadcasting. Film projectors for this use are required to meet a number of conditions peculiar to television. Methods for projecting and utilizing motion picture film are outlined by the authors, and a specific film projector and associated television channel are described in some detail.

In establishing a technique for producing films most suitable for television, equipment is needed to interpret the final results. Apparatus that will be used by broadcasting stations is described. A simpler system has been designed that may be useful for the specialized service of gauging the merit of films for television. A description of this system as well as an outline of its operation is given. The authors include some observations on the characteristics of films that have given good results in experimental and field tests for television transmission.

The article by Dr. Goldmark describes a motion picture film scanner, the first of the continuous type to be used for television transmissions. The apparatus described has been in use since the middle of 1937, and in its preferred form, the scanner projects the image of a continuously moving film onto the cathode of a dissector tube. Five images, representing different portions of the film in the gate, produced by five stationary lenses, are

SPORTS MATCH TELEVISED



Philip Dorte, television producer, watching rehearsal of a sports match at Wembley Stadium, from mobile television van

Behind the scenes at CINAUDAGRAPH

. . . are men and machines to handle each step in the manufacture of these high quality speakers. From the polyfibrous cones wrought in the company's own pulp mill to heat treating and grinding of the magnets, it's part of Cinaudagraph's job. All coils and transformers used on Cinaudagraph speakers are wound here in the plant. Every component part, in fact, is engineered and assembled *on the premises*. Cinaudagraph exercises complete and rigid control every step of the way. This supervision is your assurance of a more dependable speaker.

Whatever your requirements, Cinaudagraph has a speaker unit to fill the need or can design one exactly to specification. Cinaudagraph engineers invite you to consult with them.

CINAUDAGRAPH CORPORATION

Stamford • Connecticut

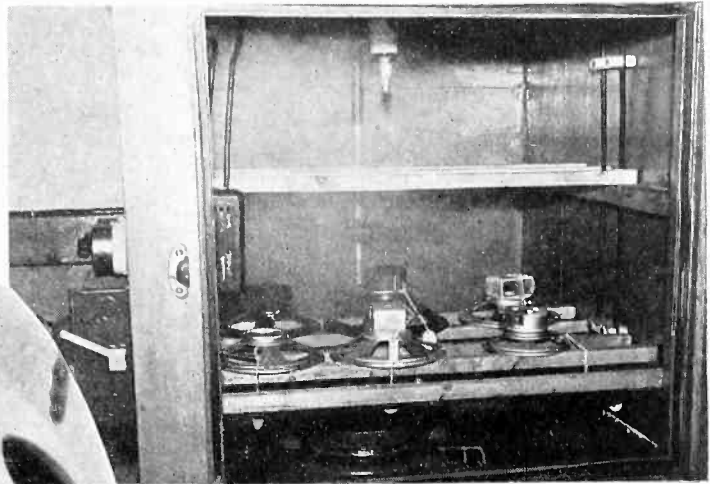

Cinaudagraph Speakers will operate under all climatic conditions. Production line models are spot checked, in a humidity chamber to prove their ability to operate under conditions for which they are designed. Atmosphere in chamber is kept at 98% relative humidity.

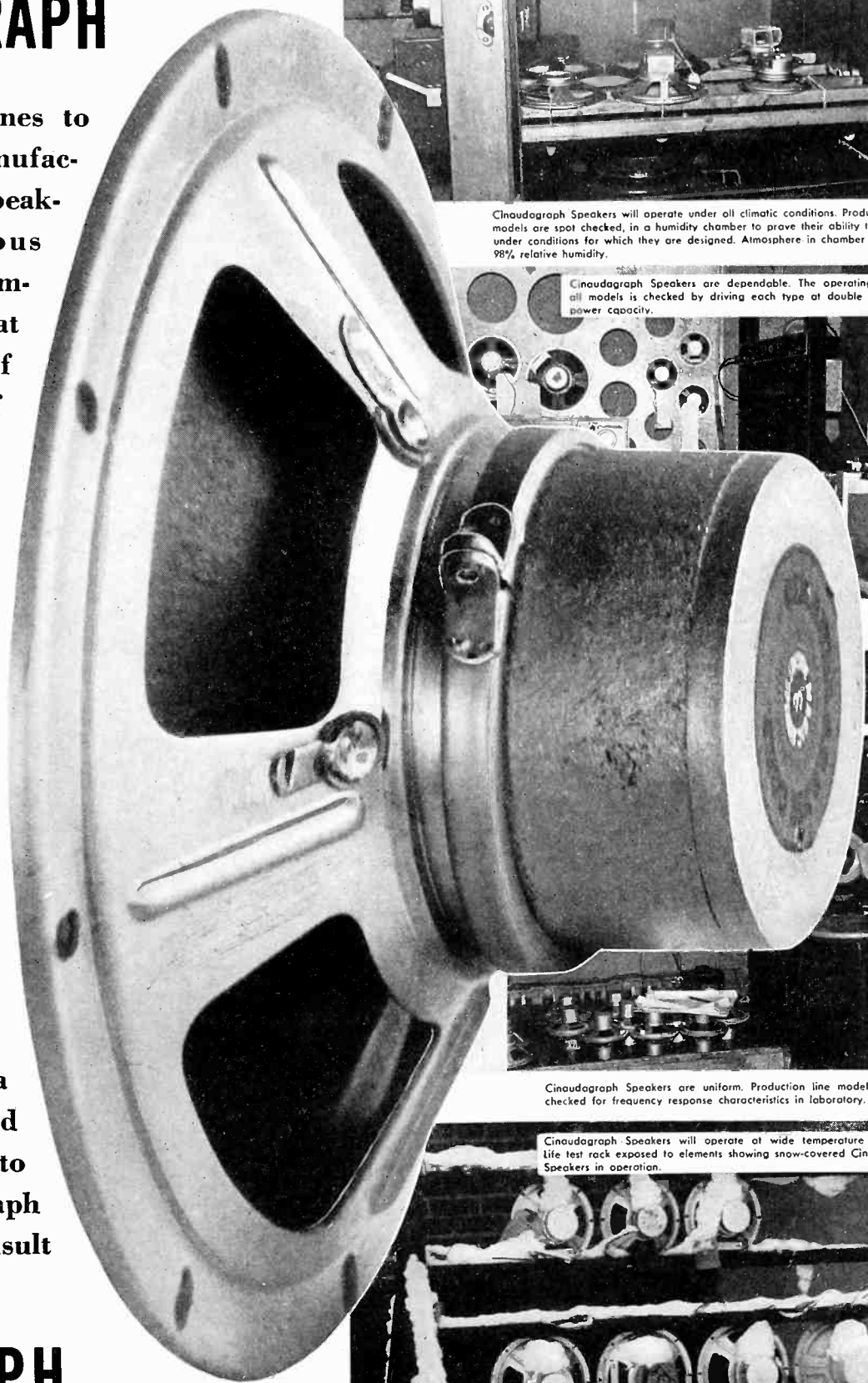

Cinaudagraph Speakers are dependable. The operating life of all models is checked by driving each type at double its rated power capacity.

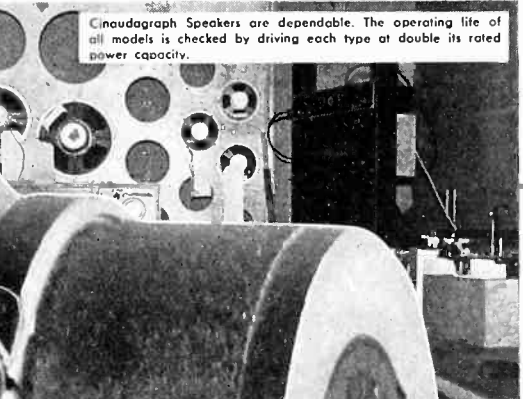

Cinaudagraph Speakers are uniform. Production line models are spot checked for frequency response characteristics in laboratory.

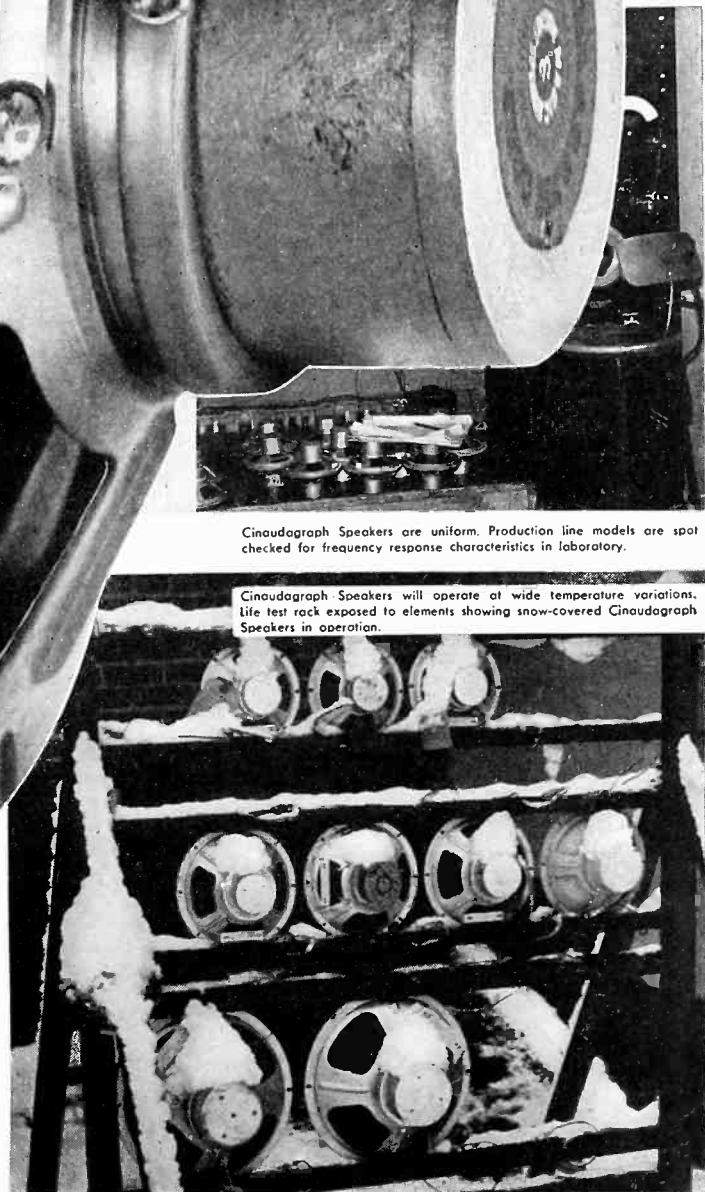

Cinaudagraph Speakers will operate at wide temperature variations. Life test rack exposed to elements showing snow-covered Cinaudagraph Speakers in operation.

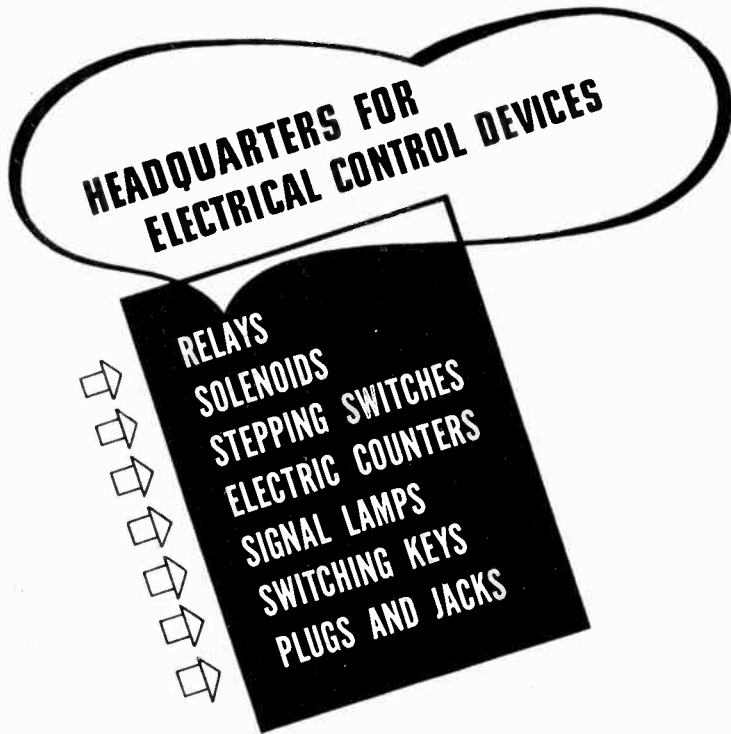

★ For 50 years, we have specialized in the manufacture and application of these devices. May we apply our experience to your problems? American Automatic Electric Sales Co., 1033 W. Van Buren St., Chicago.

AUTOMATIC ELECTRIC

MAKERS OF TELEPHONE AND SIGNALING APPARATUS
ELECTRICAL ENGINEERS, DESIGNERS & CONSULTANTS

GOAT'S HISTORY OF SIGNIFICANT EVENTS—6 IN '98 . . .

The populace of this country was stunned by the sinking of the Battleship Maine, which helped precipitate the Spanish American War. The Fred Goat Company, now 5 years old, was called upon to supply precision machine tools.

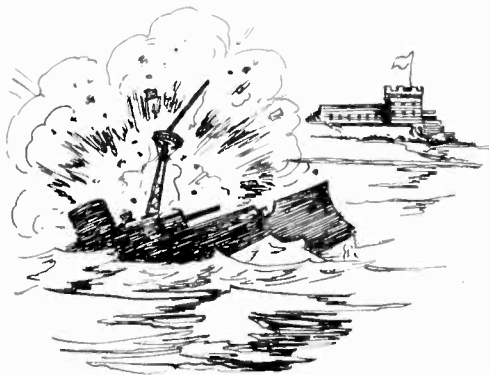

TODAY . . .

in 1939, the United States is a more powerful influence in world affairs than at any other time in its history. The use of Goat Radio Tube Shields has grown, too, so that today they are the most widely used radio tube shield in the world.



GOAT RADIO TUBE PARTS, Inc.

(A DIVISION OF THE FRED GOAT CO., EST. 1893)
314 DEAN STREET, BROOKLYN, N. Y.

superimposed, one on top of the other, while a rotating shutter with concentric slots permits only one lens at a time to produce an image. The scanning is accomplished partly by the uniform motion of the film, and partly by the magnetic scanning of the electron image in the opposite direction. The pictures thus obtained are completely free from shading, cover a great range of contrast, are free from flicker, and are steady. The construction of the scanner is simple and inexpensive.

In "Television Studio Technic" by Albert W. Protzman, the studio operating technique as practiced in the NBC television studios today is discussed and comparisons are made, where possible, to motion picture technique. Preliminary investigations conducted to derive a television operating technique revealed that both the theatre and the motion picture could contribute certain practices.

The problems of lighting, scenic design, background projection, and make-up are discussed with special emphasis on the difficulties and differences that make television studio practice unique.

An explanation is given of the functioning of a special circuit used in television sound pick-up to aid in the creation of the illusion of close-up and long-shot sound perspective without impracticable amount of microphone movement. The paper concludes with a typical television production routine showing the coordination and timing of personnel and equipment required in producing a television program.

The current television technical facilities of the Don Lee Broadcasting System in Los Angeles are briefly described by Harry R. Lubcke in an article, "An Introduction to Television Production." A mosaic type camera and accompanying control equipment

LONDON HIGH VOLTAGE LABORATORY

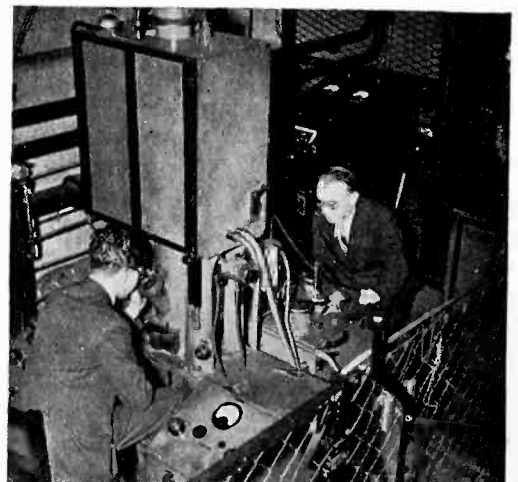

Students of the University of London operating cathode ray oscilloscope in the high voltage laboratory where "artificial lightning" is generated. The high voltages are used for research projects as well as for making tests on equipment for various manufacturers



"Facsimile

• THE NEXT MONEY-MAKER
FOR BROADCASTERS" © 1939 F. T. L., Inc.

- Investigate the potential earning power of Finch Facsimile—the system that prints news of the world in the home—while it happens!
- New equipment now available reproduces 2, 4 or 5-column newspaper format at speeds up to 20 square inches per minute. Press matter, drawings, photos and complete advertisements are reproduced full-size in fine detail.
- Finch Facsimile can be used with radio, landlines and suitable cable circuits with equal facility. Operates from any source of power and is completely self-synchronizing under all service conditions.

Radio engineers and executives are invited to inspect Finch Facsimile Station W2XBF in operation daily at 1819 Broadway.

FINCH
TELECOMMUNICATIONS, INC.
1819 BROADWAY, N. Y. CIRCLE 6-8080



The heart of the 280 tube

WILBUR B. DRIVER CO.
NEWARK, NEW JERSEY

are used. A coaxial cable conveys the signal from the camera to the television transmitter, operating on 45 and 49.75 Mc.

The routine of production of a dramatic comedy serial entitled "Vine Street," is utilized as an example for illustrating the method used in producing a television program. A total time of 20 hours of one or more members of the dramatic unit is required to prepare and present one fifteen-minute episode.

The sequence of production is as follows: preparation of strips; construction or modification of props and scenery; cast memorization of lines; cast rehearsals; camera, sound, sound-effects, light rehearsal with production staff; make-up; the performance itself, including visual-aural introduction of the act; the performance proper with overall supervision of lighting, microphone, and television adjustments by a television-producer at a distant receiver; closing announcement; written and verbal report of errors or advances in technique made during the performance.

Specifications for the physical instrumentalities and the current television technique are covered for each of the above factors of production.

A discussion is presented by Allen B. DuMont of the present-day television standards as adopted by the Radio Manufacturers Association, stressing their importance in relation to the design and production of television receiving equipment. This material is presented in Mr. DuMont's paper "Design Problems in Television Systems and Receivers."

Emphasis is placed upon the limitations of the standards and the possibility of their obsolescence in the future. It is claimed that the lack of flexibility embodied therein is very likely to cause serious difficulties for the industry in the future, for the transmission of a video signal is a much more complex problem than the transmission of an audio signal as in modern radio broadcasting where standards were relatively unimportant.

As an aid to circumventing many of the limitations of the present tentative standards, a new system of television transmission standards is proposed which will greatly simplify the considerations involved in the design of television receivers.

Beam Tetrode for Ultra-High Frequency

THE DESIGN of a vacuum tube capable of delivering 10 watts useful power output at frequencies of the order of 250 megacycles and with a d-c plate voltage of 400 volts, and with economy of space and cathode power is discussed by A. K. White in the July issue of the *RCA Review* under the title, "A Push-Pull Ultra High Frequency Beam Tetrode." In order to keep the physical dimensions of the tube small and make it adaptable to



"dag" and Corona

Corona discharges in and around high voltage apparatus are objectionable for many reasons, chief among which are radio interference and insulation breakdown.

The use of "dag" colloidal graphite can markedly limit these effects. This material forms tenacious and homogeneous films whose conductivity depends on the readily varied content of pure electric-furnace graphite.

A grounded coating of this material can, for example, be applied to the outside of the windings of high voltage apparatus to maintain uniform ground potentials and limit destructive leakage discharge currents.

A note describing your problems will bring technical advice. Ask for Bulletin No. 270.

The above should not be considered as recommending the use of colloidal graphite in violation of any valid patents which may exist.

Photographs courtesy GE

ACHESON
COLLOIDS CORP.

PORT HURON
MICHIGAN



Moving Coil Vibration Pick-Up

Type RA-278

The RA-278 Vibration Velocity Pick-Up is of special interest to the aircraft and automotive industries. It also has application to engineering and production testing problems in many other industries.

Being an inertia type pick-up operating on the moving coil principle, the RA-278 has the stability characteristic of Western Electric microphones in acoustic testing work. In addition, it gives you flexibility of application heretofore unknown in vibration testing.

1. Calibration stability—Independent of temperature, humidity or other conditions surrounding test.

2. Wide frequency range—Measurements of vibration down to 5 c. p. s. or below, possible in conjunction with suitable instruments.

3. Sensitivity—Far in excess of any re-

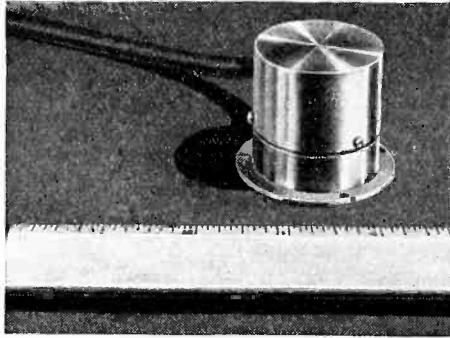

quirements encountered in automotive or aircraft work.

4. Light weight—Total weight less than four ounces, minimizing damping effect on surface under test.

5. Convenience—Can be used in any position, with or without probe.

6. Ruggedness—Being entirely enclosed, there is nothing to be broken or damaged—cannot be injured by excessive amplitude.

Write for detailed bulletin.

Electrical Research Products Inc.

SUBSIDIARY OF

Western Electric Company

195 BROADWAY, NEW YORK, N. Y.

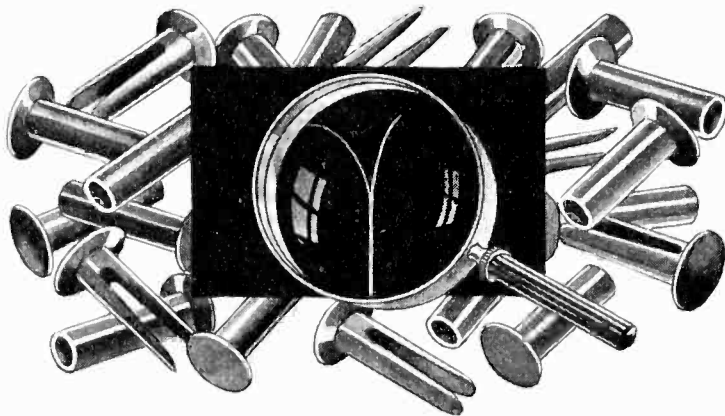

When PRECISION Counts

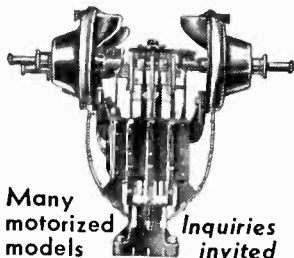

Many motorized models available in single stroke and multiple drive

Inquiries invited with samples of work you wish to do

There is one item in your specifications you can decide upon without hesitation—T R & S Rivets. T R & S quality means every rivet, no matter how many thousands you need, is usable; rivets of uniform preciseness, accurately gauged to drive with smoothness, to clinch with non-brittle efficiency.

We have solved the riveting problems of America's leading industrial concerns.

TUBULAR RIVET & STUD CO.

World's Foremost Producers of Rivets

WOLLASTON

MASSACHUSETTS

straightforward circuit arrangements, the tube was designed as a push-pull beam tetrode. Unusual constructional features include the use of short, heavy leads sealed directly into the molded glass bulb.

Characteristics of the tube are given. Tests show that the tube will operate as a stable class B amplifier at frequencies up to 250 megacycles. At that frequency a power output of the order of 13 watts with an efficiency of 45 per cent has been obtained. Satisfactory operation as a frequency multiplier is possible in the same frequency range. Oscillator operation has been obtained at considerably higher frequencies. The variation of output and efficiency with frequencies is shown in the article.

Regulating D-C Generators

IN DESIGNING electronic equipment for the regulation of d-c generators, it is essential to know the effect on the regulated current or voltage of all possible variables in the regulating equipment, as well as those in the generator proper. A paper, "Concerning Thermionic Regulation of Direct Current Generators," by W. C. Danforth in the July issue of the *Review of Scientific Instruments*, presents a method of treatment which enables one to appraise quantitatively the importance of any source of possible instability in amplifier or generator. The method is applied to two types of regulating equipment, detailed information of which is included for both types.

COSMIC RAYS LIGHT WORLD'S FAIR

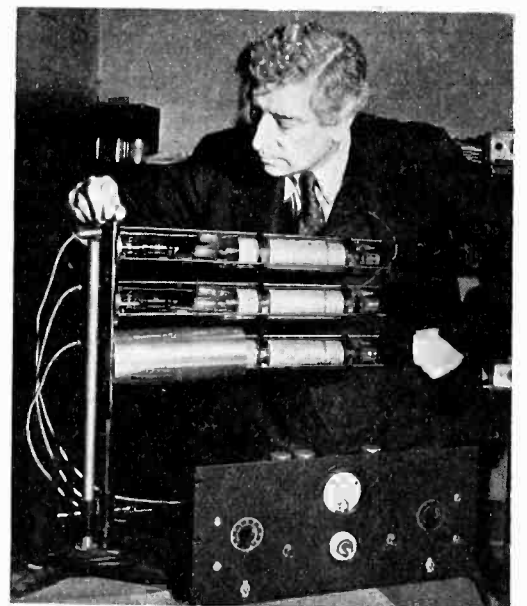

Cosmic rays set in motion mechanism which lighted the New York World's Fair. These minute electrical charges were collected from the air by means of the Geiger counter shown here and being operated by Dr. W. F. G. Swann, director, Bartol Research Foundation of the Franklin Institute

For
PROFESSIONAL USE

RECOTON

Playback
& Transcription
NEEDLES

Steel Cutting
NEEDLES

Sapphire
Cutting & Playback
NEEDLES

Write for Complete
Descriptive Literature

RECOTON
Corporation

178 Prince St., New York

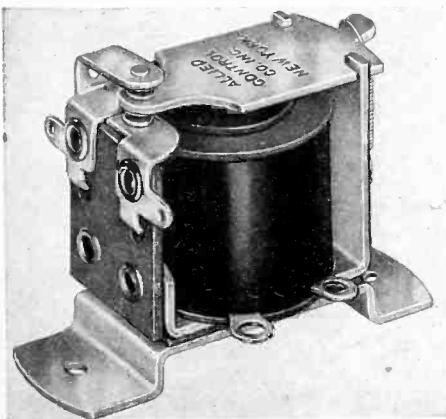

ALLIED RELAYS:

Type P.C.1—2500 Ohms—layer wound coil—condenser paper between layers—adequately impregnated—yoke, armature and pole piece made of Armco Iron—over-all dimensions 2 5/16" long, 1 1/2" high, 1 1/8" wide—designed for plate circuit of vacuum tubes.

Type P.C.2—Similar to above except coils available up to 5000 ohms.

Type P.C.3—6 volts AC; Type P.C.4—110 volts AC; Type P.C.6—6 volts DC; Type P.C.7—12 volts DC.

Also Type D relays for police, aircraft, and industrial uses.

Numerous uses as burglar alarms, light control, radio, call systems, teletype, etc.

Because of quantity production, these relays are sold at extremely attractive prices.

Write for complete descriptive literature and prices.

ALLIED CONTROL CO., INC.
227 Fulton St. New York City
Export Dept.:
Pan Mar Corp., 1270 Broadway, New York City

On Some Recent Tube Developments

HOT CATHODE vacuum and gaseous discharge tubes have found extensive application for communication and industrial control work during the past quarter of a century. However, it is only within the last few years that any extensive applications have been made of gas-filled tubes having a cold cathode. An interesting article summarizing the application of these comparatively recently developed tubes is given by S. B. Ingram in a paper, "Cold-Cathode-Gas-Filled Tubes As Circuit Elements," which appears in the July issue of *Electrical Engineering*. Such cold-cathode gas-filled tubes are composed of three elements: (1) a cathode, (2) an anode, and (3) a control anode. In such a three-element tube, there are two conduction paths. The first is that between the cathode and the main anode which is known as the main gap. The second conduction path is that between the cathode and the control anode, and is called the control gap.

Such a cold cathode tube has many interesting properties as a circuit element. Basically it may be made to perform three distinct circuit functions: those of a relay, rectifier, and voltage regulator.

The inherent characteristic of a cold cathode gas-filled tube may be summarized as follows: As the voltage across the two electrodes of a tube is increased, no current flows until a relatively high voltage is attained. At this "break-down voltage" the tube becomes conducting through ionization of the gas within it and will consequently pass a certain current. Once the tube is ionized, however, it is not necessary that the voltage across the tube be maintained at the break-down voltage to enable the tube to conduct. It is quite possible for the voltage to be considerably reduced below that of the break-down voltage and still have the tube in the ionized state. However, if the voltage across the tube is reduced too much, the tube can no longer be maintained in this state of ionization and it becomes non-conducting. The minimum voltage at which the tube remains conducting after ionization has been initiated, is called the sustaining voltage.

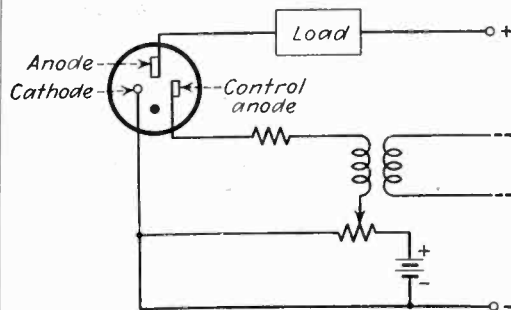

Fig. 1—Schematic wiring diagram of cold cathode, gaseous discharge tube connected to function as a relay. The voltage on the anode is adjusted so that a relatively small variation of the control anode voltage causes ionization

**CONDENSER
COIL TUBES**



... fabricated to
micrometer accuracy

An unusual combination of mechanical and dielectric strength plus extreme accuracy in drilling and machining makes Lamicaid an ideal material for these condenser coils used in radio and related electronic work. They are 1/8" thick, paper base laminated bakelite tubes, 6" and 12" in diameter.

Available in tube or rod form in all sizes—and sheets in all thickness, either with a paper or fabric base.

Lamicaid Fabricated Parts, including low power factor Punching Stock, are made in all shapes and thicknesses, punched and machined to your specifications.

Write for our latest Price Bulletin and samples of the material which you would use in your own work.



MICA INSULATOR CO., 198 VARICK ST., NEW YORK

Send me samples and prices on Lamicaid for _____

Name _____

Company _____

Address _____

E9-39



**Precision
Built**

ELECTRICAL PARTS AND EQUIPMENT



WIRE

Uniform quality of Guthman-served wire has kept our wire machines turning 24 hours a day, 365 days a year. Cotton, Silk or Colanese covering. Plain or Litz. All sizes.



I.F. TRANSFORMERS

Iron core and air core midget and standard I.F. Transformers for any frequency . . . built for precise results in your circuit. Samples made against your blue prints, by America's foremost I.F. specialists.



COILS

Midget and standard antenna and R.F. Coils and chokes. Guthman can supply any part or all of your coil needs.



WINDING MACHINES

If you need machines to wind coils, we can handle your order efficiently and economically.

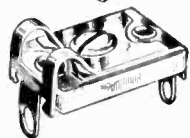

TRIMMERS

For padding, balancing, trimming or neutralizing. There is a Guthman trimmer for every commercial application, using highest quality ceramic and mica. Special types developed on request. Unexcelled uniformity and stability.



SHIELD CANS

We are exclusive fabricators of shield cans for Hegeler Zinc Co., one of the world's largest zinc smelters.

AMATEUR GEAR

Everything for both student and licensed amateur. Guthman U-10A frequency meter-motor (illustrated) is used by broadcast stations such as WCFL and WLAP, also by Navy Master Control station, NJP. Wide commercial use such as H. C. Fischer Co., diathermy manufacturers. Details on request.

ANTENNA LOOPS

New type basket weave aerials to your exact requirements.

EXPORT

We maintain a large export division. Guthman products are shipped all over the world.

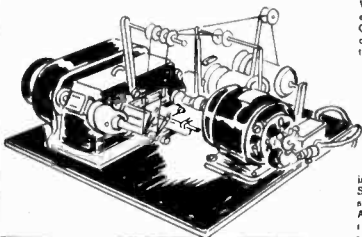

OUR COMPLETE ENGINEERING DEPARTMENT

is at your service. Send specifications or standards. SAMPLES AND PRICES will be rushed to you on request.

EDWIN I. *Guthman* & CO., INC.



400 S. PEORIA ST. CHICAGO, U. S. A.

CABLE ADDRESS: GUTHCO-CHICAGO

The operation of the cold-cathode tube as a relay may be explained with the assistance of Fig. 1. In order that no conduction will occur normally, it is necessary that the supply voltage be greater than the sustaining voltage across the main gap, but less than the main gap breakdown voltage. If a voltage exceeding its break-down value is applied to the control gap, the resulting ionization will initiate conduction in the main gap and the anode voltage will fall to the main gap sustaining voltage. The tube therefore becomes conducting in the main gap and the current through the tube and load is limited by the external circuit impedance. Conduction will continue until the circuit is open or the anode voltage maintained below the main gap sustaining voltage for a sufficiently long time for the tube to deionize. The control circuit is initiated by the voltage applied to the control electrode which is determined by the steady bias voltage as well as the incoming signal voltage. The cold-cathode tube used as a relay thus becomes a very sensitive device.

The second circuit function which can be performed by means of cold cathode tubes is that of rectification. The cold cathode tube rectifier depends for its operation upon an asymmetrical property of the glow discharge occurring within the tube. Such asymmetrical electrical characteristics may be obtained by building a glow discharge tube with two electrodes. One of these

electrodes is large and coated with a material whose work function is low, while the other is small and uncoated. The rectifier circuit of a three-element cold cathode tube is shown in Fig. 2.

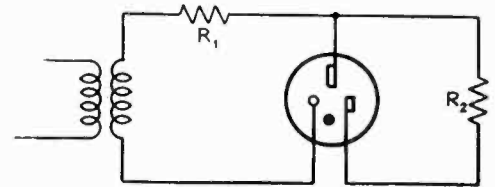

Fig. 2—Cold cathode gaseous discharge tube connected in a rectifier circuit, with the control anode and main anode connected together through R_2 .

It will be observed that this schematic wiring diagram is similar to that which would be employed for a two-element tube, with the exception that the control anode is connected to the main anode through the resistance R_2 . So long as no current flows in the tube, both anodes are at the same potential but as soon as ionization has been initiated, the control anode voltage is less than the main anode voltage by the drop in the resistor R_2 . The current through the tube then flows from the cathode to the main anode.

The voltage regulating property of the cold cathode tube is based upon the flatness of the current-voltage characteristics between the anode and main cathode. The sustaining voltage is practically independent of the current through the tube. For

*When you want
'the Best'...*



ALLIED RECORDING PRODUCTS CO.
126 W. 46th STREET NEW YORK, N. Y.

Cable: ALLRECORD

this reason, variation in the supply voltage will be practically entirely taken up in the series resistance, R_s , in the two modifications of the voltage regulating circuit shown in Fig. 3. The regulator voltage will in general vary less than 5 per cent from no load to full load and variations from tube to tube can usually be held to within ± 5 per cent of the nominal value. In the

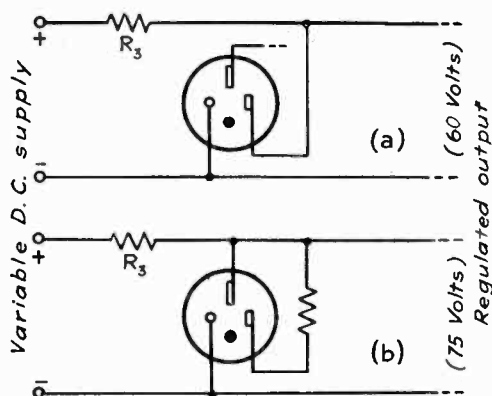

Fig. 3—Wiring diagrams of the cold cathode three element gaseous discharge tube connected as a voltage regulator. In (a) the control electrode is not employed, whereas in (b) the relay principle has been used to reduce the starting voltage

lower diagram of Fig. 3, the relay principle has been used to reduce the starting voltage, exactly as it is when the tube is used for rectification.

The author points out the similarity of the cold cathode tube with the ignitron and the thyatron. The three types of tubes are practically similar although they differ so widely in their operating characteristics that in any particular case, no doubt will exist as to which device is the practical one to use. An accompanying table summarizes in a brief, though necessarily incomplete way, the comparative characteristics of the three classes of gas-filled control tubes.

The author shows wiring diagrams illustrating circuit applications of cold cathode tubes. These schematic wiring diagrams show the use of the tube in a photoelectric relay, a square wave oscillator, a timing device, relaxation oscillator and as a control circuit element depending upon phase shift. A schematic diagram is also shown of the use of four of these gas discharge tubes in a four-party selector ringing circuit. With this application a relatively large number of tubes has already found application. Two of the ringers are connected to one side of the line, and two to the other. The ground is used to complete the return circuit. By selective operation of the two ringers on one side of the line a ringing signal is used which consists of an alternating voltage on which is superimposed a direct voltage. The cold cathode tubes functioning as rectifiers are placed in series with the ringers and are oppositely cold in the two cases. One ringer responds to positive superimposed voltage, the other to negative.

THE MOST COMPLETE CATALOG

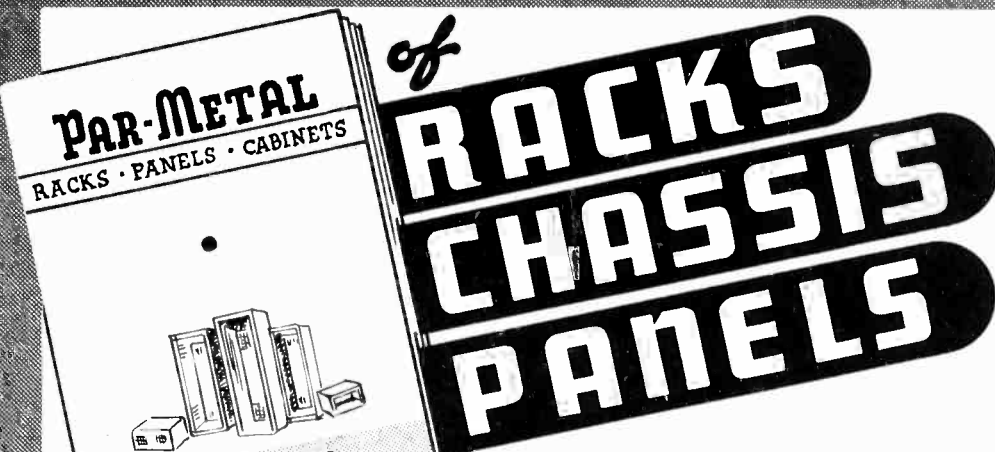

of
**RACKS
CHASSIS
PANELS**

JUST OFF THE PRESS!

And the most complete line in the industry. Two big sections: Amateur and Commercial—devoted to relay racks, enclosed racks, transmitter racks, all purpose metal cabinets, several new types of rack panels, speaker cabinets, and new models of amplifier foundation chassis. Many new De Luxe chromium trimmed, streamlined models in both black or grey ripple finish are included.

Any Amateur, Serviceman, Engineer or Experimenter planning a new Rig owes it to himself to get a copy of this great catalog at once! It's FREE for the asking!

PAR-METAL PRODUCTS CORPORATION
3523-41 ST. LONG ISLAND CITY, N. Y.

CONSTANT VOLTAGE

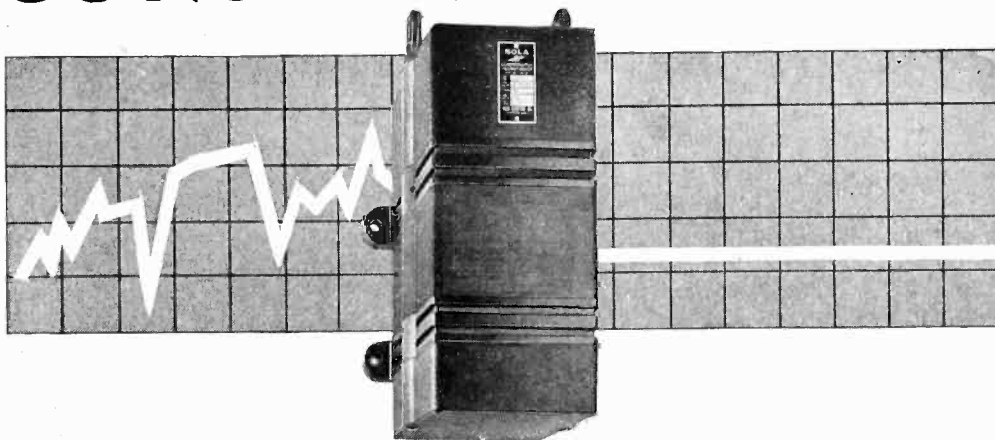

TRANSFORMERS

... wherever the operation of electrical equipment is affected by line voltage variations this new Sola Constant Voltage Transformer offers a practical solution to the problem. Automatic and instantaneous voltage regulation. No moving parts, nothing to adjust or lubricate.

WRITE FOR CATALOG SM-22

also
AIR COOLED INDUSTRIAL TRANSFORMERS
LOW VOLTAGE SIGNAL and CONTROL TRANSFORMERS
FLUORESCENT LAMP REACTORS
MERCURY VAPOR LAMP TRANSFORMERS
OIL BURNER IGNITION TRANSFORMERS
FILAMENT and HIGH VOLTAGE X-RAY TRANSFORMERS
DOOR-BELL and CHIME TRANSFORMERS

SOLA ELECTRIC COMPANY
2525 CLYBOURN AVENUE • CHICAGO, ILLINOIS

if it can be improved

HUNTER CAN DO IT!



if it can be made **HUNTER CAN MAKE IT!**

NEW BOBBIN

STURDIER • BETTER INSULATED • LOWER COST

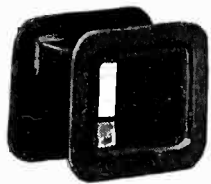

SQUARE...RECTANGULAR...

FOR SMALL TRANSFORMERS . . . REACTORS
. . . A. C. RELAYS . . . SOLENOIDS . . . VIBRA-
TORS

ROUND...

FOR SOLENOIDS . . . RELAYS . . . SIGNALS . . .
BELLS . . . BUZZERS

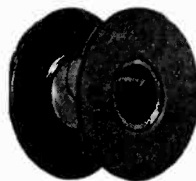

Patent Pending

Write for Prices and Samples

PRECISION PAPER TUBE COMPANY

Manufactures Square, Rectangular, Round Tubes

2033 W. CHARLESTON STREET

CHICAGO, ILLINOIS

Heavy Duty, Hi-Power Genemotors

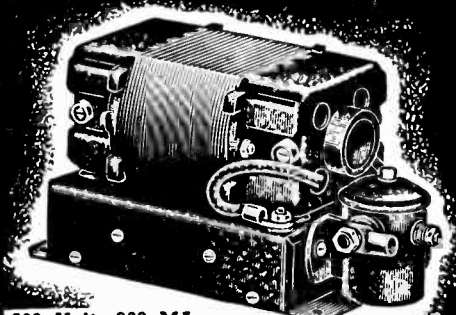

500 Volt, 200 MA.
(Motor Only, 7"x4"x27/8"—Weight 10 lbs.)

For Hi-Gain Amplifiers, Ultra Short Wave Two-Way Police Radios, Aircraft Radios, etc. Six years of successful performance.

There is a Carter Genemotor for every requirement.

SMALL SIZE—NO HASH
LIGHT WEIGHT—RELIABLE
Write for Complete Information

CARTER MOTOR CO.

1608 MILWAUKEE AVE.

CHICAGO, ILL.

An Electronic Microammeter

A TWO-STAGE direct coupled amplifier circuit with negative feedback which can be used for measuring small direct current is described by Shepard Roberts in an article, "A Feedback Micro Microammeter" in the June issue of the *Review of Scientific Instruments*. The device is used primarily for measuring current of low order, and has a range down to 10^{-11} amperes full scale.

A diagram showing the essential operation of the circuit is given in Fig. 1.

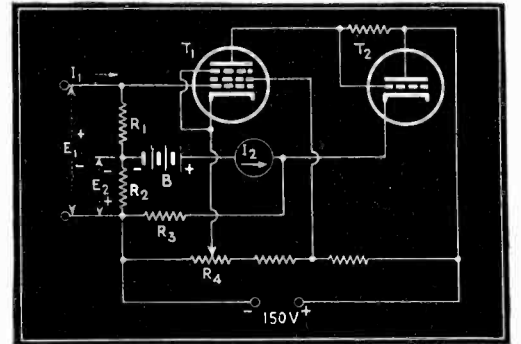

Fig. 1—Schematic wiring diagram of two tube, direct coupled, negative feedback micro-ammeter

In this diagram, the adjustable resistor R_4 , which controls the bias on T_1 , serves as a means of balancing the amplifier so that I_2 is 0 when the input voltage is 0. When this condition obtains, the plate current in T_2 is just equal to that in R_3 , and the voltage drop across R_3 equals the voltage of battery B . After balancing, it is desired to measure an unknown current, I_1 , which flows in the direction shown. This current causes a voltage drop in R_1 which unbalances the amplifier, so that I_2 is no longer 0.

The theoretical relations underlying the fundamental design of this circuit are derived mathematically by the author who shows that an important feature of this amplifier is that the required input voltage E_1 , is smaller than usual with a similar circuit. A full scale deflection of the meter is obtained when E_1 is of the order of 4 millivolts. The low input voltage and low effective resistance are an advantage when the instrument is used for measurements of high resistance, or for measurements of grid current in a vacuum tube.

A description is given of a self-contained, a-c operated unit capable of operating a 5 milliamperere recorder.

Analysis of Frequency Multiplier

THE MATHEMATICAL and theoretical treatment of the characteristics of a vacuum tube frequency multiplier using a triode, is given by H. Uchida, in an article "Analysis of Frequency Multiplier," which appears in the July issue of the *Electrotechnical Journal*, published by the Institute of Electrical Engineers of Japan. The discussion is limited to the use of a frequency multiplier as a doubler or tripler, and

HEADQUARTERS FOR RELAYS

THIRTY years of concentration in the signalling and control art by The Autocall Company has won for their devices and systems a decided preference. A broad line of production items as well as special units to customer's specifications are available.

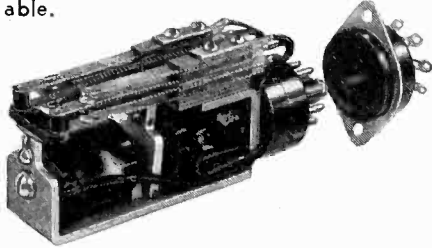

JACK TYPE REDJ-1

Contacts positioned by momentary electrical operation of coils and mechanically maintained by armature. One of several Jack Type Relays in the Autocall line.

Write for catalog!

The Autocall Co.
SHELBY . . . OHIO

- RELAYS
- INDICATING DEVICES
- BELLS, HORNS, CHIMES and MISC. EQUIPMENT
- TERMINAL DISCONNECT BLOCKS
- ANNUNCIATORS
- LIQUID FLOW DEVICES
- CODING TRANSMITTERS
- SIGNALLING SYSTEMS - ALL TYPES

New SLO-BLO LITTELFUSE



① SPRING ② RESISTOR ③ FUSE LINK

Where it is used! Has "high lag"—to fuse fractional H. P. motors, solenoids, magnets, vibrator circuits, portable tools, electric fences, with low current applications having inductive or capacitive surges, high starting loads, continuous intermittent duty, etc.

Why used! Outlasts a regular fuse because these services might crystallize a regular fuse link.

Get data! Write today for information on this new Slo-Blo Littelfuse—how to determine the one to use from new current curves—how it can save you extra expense.

LITTELFUSE INCORPORATED
4248 LINCOLN AVE. CHICAGO, ILL.

the action of the frequency multiplier is explained by making comparisons with that of a class C amplifier. The principles of design are discussed by means of an equivalent circuit which idealizes the characteristic of the class C amplifier.

Theoretical study in detail of the various characteristics concerning the frequency multiplier was made by assuming the characteristic curve of the vacuum tube to be a straight line. An attempt is made to make clear the basic idea for the design of a frequency multiplier, and an example is given to make easier an understanding of the theory. At present multi-electrode tubes are usually used for frequency multiplier purposes. However, this paper is limited to the use of three-element tubes, but the principles involved are common to all classes of vacuum tubes.

Distortions in the Output Stage

THE AUGUST ISSUE of the *Wireless Engineer* contains an article by A. J. Heins Van der Ven, entitled "Output Stage Distortions," which gives the measurements on different types of tubes used in the output stage of audio amplifiers. According to the author's summary, after an introduction dealing with the disturbing effects of distortion and the insulation used for its measurements, details are given of the series of measurements which are carried out on tube combinations comprising a preamplifier in conjunction with different types of output tubes. Results show that the modern output tetrode is a better safeguard against overload in extremely loud passages than is the triode. In the absence of inverse feedback, distortion is greater in a tetrode than in a triode, but, for an output equal to one-third of the anode dissipation (maximum efficiency for the output triode) distortion is found to be below the permissible value of 5 per cent. Contrary to what is commonly supposed, this larger distortion is not due to a larger third harmonic, but solely to additional second harmonics.

The great sensitivity of output tetrodes enables distortion to be greatly improved by inverse feedback without lowering the sensitivity and power output level, as would be the case with output triodes. Along with push-pull circuits, which have not been dealt with in this article, a tetrode output tube is therefore appropriate whenever high standards of reproduction quality are demanded.

Tetrode output tubes or beam power show great similarity to the pentode, but their output at load resistances above the optimum value is adversely affected by secondary emission phenomena which are still present. The main drawback, however, of this type of output tube is that a phase angle of the load impedance has a pronounced influence upon the output.

Portable INSTRUMENTS

- for development
- for experimentation



• The need for portable instruments is a broad one, especially in laboratories, schools and industrial setups. To meet this demand Triplett has available handy instrument stands for any 3" instrument; and also offers a complete line of portables in 3" and 5" sizes.

Instrument stands are widely used for purposes requiring portable instruments or where space does not permit mounting on a regular panel. They are especially suitable where portable galvanometers are needed. Mounted in this handy, all-metal stand any Triplett 3-inch round instrument may be used as a portable unit. Instrument stands are available with two, three or four binding posts. Black wrinkle finished all metal case—sloping panel—4"x4"x3 1/2".



PORTABLE

Model 325 • 3" Size

Models 325 (DC) (335 AC) for laboratory, shop bench, and special purposes. Tilting feature permits adjustment of instrument to any angle for accurate reading.

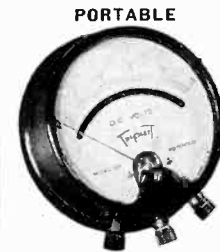

PORTABLE

Model 525 • 5" Size

Has mirror scale and knife edge pointer for extreme accuracy in reading.

Both models 325 and 525 are regular indicating instruments in portable styles, included in the Triplett line in many ranges.

Write for Catalog
THE TRIPLET ELECTRICAL INSTRUMENT CO.
Section 239 Harmon Ave. Bluffton, Ohio

TRIPLET
Precision
ELECTRICAL INSTRUMENTS

THE INDUSTRY IN REVIEW

A Five Hour Continuous Tape Recorder

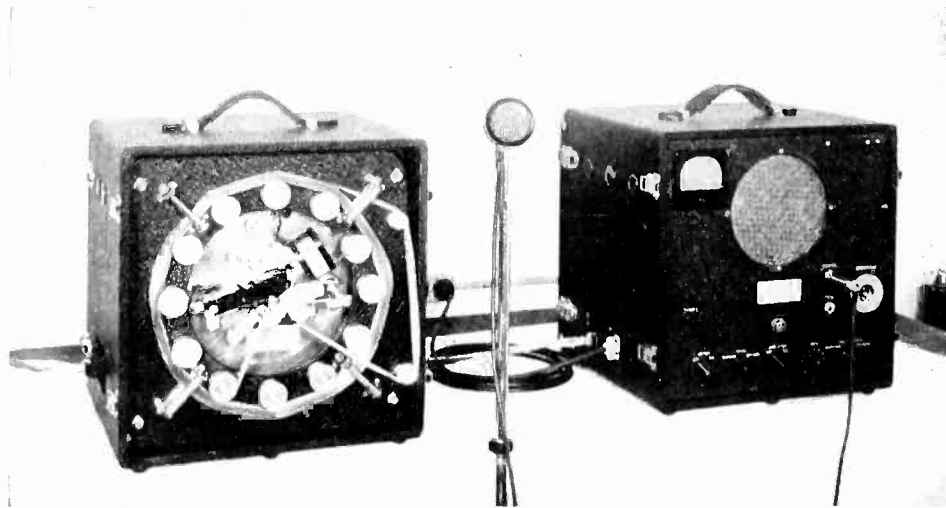

Fig. 1—The tape is drawn from the inside of the reel, past the recording or pickup unit and to the outside of the reel. The frequency range of the unit is from 50 to 5500 cps

FIVE continuous hours of recording are provided in a new film recorder by the Fonda Corp., 70 Pine St., New York. The sound is recorded on a continuous strip of ordinary amateur 16mm acetate film in a spiral groove which runs from one edge of the film to the other providing 24 grooves across the width. The frequency range is from 50 to 5500 cps. There are separate recording and pickup units. The recording needle is of diamond and the pickup needle is of sapphire.

A feature of this recorder is the very low scratch level which is accomplished by two means. In the conventional film recording, the needle displaces the celluloid in the manner shown in Fig. 2a. A ridge is built up on either side of the groove. By the use of a yieldable bed in the Fonda recorder, the film material is displaced in the manner shown in Fig. 2b which has the effect of reducing the scratch level. Also, the point of the pickup needle is of slightly greater radius than the point of the recording needle. Therefore, the pickup needle does not ride the bottom of the groove, but only the sides of the groove where the signal is impressed. In this manner, the scratch in the bottom of the groove is not reproduced. It also has the effect of increasing the life of the film to a considerable degree.

As shown in the photograph, the record consists of a loop of film of sufficient length to provide any time of recording up to five hours. It is mounted in the recorder so that it rides on a series of rollers which are located to form a circle. A sprocket wheel draws the film across the recording or reproducing head after which the film is drawn to the outside of the loop.

The recorder is loaded and the record locked into place by a simple mechanism.

The cost of the recording medium, 16mm amateur movie film, is considerably less than the conventional acetate records for the same time of recording. For conditions where good quality is required, such as the recording of music, the record is drawn across the

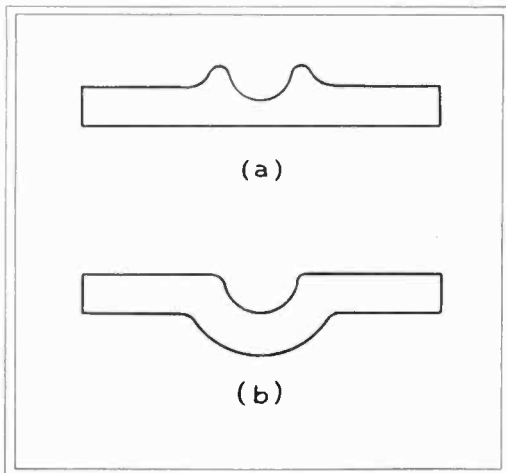

Fig. 2—Cross-section of tape showing groove made with conventional recorder (a) and Fonda recorder (b)

recording head at the rate of 48 feet per minute. For conditions where the only requirement is intelligibility of speech, a model is provided with a record speed of 36 feet per minute or a frequency range up to approximately 3500 cps with the corresponding saving in the cost of the record.

The advantages of a long period of recording are obvious. In commercial applications, long speeches or conversa-

tions may be recorded with a minimum of bother and with a single unit. In the more esthetic applications, complete symphonies or operas may be recorded without interruption.

News

♦T. E. Shea was elected vice-president of ERPI succeeding H. G. Knox who resigned on the advice of his physician. Mr. Shea, formerly of Bell Labs, becomes director of engineering and will be in charge of all technical activities in both New York and Hollywood. . . . W. G. H. Finch of Finch Labs has been granted a license to operate a broadcast station with the call letters W2XWF on 42.18 Mc at 100 watts. . . . P. Blakiston's Son & Co., publishers of scientific and medical books, has been purchased from the estate of Kenneth M. Blakiston by Horace G. White who was the executive vice-president. . . . Wholesale Radio Service Co., Inc. has changed its name to Radio Wire Television, Inc. It is now a subsidiary of the new Radio Wire Television Corp. of America. . . . Messrs. Jones and Orme of the United Sound Engineering Co. and Washington Foundry Co. respectively, have joined forces to form the Jones-Orme Co., 2233 University Ave., St. Paul, Minn. They will manufacture intercommunication systems and special laboratory instruments. . . . At the West Virginia State Exhibit at the New York World's Fair is what is believed to be the smallest metal tube ever produced. It is 0.0026 inches in diameter with the hole about one-third this size and wall thickness of 0.0007 inches. The tube was drawn by the Superior Tube Co., of nickel produced at the Huntington, W. Va. plant of the International Nickel Co. . . . The first Marconi Memorial Scholarship given by the Veteran Wireless Operator's Association has been awarded to Robert Barkey, 16, a graduate of Stuyvesant High School, New York. The scholarship provides two years' study at the RCA Institutes of New York. . . . Blaw-Knox Co. announces the appointment of Lawrence E. Joseph as executive officer in charge of its Blaw-Knox Division. . . . RCA announces a net profit for the quarter ending June 30 of \$724,091.11. . . . It is reported that the NBC television signals from the Empire State Building are being picked up regularly and clearly on Cape Cod, 185 miles air-line from

Outstanding VALUE

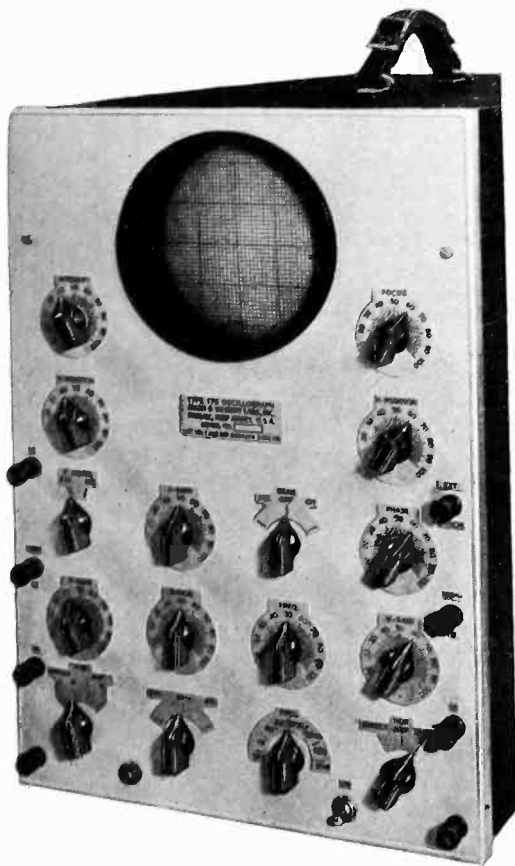

• The universal acceptance accorded DuMont Types 175 and 175-A Cathode-Ray Oscillographs, has exceeded our fondest expectations. Within a few months we have seen these instruments go into leading educational and industrial laboratories the world over, wherever an exceptionally convenient and flexible oscillograph, having a wide operating range, is required for many different applications.

These low-cost instruments incorporate many important features heretofore found only in larger, more expensive and less portable instruments. Hence their exceptional popularity.

We shall be pleased to send descriptive literature on these and other DuMont instruments, upon request. Meanwhile, submit your cathode-ray problem.

ALLEN B. DU MONT LABORATORIES, Inc.

Passaic • New Jersey
Cable Address: Wespexlin, New York

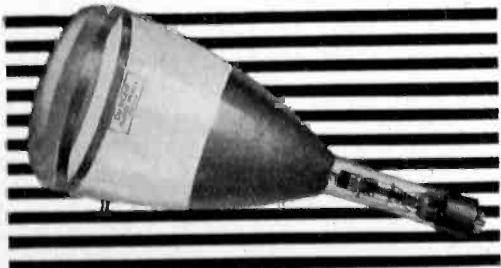

New York. . . The FCC has changed the call letters of some of the short wave broadcast stations to remove them from their experimental status. Columbia's W3XAU is now WCAI; General Electric's W2XAF and W2XAD are now WGEO and WGEA respectively and W6XBE is now KGEI; and the two Westinghouse stations, W8XK and W1XK are now WPIT and WBOS respectively. . . A simple instrument for measuring the refractive index of glass has been developed by Frank Benford of the GE Research Labs. It is accurate to two decimal places and is equal to most laboratory tasks. . . Industrial Instruments, Inc. is now located in considerably larger quarters at 156 Culver Ave., Jersey City, N. J. They have organized a new Special Equipment Division to specialize in the manufacture of custom built electrical test equipment. . . The Head of the Lakes Broadcasting Co. has been granted permission by the FCC to build an experimental 1000 watt frequency modulation transmitter at Duluth, Minn. to operate on 26.3 Mc. . . George W. Jernstedt of the Meter Division, Westinghouse Electric & Mfg. Co., Newark, N. J. has been awarded the Benjamin Garver Lamme Graduate Scholarship for the year 1939-40 which provides \$1500 tuition and expenses for advanced study. . . C. H. Thordarson, founder and president of Thordarson Electric Mfg. Co. has been awarded the Cross of the Icelandic Falcon Order by the Danish and Icelandic governments. It is given to those of Icelandic or Danish

BAND LEADER BECOMES CONTROL OPERATOR



Microphones attached to the various instruments of an orchestra feed individual amplifiers whose gain may be separately controlled as well as the volume of the ensemble. By this means, emphasis may be given to any portion of the band through the usual loud speaker or public address system. The controls are available to Buddy Wagner, band leader who has invented this control board

SENSITIVE ELECTRONIC AC VOLTMETER MODEL 300



- New operating principle.
- 10-150,000 cycles.
- 1 millivolt to 100 volts in five ranges (to 1,000 and 10,000 volts with multiplier).
- Logarithmic voltage scale and uniform decibel scale.
- A-C operation, 115 or 230 volts, 50-60 cycles (rack mounting and battery-operated models also available).
- Permanent calibration, unaffected by variation in line voltage, tubes, etc. Accuracy 2%.
- Can also be used as an amplifier (70 DB gain) flat to 100,000 cycles.

MODEL 505 ARTIFICIAL EAR



For use with Model 300 Voltmeter for measurements of the efficiency and frequency response characteristics of telephone receivers and hearing aids. Comprises rubber enclosed auricular cavity and canal, acoustical resistance and a microphone to indicate the acoustical pressure developed. Suitable for both research and production testing.

Write for Bulletin 6A

Ballantine Laboratories, Inc.
BOONTON NEW JERSEY

New

PUSH-PULL ELECTRONIC VOLTMETER- OHMMETER

.05-5000 Volts DC in 9 Ranges!
.01 Ohm-1000 Megohms
in 7 Ranges!



IT'S THE
Rider Volt-Ohmyst!

HERE'S a laboratory instrument with ranges so wide it will not only take care of today's engineering requirements—but tomorrow's as well.

It's the Rider Volt-Ohmyst and with it you can measure DC voltages in high resistance photo-cell circuits, television circuits, bias cells, operating voltages across tuned circuits with the signal present—with surprising speed and accuracy. This instrument covers the actual operating voltage. No circuit loading. Its input resistance of 160,000,000 ohms on all ranges between 500 volts and 5000 volts makes the Rider Volt-Ohmyst a universal instrument—one that has minimized obsolescence. Get full details and specifications from your RCA Test Equipment Distributor—or write to the address below.

The Rider Volt-Ohmyst is Stock No. 163—net price \$57.50.

Over 335 million RCA radio tubes have been purchased by radio users... in tubes, as in Parts and Test Equipment, it pays to go RCA All the Way.



Test Equipment

RCA Manufacturing Co., Inc., Camden, N. J.
A Service of the Radio Corporation of America

descent who have contributed some outstanding achievement to the world. . . . The Capitol Radio Engineering Institute, Washington, D. C. has added a course of Practical Television Engineering to the regular radio engineering course. . . . The Erwood Sound Equipment Co., 224 W. Huron St., Chicago has been formed by John and Joe Erwood to specialize in the manufacture of sound equipment. . . . More than 100 GE radio and television engineers and research men were guests of the company at a three day camp conference at Bridgeport, Conn. Business sessions were devoted to the technical aspects of radio and television transmitters, receivers and tubes, to current manufacturing problems and to new developments of the research department. . . . The Board of Directors of Union Carbide and Carbon Corp. have approved an agreement for the acquisition by Union Carbide of all the assets of Bakelite Corporation. Bakelite stockholders will receive 187,500 shares of Carbide common stock, 1 1/4 Carbide shares going for each Bakelite preferred share and the rest to be divided among the common stockholders. . . . RCA and Decca are issuing licenses to broadcasters for the use of their records. . . . John F. Rider is to conduct a series of radio service meetings in 35 cities during the Fall months under the sponsorship of RCA.

Literature

Oscillographer. Contains an article entitled Production Test of Ignition Coils with the Cathode-ray Oscillograph. Allen B. DuMont Labs., 2 Main Ave., Passaic, N. J.

Sound Measurements. Also development of sound measuring equipment in Vol. 5, Nos. 1 and 3 of Sound Advances. Sound Apparatus Co., 150 West 46th St., New York.

High Fidelity Receivers. Discussed in Scott News. E. H. Scott Laboratories, Inc., 4450 Ravenswood Ave., Chicago.

Phonograph Pickup Design. Discussed in Vol. 3, No. 2 of Brush Strokes. Brush Development Co., 3322 Perkins Ave., Cleveland.

Variac. New improved models, Type 50-A for 115 volts (5 kva) and Type 50-B for 230 volts (7 kva), are described in the Experimenter for July. General Radio Co., 30 State St., Cambridge A, Mass.

Transformers. Also automatic voltage regulators described and list prices given in Catalog No. 400 by Thordarson Electric Mfg. Co., 500 West Huron St., Chicago.

Pyrometers. And Resistance Thermometers are described in Catalog No.



radio graveyard?

WELL . . . YES AND NO

It's true we do carry quite a stock of hard-to-get items . . . radio parts long out of manufacture. But that's only one feature of our talked-about service. You'll find here also a complete line of 1940 receivers, for example, and the parts, tubes and equipment to build them. Graveyard or radio world of Tomorrow, we're plenty alive ourselves. Filling your order inside of 24 hours is our specialty. Try us out. Send for brand new FREE 1940 catalog No. 78. Just out!

Radio Wire Television Inc.
formerly WHOLESALE RADIO SERVICE CO., INC.

LAFAYETTE RADIO

NEW YORK 100 Sixth Avenue
CHICAGO 901 W. Jackson Blvd.
ATLANTA 265 Peachtree St.
BOSTON 110 Federal St.
NEWARK 24 Central Ave.
JAMAICA, L. I. 90-08 168th St.
BRONX, N. Y. 542 E. Fordham Rd.

PROFESSIONAL SERVICES

(Rates on Application)

ELECTRICAL TESTING LABORATORIES

Characteristics of Vacuum Tubes
Tests of photo cells, glow lamps, crater lamps.
Tests of electronic and optical devices
East End Avenue and 79th Street
New York, N. Y.
Phone: Butterfield 8-2600

INTERNATIONAL ELECTRONICS, INC.

DESIGN AND DEVELOPMENT
Radio Television
Sound Electronics
MANUFACTURING METHODS
Condensers Tubes Resistors
Vibrators Lamps Speakers
630 Fifth Avenue New York, N. Y.
Cable: Interengin, New York

HAROLD J. McCREARY

Mem. A.I.E.E. & W.S.E.
Consulting Engineer
Laboratory Facilities
Research Electronics
Development Television
Design Radio
Factory Practise Railroad Signaling
Patent Studies Telephony
105 W. Adams St. Phone State 4003 Chicago, Ill.

PHOTOBELL CORPORATION

Consultation—Designs—Models
Photo-electric applications for industry
COUNTING: cans, cartons, people
CONTROLS: machinery, weighing, signs
ALARMS: burglar, smoke, etc.
125 Liberty Street, New York City

1101E by C. J. Tagliabue Mfg. Co., Park and Nostrand Aves., Brooklyn, N. Y.

Instrument Transformers. A new line described in a 12 page booklet, No. B-2213, by Westinghouse Electric and Manufacturing Co., East Pittsburgh, Pa.

Microphones. Catalog 152 covers crystal, dynamic and carbon microphones, in uni-directional, semi-directional, general purpose and communications models. Shure Brothers, 225 W. Huron St., Chicago.

Relays. A large variety of relays are shown and list prices given in Catalog No. 2 by Leach Relay Co., 5915 Avalon Blvd., Los Angeles.

Master Catalog. Great variety of radio items and equipment shown in 188 page catalog by Radio Wire Television, Inc. (formerly Wholesale Radio Service Co.), 100 Sixth Ave., New York.

Soldering Iron Bracket. Described in booklet by Kester Solder Co., 4201 Wrightwood Ave., Chicago.

Rheostats. Bulletin 1620 describes important improvements in Jagabi sliding-contact rheostats. James G. Bidle Co., 1211-13 Arch St., Philadelphia.

Record changers, motors, pickups, etc. Described in a 16 page catalog by Garrard Sales Corp., 296 Broadway, New York.

Fish Rule. Graduated in fisherman's inches for the measurement of fish, presented in booklet telling of personnel and inside workings of company. Littelfuse, Incorporated, 4238 Lincoln Ave., Chicago.

Tremendous Trifles. Emphasizes the importance of small parts (springs, bolts, contact points, etc.) and gives technical data on nickel and nickel alloys. International Nickel Co., 67 Wall St., New York.

Audio Noise Measurements. As applied to transformers on page 13 and Electric Means for Measuring Low Pressures in Mercury Arc Rectifiers on page 11 of Electrical Review by Allis-Chalmers Mfg. Co., Milwaukee, Wis.

Taper Rectifiers. And d-c power units for use in telephone, utility, industrial and signal service described in Bulletin TC-51 by Fansteel Metallurgical Corp., North Chicago, Ill.

Magnet Wire and Coils. Described in handbook by Anaconda Wire & Cable Co., 25 Broadway, New York.

Thermo-Magnetic Relays. For protection of a-c motors, generators, transformers, etc., described in Catalog 12-a. Also, Catalog 123 describes a-c and d-c instruments. Roller Smith Co., 1766 West Market St., Bethlehem, Pa.

Those who KNOW say, "TURBO"

"Leads in EVERY important production factor"

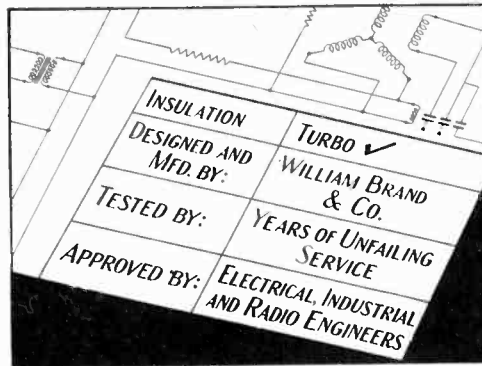

- 1—Highest dielectric values
- 2—Tensile strength unsurpassed
- 3—Flexibility; withstands every practical bending and twisting operation
- 4—Water, acid and moisture proof
- 5—Smooth inside bore accelerates "snaking" and "fishing" operations

These claims are not merely self-assertive but become facts when viewed in the light of experience by practically every leading electrical manufacturing organization with Turbo flexible varnished tubing and saturated sleeving.

To be so substantiated must compel recognition as the outstanding safeguard for standard electrical conductors.

Such a reputation must have been earned in the field of electrical insulation. Remember also our consistent practice of shipment the same day as order—large or small—is received.

Mica plate and products—varnished oil tubing, saturated sleeving, varnished cambric, cloths and composites

WILLIAM BRAND & COMPANY

270 Fourth Ave., New York

217 No. Desplaines St., Chicago

FOR ACCURATE, DEPENDABLE high frequency CRYSTAL CONTROL

The type MO2 and MO3 Bliley High Frequency Quartz Crystal Units are designed to provide accurate, dependable frequency control under the adverse operating conditions encountered with mobile and portable transmitters. Catalog G-11 contains complete information. Write for your copy.

BLILEY ELECTRIC CO.
UNION STATION BLDG. ERIE, PA.

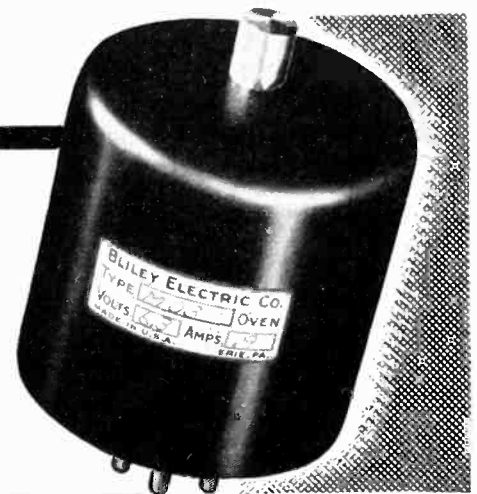

CETRON PHOTO CELLS and RECTIFIERS

the accepted standard
with which all others are compared.

CONTINENTAL ELECTRIC CO.
715 HAMILTON ST. GENEVA, ILLINOIS

Circulars and Prices on Request.

*"As
Advertised"*

WIBW

**ADDS
50%
to coverage and
sales
effectiveness**

Our advertising promises for increased performance and efficiency are backed up once again by the amazing results enjoyed by WIBW—Topeka, Kansas. Says WIBW, "The ultra-modern transmitter, antenna and ground system is the newest and most efficient type in America". The 445 foot LINGO RADIATOR is one of the tallest of this type in the world . . . and is added proof to alert engineers that Lingo claims of low cost and plus performance are based on actual results and are strictly "as advertised"!

**Complete Technical Folder
Sent On Request**

Write for your copy and send complete details on location, power and frequency of station, so we can show you how Lingo can meet your particular requirements. No obligation, of course.

**JOHN E. LINGO
& SON, INC.**

Dept. C-9 Camden, N. J.

**LINGO
VERTICAL
TUBULAR STEEL
RADIATORS**

Capacitor-Motors. What they are and why they are used. Booklet 2420 by General Electric Co., Schenectady, N. Y.

Amplifiers and sound systems with accessories are described in Catalog 139 by The Webster Co., 5622 Bloomingdale Ave., Chicago.

Controllers and distributing apparatus for electric light and power described and list prices given in condensed Catalog 395 by Bull Dog Electric Products Co., Detroit.

Buying Guide. Description of a large number of radio parts and a variety of equipment and prices given. Sun Radio Co., 212 Fulton St., New York.

Cable. For automotive, aircraft and marine applications of radio, power, lighting, ignition and communication. Catalog AM-1, Boston Insulated Wire and Cable Co., Dorchester District, Boston, Mass.

New Products

Carboy Pourer

A NEW TYPE SAFETY Carboy Pourer is announced by Lewis-Shepard Sales Corp., 245 Walnut St., Watertown, Mass. It is light in weight and rigidly built and may be quickly and easily handled by one man. With the

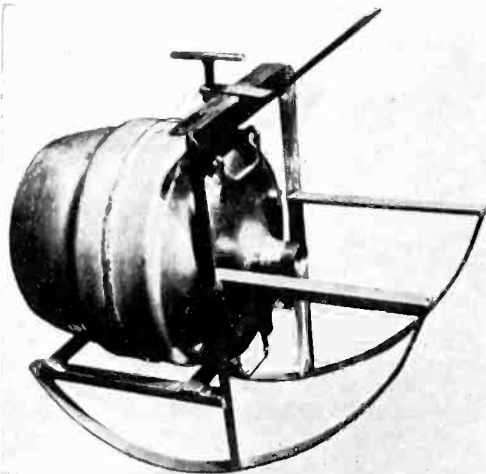

carboy resting on its base, the pourer is placed over the top and clamped securely by means of a threaded handle just below the shoulder. An easy pull on the handle brings the carboy over into pouring position, resting on a broad rocker base. Pulling the carboy pourer still further until it rests on the handle permits complete drainage of the carboy.

Industrial Noise Analyzer

AN ELECTRICAL EAR which will enable unskilled workers to detect flaws in running machinery has been announced

by Electrical Research Products, Inc., 195 Broadway, New York. This device measures the intensity of sound at any pre-selected frequency and rejects all other sounds. If any variation from the normal sound intensities are indicated, the operator is warned that the machine is defective. A band pass filter is used to pass the frequency or frequencies which are used to determine the proper operation of the machine. This instrument can be adapted to the production lines of a large variety of products and the defective units removed.

Condensers

TWO NEW LINES of condensers have been announced by P. R. Mallory & Co., Indianapolis, Ind. A group of cardboard tubular condensers, including over 50 different ratings, is de-

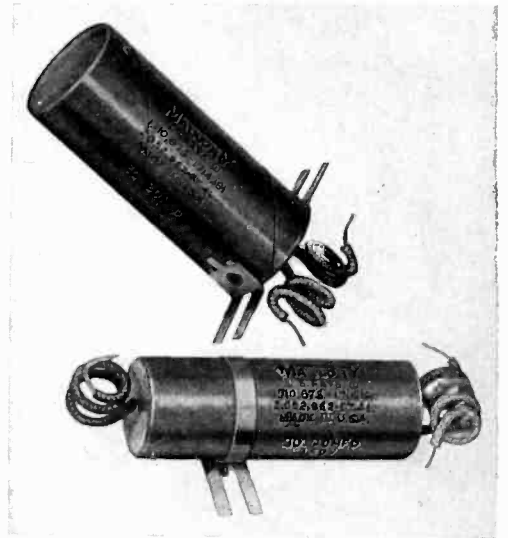

signed to cover the replacement field. The second group is a complete line of single section tubular condensers (Type BB) made with fabricated plates and contained in hermetically sealed one-piece drawn aluminum cans. An insulating cardboard cover is furnished and all units have bare wire leads.

Transmitter

A ONE KILOWATT transmitter which has high power efficiency and in which all parts are easily accessible is announced by Western Electric Co., 195 Broadway, New York. It is designed primarily for commercial broadcasting and high quality police service and makes use of features generally found only in high-power equipment. The Doherty High Efficiency Circuit is used for the first time in a transmitter of medium power. The stabilized feedback principle is also used. It maintains in the final radio signal, the clarity of the original audio signal. It achieves this result by minimizing certain undesirable products of modulation inherent in all transmitters.

Speaker Housing

A NEW SERIES of speaker enclosures embodying the Acousti-Reflex principle are announced by Operadio Manufacturing Co., St. Charles, Ill. Baffles are designed to utilize all of the en-

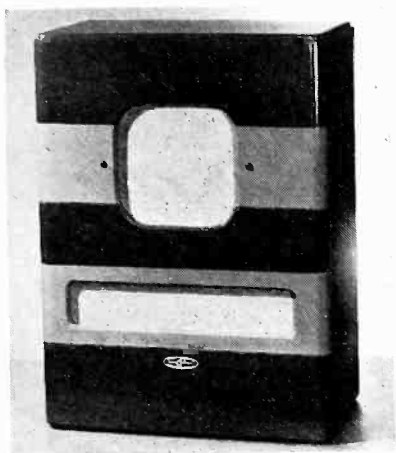

ergy emanating from the speaker cone. The sound is taken from the back of the speaker and by the Acousti-Reflex principle, projected to and out of the front of the speaker cabinet, augmenting the sound generated by the front of the speaker cone. The efficiency of speaker is increased and better coverage is effected with a lower amplifier power output.

Powerstat

A NEW LINE of Powerstat variable transformers for transmitter line voltage control and general electrical testing has been announced by Superior Electric Co., 56 Harrison St., Bristol, Conn. Units are available for single and three phase operation on 115, 230, and 440 volt circuits with output voltages continuously variable from zero to above line voltage. Capacities range up to 25 kva. A 7.5 kva model weighs 66 pounds and has a no-load loss of 40 watts. All cast parts are of aluminum alloy and units above 2 kva are wound with glass insulated wire. Electrical and mechanical specifications may be varied to meet individual requirements.

Recording Discs

ALUMINUM-CORED RECORDING blanks in six sizes ranging from six to sixteen inches in diameter are announced by RCA Manufacturing Co., Camden, N. J. The list prices are as follows: 6-inch disc, 40¢; 8-inch, 55¢; 10-inch, 80¢; 12-inch, \$1.00; 16-inch (thickness, 0.051 inch), \$1.80; 16-inch (thickness, 0.065 inch), \$2.00. They are sold in packages of 25.

Booster Coils

AUTO RADIO AERIAL Booster Coils which fit into present aerial installations without change of fittings to give increased efficiency and reduced noise

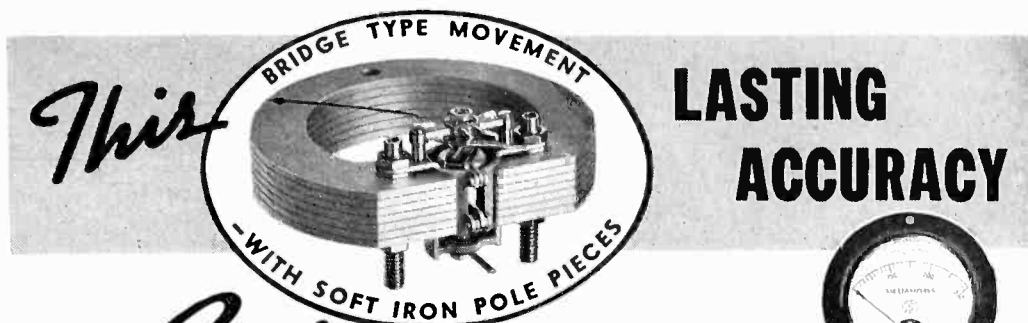

LASTING ACCURACY

Costs NO MORE!

Use SIMPSON Testing Instruments

Model 202



Model 230

• The finer Simpson movement is also the basis of a complete line of Testing Instruments. The Model 202 Roto-Ranger Volt-Ohm-Milliammeter with twelve automatically changing independent scales is illustrated above. Opposite is shown the Model 230—smallest pocket-type Volt-Ohm-Milliammeter. Ask for description of full line of testers.

SIMPSON instruments have a fighting heart—a movement with the expensive bridge-type construction and soft iron pole pieces. But thanks to modern production methods you are not asked to pay a premium price for this premium feature.

Manufacturers who build quality equipment have naturally selected these finer, more attractive instruments as the finishing touch to their product. Typical instruments are illustrated. Ask for bulletins describing ten models covering every requirement. Let us show you why so many leading manufacturers have adopted Simpson instruments.

SIMPSON ELECTRIC COMPANY
5212 Kinzie Street, Chicago, Ill.

SIMPSON

INSTRUMENTS THAT STAY ACCURATE

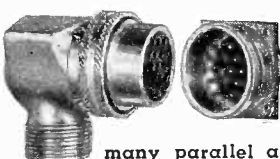
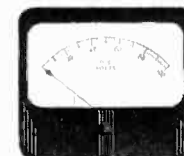

HAVE YOU A "PLUG PROBLEM"?

CANNON PLUGS are manufactured up to a standard, not down to a price . . . they are fashioned for those who demand dependability, who know that failure spells loss, perhaps disaster—as in Sound studios, Aircraft service and many parallel applications. Dependability, precision, exacting standards, rugged quality and variety of fittings—these are factors that have made CANNON CABLE CONNECTORS leaders in their field. Over 1,000 stock fittings are always available. Descriptive Bulletins afford valuable information and may assist you in solving your "plug" problems. When requesting Bulletin, please specify your requirements.

Cannon Plugs are pre-eminent in the fields of Sound, Aeronautics, Geophysical Research, Instrument Control on Ships and Laboratory Panels.

CANNON ELECTRIC DEVELOPMENT CO.

★ 420 West Avenue 33, Los Angeles, California
★ EASTERN SALES OFFICE, 220 Fifth Ave., New York, N.Y.

CANNON PLUGS



Powerful Sensitive Relays for AUTOMATIC CONTROL-KEYING-ANTENNA CHANGEOVER

• Specially Adapted for Aircraft Radio

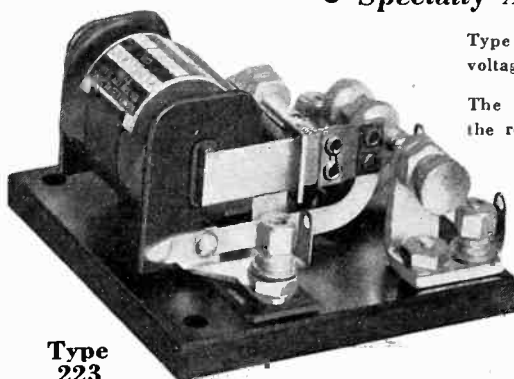

Type 223

Type 223 is particularly adapted for speed keying of high voltage, high frequency current.

The conditions encountered in aircraft radio demand that the relay be unaffected by position or vibration. The Korman Sensitive Relays have balanced armatures.

A mica-insulated balanced armature-contact arm assembly is provided. Full particulars in Bulletin 210.

Send us your specifications, we may have a relay suitable for your needs.

KURMAN ELECTRIC CO., INC.
241 Lafayette St. New York, N. Y.

Why Ponder . . . ?



Compact Co-ordinated Control

A complete, competent, control engineering staff will—without cost or obligation—solve your control problems. Since the beginning Guardian Engineers have specialized in building electrical controls for industry—constantly aware of and responsive to changing trends in every industry . . . your industry.

Everything from the simplest relay to complete packaged control can be designed, completely fabricated and tested at Guardian—delivered in complete packaged form, ready for mounting in your machine.

Ask Us To Make Specific Recommendations. Write for Catalog "E" Today!

GUARDIAN



ELECTRIC

1625 W. Walnut Street

Chicago, Illinois

Fluorescent Materials

IN ALL COLORS IN THE SPECTRUM FOR TELEVISION APPLICATION . . .

SILICATES and Tungstates, in all colors in the spectrum, are available for cathode ray tube applications.
 TUNGSTEN — MOLYBDENUM — KULGRID LEAD-IN WIRES
 Leading tube manufacturers are well acquainted with the life-long dependability and production accuracy of Callite Tungsten—Molybdenum and Kulgrid lead-in wires. Don't accept inferior substitutes. Depend on Callite quality products for maximum production efficiency.

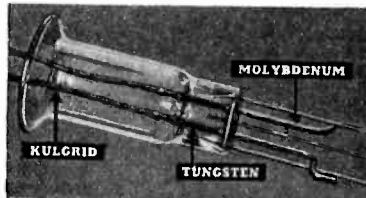

Call on Callite engineers for detailed information on fluorescent materials, lead-in wires and contact points.

CALLITE PRODUCTS DIVISION

EISLER ELECTRIC CORP. • 544 39th ST. • UNION CITY, N. J.

in reception have been announced by Consolidated Wire and Associated Corps., 514 So. Peoria St., Chicago. A coil, contained in a tube from which it is shielded, fits between the lead-in and the receiver. A spring within the unit assures positive contact at each end connection. These units offer an easy, inexpensive way to increase the efficiency of auto radio aerials.

Television Antennas

THREE TELEVISION antenna systems have been announced by RCA Manufacturing Co., Camden, N. J. No. 9871 is a double di-pole antenna for use where reflection or distortion are not

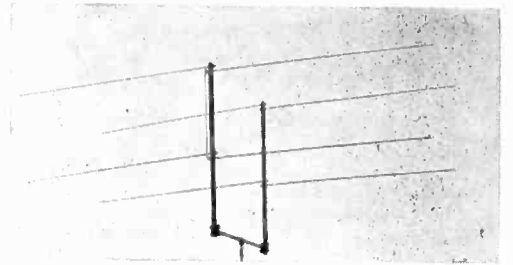

problems. It consists of four antenna rods, a wooden mounting pole and accessories for convenient location. List price is \$7.50. The combination of antenna No. 9871 and reflector No. 9872 is for use in locations where television signals travel over two paths as a result of reflection from some obstacle, thus causing double images and blurring. The list price of the reflector is \$13.75. The third system is the double V wire television antenna for use in locations where signal strength is good and reflection problems are not encountered. The list price is \$4.00.

Record Changer

ANOTHER NEW automatic record changer, Model RC-50, has been introduced by Garrard Sales Corp., 296 Broadway, New York. The model RC-50 will play eight records of either ten or twelve inch diameter in any sequence. A new non-slip spindle

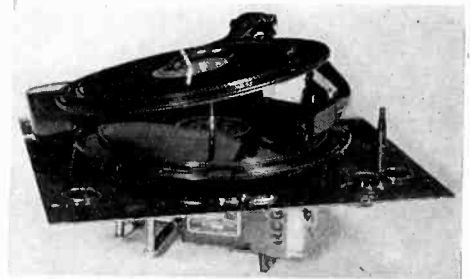

eliminates record slippage no matter how badly the records may be warped or chipped. Spring mounting hardware is furnished so that the unit floats free of the cabinet. Two units are available; the RC-50 which oper-



"DUCTER" LOW RESISTANCE TESTING SET

DIRECT POINTER READINGS
DOWN TO .000001 OHM

For rapid measurements of armature, field and transformer coils, soldered joints, fuses, switch and relay contacts, and other low resistances. Operates from battery. Requires no adjustment for battery voltage. Simply apply a pair of hand spikes and read the scale.

WRITE FOR BULLETIN 1440-E.

JAMES G. BIDDLE CO.
ELECTRICAL AND
SCIENTIFIC INSTRUMENTS
1211-13 ARCH ST. PHILADELPHIA, PA.



Model DN-50 DYNAMIC MICROPHONE

High in Efficiency.
Low in Price.

Model DN-50 Microphone incorporates Astatic's new Unitary Moving Coil System... a correctly designed magnetic structure with Alnico Magnet and carefully proportioned acoustic circuit. Equipped with tilting head, swivel base, plug connector and 25 ft. cable. **\$20**

Transformer Models \$22.50
See Jobber or Write for Literature

ASTATIC

**ASTATIC MICROPHONE
LABORATORY, INC.**

YOUNGSTOWN, OHIO

Licensed Under Brush Development Co. Patents

ates on 110 or 220 volts ac and uses a crystal pick-up, and the RC-51 an ac-dc model which operates on 110 or 220 volts and uses the Garrard high impedance, high output magnetic pick-up.

Portable Sound System

A PORTABLE AMPLIFIER (Model 458) which delivers 30 watts output and which operates on either a 115-volt line or a 6-volt battery is announced by Lafayette Radio Corp., 100 Sixth Ave., New York. The amplifier, phono



turntable and pick-up, and a six-volt motor-generator are built into an all-metal carrying case with a removable cover which provides storage space for records, cables, microphones, etc. The amplifier has ten tubes with 6Y7Gs in push-pull-parallel in the Class B final stage. The unit has two input channels for microphones and one for phono and a universal output channel. The frequency range is from 50 to 10,000 cps and the gain (measured with input impedance of 150,000 ohms) is 120 db for the low level inputs and 90 db for the phono input. The power consumption is 125 watts at 115 volts ac, or 15-25 amperes at six volts dc.

Transmitter

A TRANSMITTER to operate between 1.7 and 60 Mc is announced by Hallcrafters, Inc., 2611 Indiana Ave., Chicago. It has eight tubes including an 807 or RK39 in the power amplifier stage and has a power output of 25 watts. Each of the three channels is set up by the use of appropriate plug-in units and all circuits except the final tank circuit are pretuned to the desired operating frequencies. Shifting from one band to another therefore involves only the throwing of a switch and tuning the tank condenser by a single control. Normal operation is from the 115 volt ac line, but provision is made for operation from batteries or other dc source. The transmitter is contained in a steel cabinet 20 inches long, 15 inches deep and 9 inches high.

"Pincor"
Type "DA"
Converter



"Pincor"
Type "PS"
Dynamotor



A Complete Line For Every Purpose

Radio engineers have learned from experience that Pioneer Gen-E-Motor Corporation's dynamotors, gen-e-motors and converters provide the last word in dependable power supply units for air craft, police, marine and auto radios and public address systems. They are available in a wide range of capacities for every requirement. Designed and constructed to give maximum long life and service. Light weight and compact. For complete information fill out and mail coupon below.

PIONEER GEN-E-MOTOR CORP.
466 W. Superior St., Chicago

Export Address
25 WARREN ST.
NEW YORK, N. Y.



PIONEER GEN-E-MOTOR CORPORATION
Dept. R-41, 466 W. Superior Street, Chicago, Illinois
Please send me "Pincor" Silver Band Dynamotor
Catalog and Data Sheets.

Name
Address
City State
 Also send me Converter Catalog

Speaking of
Recording Equipment—
HAVE YOU SEEN
The New
PRESTO MODEL Y?

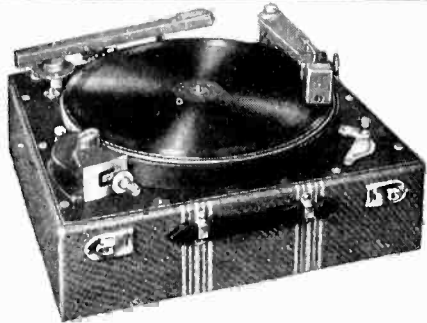

and have you noticed
these features?

- 1 New rubber-rimmed turntable, driven directly by the motor. Only two moving parts—no gears, no idler wheels, nothing to wear out.
- 2 Instant change 78 to 33 $\frac{1}{3}$ r.p.m.
- 3 Instant change outside-in to inside-out cut.
- 4 Makes starting and runout spiral grooves.
- 5 Makes eccentric trip groove at center of record.
- 6 High fidelity cutter, range 50 to 6500 c.p.s.
- 7 Cuts records up to 17 $\frac{1}{4}$ " size at 112 lines per inch.
- 8 Easily portable; weighs only 44 lbs.
- 9 List price \$350.00.



- 10 Combination amplifier-loudspeaker divides diagonally.
- 11 One side contains 10-watt amplifier with gain of 125 db. Uniform response 50 to 10,000 c.p.s. Equipped with two-microphone mixer, high and low frequency equalizers. Operates as recorder, playback or public address system.
- 12 Second section (not shown) contains 10" high quality speaker.
- 13 Weighs 47 lbs.
- 14 List price \$245.00.

The Presto Model Y recorder is recommended for use in broadcasting stations, schools or commercial recording studios. Send for booklet giving complete technical data.

PRESTO RECORDING CORPORATION
242 West 55th Street, New York, N. Y.

Insulators

IMPROVED FEEDER spreaders and insulators for radio transmission made of Lucite are now being manufactured by Caldwell Products Co., Mt. Vernon, N. Y. The spreaders, called No-Ty, in the standard two, four and six inch lengths, and in $\frac{3}{8}$ inch diameter, have a metal set-screw at each end, with the screw fitting into a tapped hole drilled in the plastic. Instead of a slot for a tie wire, the spreaders have a round hole running through the diameter of the rod at each end through which the feeder wire is run. The set-screw is perpendicular to the wire at this point.

Coupling Capacitor

A NEW LARGER TYPE CA carrier current coupling condenser has been announced by Cornell-Dubilier Electric Corp., South Plainfield, N. J. The fog



type petticoats give a large creepage distance between terminals. The capacitors are constructed with galvanized malleable iron mounting flanges so that they may be stacked for series, high voltage connection. New internal mechanical construction affords great tensile strength. The base and top are sealed so as to give leakproof service. The capacitor sections are designed for low resistance at high frequencies and very low 60 cycle stress. The individual units are now made up to 46,000 volts, but may be stacked to operate at any desired voltage.

Fuses

SLO-BLO FUSES which are designed to carry harmless inductive or capacitive surges and overloads for a reasonable period of time, but to blow before the danger point is reached are announced by Littelfuse Incorporated, 4238 Lincoln Ave., Chicago. They are dual purpose fuses having a simple fuse link and a resistor element which provides the heat inertia or time lag.

On severe overloads the fuse link melts as a conventional fuse, but on less severe, prolonged overloads the resistor heats up and melts the fusible alloy connecting it to the fuse link.

B Battery

A NEW B BATTERY called the Mini-Max is announced by National Carbon Co., 30 East 42nd St., New York. It weighs only two pounds but has a

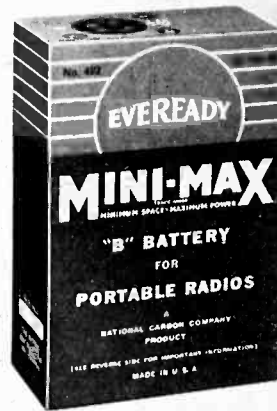

service life equal to that of the average battery twice its size. Model 482 is 3 $\frac{1}{2}$ by 1 $\frac{3}{4}$ by 5 $\frac{1}{8}$ inches and provides 45 volts for 200 to 300 hours in an average portable receiver. The name of the battery is derived from the idea of minimum space to give maximum power.

Coil Turrets

FOUR NEW BABY COIL turrets are announced by Barker & Williamson Co., Ardmore, Pa. They are designed for use as 5-band switching units in low-power transmitter and exciter stages. Each turret contains five B & W coils covering the range from ten to 160 meters and may be tuned in all types of service with any midjet condenser having an effective capacity of 100 μ f. The coils are mounted as an integral part of the switch by means of a stamped metal spider which maintains permanent coil alignment and a maximum of rigidity in the assembly. The turrets are all rated at 35 watts and are available in four types for different types of service.

Frequency Standard

A NEW 100-1000 kc oscillator standard, BL-2FS, was recently announced by Browning Laboratories, Inc., 750 Main St., Winchester, Mass. It consists of two stable E. C. circuits mounted, together with a band-switch, in a shielded can. Silver cap condensers are placed across each coil. Frequency adjustment is made by the use of brass plunger screws inserted in each coil. The frequency may be checked against Station WWV.

Frequency Modulation Receivers

THE FIRST FREQUENCY modulation receivers designed for public use have been announced by General Electric Co., Bridgeport, Conn. Model HM-136 has in addition to the band from 39 to 44 Mc for frequency modulated



signals, three bands for the reception of amplitude modulated signals. Provision is made to receive television audio signals and for phonograph records. This receiver has thirteen tubes and delivers 20 watts of audio power. Models HM-80 and HM-85 use identical chasses, but different cabinets. The tuning range of these models is 39 to 44 Mc. Provision is also made in these receivers for television audio signals and for phonograph records. Eight tubes are used in these sets which have a power output of five watts.

Molding Machine

A NEW COMPLETELY automatic molding machine for thermo-setting plastics is announced by F. J. Stokes Machine Co., Olney P. O., Philadelphia. It has a ten inch stroke and is rated at fifteen tons, but will produce moldings requiring up to eighteen tons pressure. It will mold parts up to four inches in height, six inches long and 19 inches of projected area. It has an adjustable bolster to reduce the length of ram travel and thus increase production rates on shallow work. Single cavity molds are used and the machine has a production rate of 10,000 or more pieces of work per week. The rate can be increased by the use of two or more molds in the same machine.

Insulated Tube Caps

A LINE OF INSULATED tube caps is announced by Alden Products Co., 715 Center St., Brockton, Mass. A large variety of styles is provided to fit various tube types. In some styles the insulating skirt fits well down



DIRECT READING FREQUENCY MONITOR

MODEL FD8 BY

Doolittle

FEATURES:

- Provides direct reading of frequency deviation
- Temperature controlled crystal chamber
- Monitors four frequencies

- Operates on any frequency—1500 to 50,000 KC
- Accuracy of the monitoring frequency is .002 per cent
- Three ranges of measurement—1000, 5000, and 10,000 cycles

For further details write

DOOLITTLE & FALKNOR, Inc. 7421 S. LOOMIS BLVD. CHICAGO, ILLINOIS



PERMANENT MAGNETS

ALL SHAPES — ALL SIZES
FOR ALL PURPOSES

Stamped, Formed, and Cast; Chrome, Tungsten, Cobalt and ALNICO** (cast or sintered) under G. E. license.

THOMAS & SKINNER
STEEL PRODUCTS COMPANY

1116 E. 23rd STREET INDIANAPOLIS, INDIANA

Laminations for Radio Transformers — Tools
Dies — Heat Treating — Stampings

38 YEARS EXPERIENCE

Note These Features of This New Webster Electric Crystal Pick-up!



Licensed under patents of the
Brush Development Company

Moisture-proofed crystal element... Frequency response range from 50 to 8500 cycles... Rubber cushioned arm assembly... Needle pressure of only 2.5 ounces... Convenient single hole mounting for motor boards from 1/16" to 1/2" thick... Write for technical details.

WEBSTER ELECTRIC COMPANY
RACINE, WISCONSIN, U.S.A. Est. 1909
Export Dept.: 100 Varick Street, New York City. Cable Address: "ARLAB" New York

Webster Electric

"Where Quality is a Responsibility and Fair Dealing an Obligation"

PRECISION PERFORMANCE

at a Popular Price!

RCP TEST INSTRUMENTS

Two things you want in test equipment: precision engineering, moderate cost. RCP's steadily climbing sales curve shows how seldom in instruments these two have been combined. Yes, RCP offers—accuracy, dependability and moderate cost. Proof? Check the instruments below. Remember, these are only three in RCP's complete line.

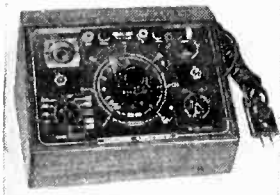

**RCP
ELECTRONIC
MULTITESTER
MODEL 660**

ONLY IN AN INSTRUMENT COSTING 2 to 4 times the price are found the same extraordinary ranges, the sensitivity and facilities for measuring large values offered by this vacuum tube volt-ohmmeter. Ranges up to 6000 volts D.C., and 1 billion ohms. Lowest reading 0.1 volt. Gets its unusual sensitivity from an input resistance of 200 megohms on all ranges except 6 volts, (forty million). Total of 12 ranges all on direct reading scales. Extreme operating simplicity and versatility makes the Model 660 ideal for production line as well as service application. Supplied complete in hand-rubbed sloping walnut case. **\$18.85** Net.

**RCP
UNIVERSAL
SUPER-
TESTER
MODEL 411**

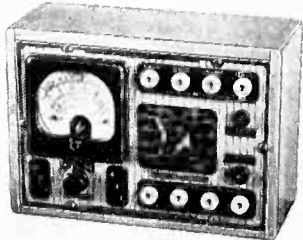

THE MOST COMPREHENSIVE tester ever devised to provide measurements of such accuracy in ranges never before available in small instruments. Features include: 5 stage AC-DC voltage range to 5000 volts. 3 stage AC-DC current range to 25 amps. DC milliamps 0/10/100. DC microamps 0/200. 3 stage ohmmeter range to 4,000,000 ohms. In natural hardwood case. Net **\$16.25**

**RCP
SIGNAL
GENERATOR
MODEL 702**

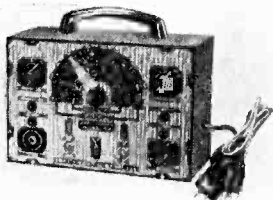

EVEN FINER PERFORMANCE than RCP's former signal generator, and that—costing 30% more—was an outstanding buy! Has all the latest improvements in circuit and mechanical design. Extremely wide all-wave coverage continuously variable from 95 Kilocycles to 100 Megacycles. Output may be modulated at will. 30% modulation at 400 cycles. sine wave from self-contained independent 400 cycle circuit. Can be used with outside sweep circuit and wobulator for all forms of oscillographic wave analysis. Attenuation in approximate microvolts by means of five step ladder attenuator. Attractive professional appearance. **\$22.95** AC operated. Net.

CATALOG No. 121 carrying complete story of the RCP Quality line of test equipment free on request.

RADIO CITY
PRODUCTS CO. INC.
88 PARK PLACE, N. Y. C.

over the side of the tube. The caps may be fitted with any of a large number of different types of wire. The clips are made of phosphor bronze, but special heat treated beryllium copper may be supplied. In those types designed for transmitting work, the wire is clamped to the clip because the high temperatures involved in normal operation would melt any solder joint. Also announced by this company is an interlock to remove the source of power when the back panel of equipment is removed.

I-f Coil

A NEW PERMEABILITY tuned i-f coil has been announced by Burlington Labora-

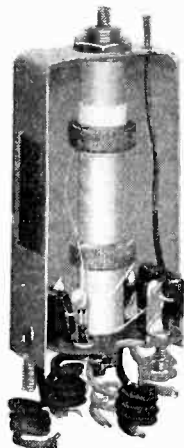

tories, Inc., 1617 North Damen Ave., Chicago. The new coil combines stabil-

ity with selectivity and gain. The coils are wound on bakelite tubing and can be adjusted from the top or bottom. The unit is compactly constructed in a shielded can 1½ inches by 3½ inches.

Transmitting Tube

A MODERNIZED VERSION of the old standard type 849 transmitting tube is announced by United Electronics Co., 42 Spring St., Newark, N. J. It is the type 949A tube. The new tube has an anode of especially processed graphite which reduces troubles from occluded gases. The dimensions and mounting facilities of the 949A are identical with those of the 849, but the characteristics are considerably improved. The power output of the new tube is 1200 watts as against 650 watts for the old tube. The domestic retail price is \$135.

Vibrators

A NEW LINE of vibrator power supplies is announced by Electronic Laboratories, Inc., 122 West New York St., Indianapolis, Ind. The new line contains conventional small vibrator supplies which will deliver 100 ma at 300 volts and heavy duty supplies capable of delivering 200 ma at 400 volts. They will operate on 110 volts a-c as well as the various d-c voltages and are designed to use either two type

STABILIZED A. C. VOLTAGE UP TO 25 KVA

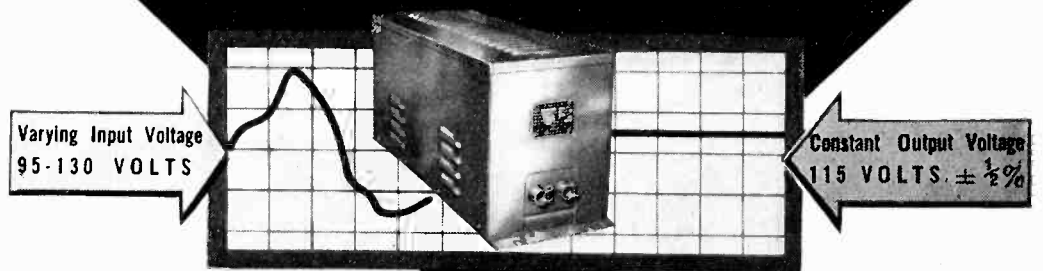

INSTANTANEOUS ACTION

NO MOVING PARTS

When a precision electrical device or a critical process is powered from an AC line, a Raytheon Voltage Stabilizer will permanently eliminate all of the detrimental effects caused by AC line voltage fluctuations. Made for all commercial voltages and frequencies, single or three phase.

Raytheon's twelve years of experience in successfully applying the Stabilizer to hundreds of perplexing voltage fluctuation problems is at your service. It will pay you to take advantage of our engineering skill.

Write for Bulletin DL48-71 JE describing Raytheon Stabilizers.

RAYTHEON MANUFACTURING CO.
100 Willow Street, WALTHAM, Massachusetts



ALDEN SERVICES

We specialize in problems of making any component needed

Small quantities or large

Of Bakelite, Metal, Wire or any combination. Components such as:

- Insulated Grid Caps
- High Voltage Rectifier Sockets
- Woven Wire Cables
- Dial Light Sockets
- Automotive Shielded Cables and Grounding Sockets
- Adapters for all circuits and all purposes
- Connectors of all kinds
- Several interesting new developments for television

Get your name on the mailing list for new interesting data sheet about to be released.

ALDEN PRODUCTS COMPANY
715 Center Street Brockton, Mass.

OZ4 tubes or one type 5T4 tube. The heavy duty units utilize the electronic converter type vibrator or tandem type vibrator which have approximately five to eight times the life of an ordinary auto radio type unit.

Microvolter

A CRYSTAL CONTROLLED Microvolter, Model 19X, with a self-contained vacuum tube voltmeter and power level meter is announced by The Hickok Electrical Instrument Co., 10514

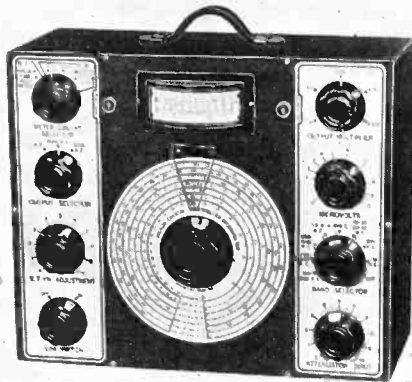

Dupont Ave., Cleveland, Ohio. It has a frequency range from 100 kc to 60 Mc over seven bands and is accurate to 0.01 per cent. The r-f output is directly calibrated from 0.5 to 100,000 microvolts on all ranges. The a-f output is calibrated from 0 to 1.0 volt.

AUTOMATIC TELEGRAPH DEVICE



Recently demonstrated at the Golden Gate Exposition was this automatic device for sending and receiving facsimile telegrams. A. E. Litter and Patricia are shown sending the first facsimile telegram on the machine

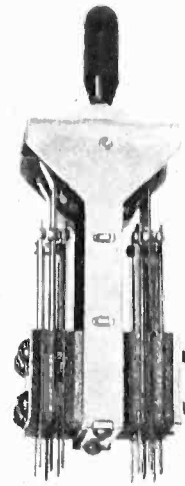

GENERAL CONTROL CAM LEVER SWITCH

Specifications of G C L Cam Lever Switch are as follows:

- Non-Corrosive—No Bounce
- 10 amps. 125 volts A C
- 2 amps. 125 volts D C
- Lock or non-lock features
- Assembly Possibilities Unlimited

A FEW OF OUR CUSTOMERS

These leading United States manufacturers have ordered and re-ordered G C L Cam Lever Switches.

- Bendix Radio Corp.
- The Bristol Company
- California Inst. of Tech.
- General Electric Company
- Westinghouse Electric & Mfg. Co.
- Ken-Rad Tube & Lamp Corp.
- Western Union Tel. Co.
- Idaho Power Company

We manufacture complete automatic control equipment for machinery and process equipment.

CONTACT ASSEMBLIES

Separate contact assemblies and contacts themselves available.

- Dimensions contact assembly 3 1/2 inches overall
- Dimensions between mounting centers 9/16 inches



GENERAL CONTROL COMPANY

Cambridge Mass.

- Please send me at no obligation:
- Full information on Cam Lever Switches or Contacts.
 - Full information on engineering service.
 - Quotations on problem details enclosed herewith.

Name

Position

Company

Address

Paste coupon on penny postcard and mail



for

SENSITIVITY

D.C. RELAYS

operating at one to fifty milliwatts to control A.C. loads of 50 to 1000 watts

A.F. RELAYS

actuated by telephonically applied sound to initiate control functions through other relays

ACOUSTIC SWITCHES

with sensitivity adjustable for desired response to sounds of high or low intensity.

Write for Data Sheet Number Seven listing new Sigma products including the type 3-U one milliwatt relay.

Sigma Instruments, Inc.

388 Trapelo Road
Belmont Massachusetts

"PRECISION" QUALITY at POPULAR PRICES

Examine any instrument INTERNALLY as well as externally. Note the PRECISION craftsmanship and the infinite care in construction and wiring. Every instrument is individually calibrated against laboratory standards. More than 40 models in PRECISION'S 1940 line.



SERIES 844 34 RANGE AC - DC VOLT - OHM - DECIBEL - MILLIAMMETER 6000 Volts, AC-DC; 10 Megohms; 12 Amperes

- SIX A.C. and D.C. VOLTAGE RANGES at 1000 ohms per volt: 0-12; 0-60; 0-300; 0-600; 0-1200; 0-6000 volts.
 - SIX D.C. CURRENT RANGES: 0-1.2; 0-12; 0-60; 0-300; 0-1200 MA; and 0-12 amperes.
 - FOUR RESISTANCE RANGES: 0-400; 0-100,000; 0-1 Meg.; and 0-10 Megs. Provisions for Mounting Ohmmeter Batteries (4½ and 45 volts) on inside of case.
 - SIX DECIBEL RANGES from -12 to +70 DB.
 - SIX OUTPUT RANGES: 0-12; 0-60; 0-300; 0-600; 1-1200; 0-6000 volts.
- 844-P—Walnut finished hardwood portable case, removable cover and tool compartment. Size 9 x 10 x 6.
Net Price (Less batteries and test leads)... **\$24.95**

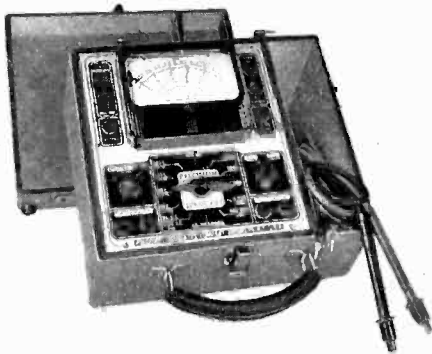

No. 852 SUPER SENSITIVE TESTER

39 Range AC-DC VOLT-OHM-DECIBEL-MILLIAMMETER including ranges of 5000 Volts AC-DC, 50 Microamperes, 10 Amperes and 40 Megohms. For television, radio, industrial and laboratory application.

20,000 OHMS per Volt D.C.

- SEVEN DC voltage ranges at 20,000 ohms per volt: 0-5; 0-10; 0-50; 0-150; 0-500; 0-1500; 0-5000 volts.
- SEVEN AC voltage ranges at 1000 ohms per volt: 0-2.5; 0-10; 0-50; 0-150; 0-500; 0-1500; 0-5000 volts.
- EIGHT DC current ranges: 0-50; 0-100 microamperes; 0-1; 0-10; 0-50; 0-150; 0-500 MA; 0-10 Amperes.
- THREE RESISTANCE RANGES: Low Ohms—0-4000 ohms (35 ohms center). Medium Ohms—0-400,000 ohms. High Ohms—0-40 megohms. All ohmmeter ranges powered by self-contained battery supply.
- SEVEN DECIBEL RANGES FROM -12 to +69 DB.
- SEVEN OUTPUT RANGES: 0-2.5; 0-10; 0-50; 0-150; 0-500; 0-1500; 0-5000 volts.
- METER: Large modern 4½" Precision square meter, cobalt magnet; accurately machined soft iron pole pieces; double jeweled D'Arsonval type; 50 microamperes full scale sensitivity.
- SHUNTS AND METALLIZED MULTIPLIERS BOTH OF 1% ACCURACY.

852P—Walnut finished hardwood portable case, removable cover and tool compartment. Size 9 x 10 x 6.
Net Price (Complete with batteries and high voltage test leads)..... **\$41.95**



PRECISION APPARATUS CO.
647 KENT AVE. BROOKLYN, NEW YORK
Export Division—458 Broadway, New York City, U.S.A.
Cable Address: Morhanex

British Patents

Luminescent Screens

No. 501,490. A fluorescent screen of calcium and/or strontium oxide activated by manganese is applied to the conductive substratum of a discharge tube by grinding a mixture of calcium and/or strontium carbonate and manganese carbonate or dioxide, spraying a thin layer of the ground material onto the substratum, and decomposing the carbonates by heating within the exhausted tube. High-frequency currents are used for heating the mixture. The mixture of carbonates is precipitated from a solution of the corresponding nitrates. Philips.

No. 501,624. Before application to the screen surface, luminescent material is mixed intimately with a small amount, e.g. ½—1 per cent, of phosphoric acid and enough liquid to form a paste and after drying and grinding, the resulting powder is treated to eliminate the coarser particles. The liquid may be water, e.g. by employing a 5 per cent solution of the phosphoric acid of the kind sold under the Registered Trade Mark "Analar." The drying is conducted for one hour at 200° C. and the sieve is of 240 mesh. Phosphoric acid may also be used as the binder. G.E. Co.

No. 501,707. Luminescent zinc sulphide or zinc-cadmium sulphide is surrounded during the heating step in its preparation by an inorganic salt mass which contains as the basic constituent zinc oxide and, if desired, Na₂O, and as the acid constituent B₂O₃ and/or P₂O₅, the composition satisfying conditions which define the relation between the mol. percentages of the constituents. The salt mass exercises a protective effect on the luminescent material and increases the luminous efficiency. In one example, a mixture of zinc oxide, sodium carbonate, boric acid and phosphoric acid is heated in a platinum basin for ½ to 1 hour to a temperature of 400—500° C. The sintered mass is pulverized and heated in a platinum crucible to 1100° C. The vitreous coagulated mass is then cooled, pulverized in a steel mortar and sieved. The powder is mixed with 5 grs. of a green-luminescent zinc sulphide preparation and heated to 900° C. for from 5—10 minutes, stirred and poured onto a cold plate. In the further examples either phosphoric acid, boric acid or sodium carbonate are omitted and different zinc sulphides or zinc cadmium sulphides are combined with the sintered salt masses. Potassium carbonate may be used in place of sodium carbonate. The luminescent mass so obtained may be made into advertising and decorative articles, or in gas discharge tubes in which it is melted onto the glass wall of the tube or an auxiliary tube. Philips.

FERROCART

IRON CORES

Secure IMPROVED PERFORMANCES. Cores and prices to meet every need—YOU CANNOT AFFORD TO USE ANYTHING INFERIOR.

Proven the most dependable and uniform (electrically and physically) for permeability tuning and push-button remote tuning—wave-traps, I F transformers and antenna coils—sensitive television circuits, etc.

Our engineers with PRACTICAL KNOWLEDGE collaborate in securing optimum original designs in your circuits suitable for commercial manufacture.

FERROCART CORPORATION OF AMERICA

(Devoted exclusively to engineering and production of magnetic iron cores)

Laboratories and Works
Hastings-on-Hudson, N. Y. U. S. A.
Cable Address "HARAFORD"
Hastings-on-Hudson, N. Y., U.S.A.

CO-X FLEXIBLE COAXIAL CABLE by B.I.W.

CO-X is low-loss, flexible coaxial cable, first of its type in the U. S., employing specially designed beads to provide 80% of air insulation. Made in standard sizes—¼", ½", and ¾" diam.—weatherproof covering optional. Ideal for television, short wave, aircraft, marine and auto antenna. Folders on request.

Special Types to Order

CO-X also is made to order to your specifications as to electrical characteristics and definite length, with pigtail leads for connections. Send us your problem—no obligation.

Other B.I.W. Products for Electronic Industry

High-voltage flexible cables
Heat-resisting wire
Interconnecting assemblies
Multi-conductor instrument cable
Flexible instrument wire
High Q hookup wire • Shielding
Resistance drop cords
Power supply cables

BOSTON INSULATED WIRE and CABLE COMPANY

Boston, Massachusetts Established 1905

No. 501,726. In electric discharge tubes having fluorescent screens as described in the parent Specification comprising a transparent support and a fluorescent material having a layer of metal with a melting point greater than 1800° C. on the fluorescent material or between this and the support, the metal employed is rhodium. The rhodium layer has the advantage that it does not readily oxidize. Standard Telephones.

No. 501,741. The luminescent properties of materials which have been impaired by fine grinding are improved by immersion in an easily volatilized acid solution, and thereafter drying so as to remove the solution. Screens so treated are more durable under electron bombardment. The concentration of the solution, time of immersion, &c. are determined empirically. The particles are ground small enough to pass through a screen of 200 to 400 mesh per inch. Synthetic willemite (Zn_2SiO_4 , Mn), cadmium phosphate, zinc carbonate, sulphate, or sulphide, uranyl fluoride, and calcium sulphide are mentioned as luminescent materials; and for removal of the surface layer, solutions of carbonic, nitric, hydrochloric, phosphoric, or oxalic acid, and hydrogen sulphide. Material so treated may be applied to a support as by spraying, or with a brush, or by settling from air or liquid suspension; and screens so formed may be used with X-ray apparatus, electron microscopes, image multipliers, or cathode-ray tubes. A method of forming a screen on a cathode-ray tube is described in which the particles are applied by settling from a suspension in an acid solution, so that the particles are treated at the same time as they are applied.

The Specification states also that an alkaline solution may be used for removing the deleterious surface layer, for example ammonium hydroxide, carbonate, or sulphide, tetramethylammonium hydroxide, and ethyl or other amine. This subject-matter does not appear in the Specification as accepted. Marconi.

No. 502,919. A luminescent screen is manufactured by treating luminiscent zinc sulphide and/or zinc-cadmium sulphide with a substantially colourless solution of an alkaline silicate and drying the said solution so that the residue of the dried solution is intimately mixed with at least the superficial layer of the luminescent material. In one process, the finely divided material is dusted on to cardboard or glass which has been well wetted with aqueous potassium silicate solution of specific gravity about 1.3, the water being allowed to evaporate. In the second process, the material is dusted on to a layer of organic varnish and afterwards painted with the aqueous solution of potassium silicate. The powdered material may also be suspended in the potassium silicate solution and applied to the support. Self-supporting blocks may also be made by drying

INSIDE OR OUT!

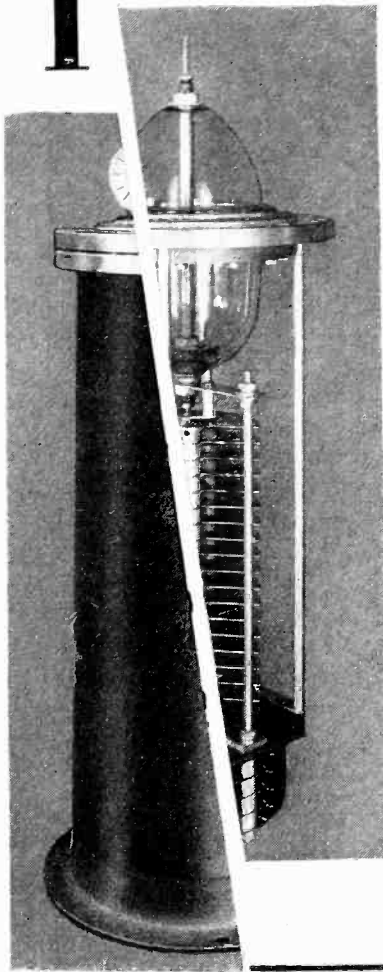

Johnson Pressure Condensers will bear the closest scrutiny—fill the most exacting requirements.

For into them has gone only the finest of materials, each chosen for its fitness for the part it plays; in their design, care and experience are evident throughout; these combined with skillful workmanship and rigid inspection assure years of reliable operation.

Shells are drawn in one piece from heavy steel, without a seam, weld, or joint at any point. (A mounting flange is, of course, arc welded externally.) The head also is steel, assuring freedom from porosity not possible with castings. Both head and shell are heavily copper plated. Only three gaskets are under gas pressure, and these are Neoprene. Pyrex and Mycalex only are used for insulation.

The unit illustrated is partly fixed, partly variable, may also be made all fixed or all variable to give you exactly the rating you need with space and cost both a minimum. Variable condensers are adjustable while operating, through a gear housing located at the top.

Find out more about these condensers and other Johnson products, such as co-axial cables, antenna coupling and phasing equipment, etc., by writing for catalog 301D.



E. F. JOHNSON CO.

WASECA, MINNESOTA

EXHIBIT 25-WARDEN ST., NEW YORK, N. Y.

"MANUFACTURERS OF RADIO TRANSMITTING EQUIPMENT"

built by
old world
craftsmen

GARRARD

AUTOMATIC RECORD
PLAYING EQUIPMENT

FOR FREE CATALOG AND NEW PROFIT PLAN WRITE TO
DEPT. 6219
GARRARD SALES CORP.
296 BROADWAY, N. Y.

Direct Reading "Leakage per Mf." Scale



Rejection Calibrated to U. S. Navy Specs.

Model 230 A-C Bridge eliminates time wasted in calculating measured leakage per mf. In addition, the voltage method of determining leakage avoids hazard of placing a milliammeter in high-voltage circuits. Applies up to 550 polarizing volts. Leakage or insulation-resistance tests are performed simultaneously with capacity measurement. No switch resetting or flash counting. Range—2 mmf.-200 mf., 2 ohms-20 megs. Leak.-and-Ins. Res.—0-2500 megs. Elect. P. F.—0-50%. Paper P. F.—0-.5%. Trans. Turns Ratios —.01-100. Write for complete data. \$37.50.

The CLOUGH-BRENGLE CO., 5501 Broadway, CHICAGO, ILL.

THE STANDARDS • FERRIS INSTRUMENTS

Signal Generators • Radio Noise Meter • 16C Precision Standard

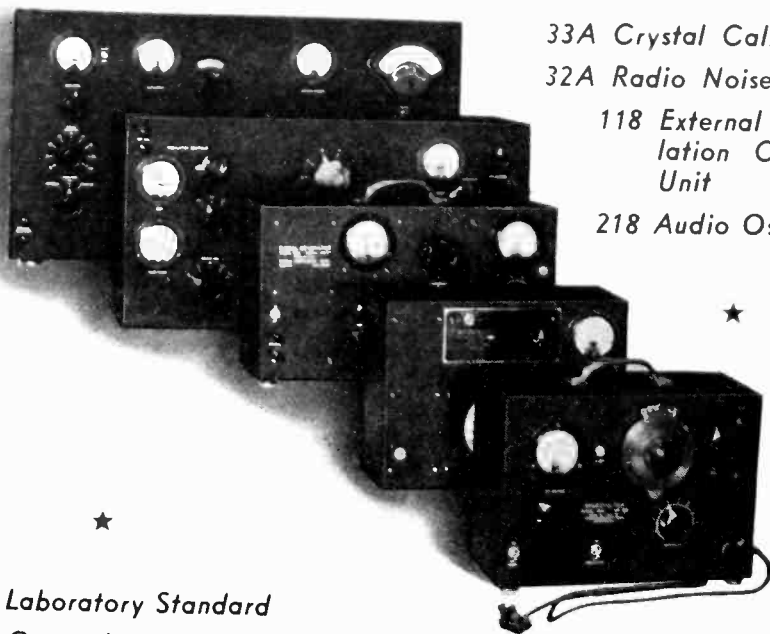

33A Crystal Calibrator
32A Radio Noise Meter
118 External Modulation Coupling Unit
218 Audio Oscillator

14C Laboratory Standard
22A General Purpose
20A1 Production Testing
18B Ultra High Frequency

Write for bulletins for complete details

FERRIS INSTRUMENT CORPORATION

BOONTON, NEW JERSEY



Frequency Measuring Service



Many stations find this exact measuring service of great value for routine observation of transmitter performance and for accurately calibrating their own monitors.

MEASUREMENTS WHEN YOU NEED THEM MOST
at any hour every day in the year

R.C.A. COMMUNICATIONS, Inc.

Commercial Dept.

A RADIO CORPORATION OF AMERICA SERVICE

66 BROAD STREET

NEW YORK, N. Y.

McGraw-Hill

DIRECT MAIL LISTS



As business paper publishers for over fifty years, McGraw-Hill is uniquely equipped to offer complete, authoritative direct mail coverage of Industry's major markets. Extreme accuracy is maintained (guaranteed to 98%) and through careful analysis of markets, complete classification of companies and personnel, etc., the widest possible selections are available. Send for handy reference folder, "Hundreds of Thousands of Reasons Why" which describes how McGraw-Hill Lists are built and maintained.

What Fields Do You Want to Reach?

Aviation
Bus & Electric Railways
Civil Engineering and Construction
Administrative Executives
Electrical Dealers & Wholesalers
Mill Supply Houses
Power Services
Product Engineering & Design
Production and Maintenance
Radio Dealers & Wholesalers
Radio Engineering & Design

For further details, selections from above basic classifications, counts, prices, etc., or estimates on special lists . . . ask any representative or write to

DIRECT MAIL DIVISION
McGraw-Hill PUBLISHING CO.
330 W. 42nd STREET NEW YORK, N. Y.

Complete Lists Covering Industry's Major Markets

a paste of the powdered material and potassium silicate solution. G.E. Co.

No. 503,082. An electric incandescent lamp with a metal filament has a bulb of transparent or translucent material which is provided with a coating of luminescent material adapted to be excited by radiations from the filament of not less than 3,200 Angstrom units to transform these radiations into visible radiations. The material of the bulb determines whether the luminescent material is applied to the inside or outside thereof, e.g. if the bulb is opaque to ultra-violet radiations the luminescent material is applied to the inside surface. In the case of a quartz bulb the luminescent material may be applied to the inside or outside, or both inside and outside. The luminescent effect is increased if the size of the bulb is greater than that used for ordinary nitrogen-argon filled lamps of the same wattage, the diameter of the bulb being about 1½ to 2 times the diameter of the ordinary lamp. Siemens.

No. 503,616. The envelope of an electric discharge tube is provided with a coating of particles of luminescent material bonded to the surface by a material including an alkaline silicate and the coating is then treated with an ammonium salt, preferably ammonium chloride. The luminescent material may comprise sharp edged particles and is preferably sufficiently fine to pass through a 200 mesh sieve. The material may be applied by coating the interior of the envelope with the bonding medium and applying the material thereto or by applying an emulsion of particles and bonding medium to the envelope, the latter being subsequently heated. The emulsion may be applied by spraying or centrifugal action. In examples: (1) infusorial or diatomaceous earth is mixed with zinc oxide and a manganese salt, as activator, ground, heated to 1000—1250° C., crushed, and sieved. The envelope, which may be clear or frosted internally, is coated internally with a solution of an alkaline silicate to which alkaline borates or tungstates may be added and the powdered material sprayed or blown thereon. The tubes are then allowed to dry and baked; (2) material prepared as above is mixed with the liquid bonding material and sprayed on the tube; and (3) the emulsion as prepared above is applied to the tube by centrifugal action. In all cases the coating is treated after baking with a hot concentrated solution of ammonium chloride. The tubes may be used for gas discharges, e.g. by using a filling of helium, neon, or argon and mercury. In place of manganese salts, the salts of cerium, vanadium or uranium may be used as activators. C. A. Laise.

No. 503,769. In preparing a luminescent powder, calcium sulphide and/or its oxidation products is, or are, subjected to a succession of alternate oxidation and reduction processes. A

New

The Library now comprises a revised selection of books culled from leading McGraw-Hill publications in the radio field.



McGraw-Hill RADIO ENGINEERING LIBRARY

— especially selected by radio specialists of McGraw-Hill publications

— to give most complete, dependable coverage of facts needed by all whose fields are grounded on radio fundamentals.

— available at a special price and terms

These books cover circuit phenomena, tube theory, networks, measurements, and other subjects—give specialized treatment of all fields of practical design and application. They are books of recognized position in the literature—books you will refer to and be referred to often. If you are a researcher or experimenter—if your interest in radio is deep-set and based on a real desire to go further in this field—you want these books for the help they give in hundreds of problems throughout the whole field of radio engineering.

5 volumes 3319 pages, 2298 illustrations

1. Eastman's FUNDAMENTALS OF VACUUM TUBES
2. Terman's RADIO ENGINEERING
3. Everitt's COMMUNICATION ENGINEERING
4. Hund's HIGH-FREQUENCY MEASUREMENTS
5. Henney's RADIO ENGINEERING HANDBOOK

Special Low Price and Easy Terms

Bought singly, the five volumes comprising this library would cost you \$24.50. Under this offer you save \$2.50 and, in addition, have the privilege of paying in easy installments beginning with \$2.50, 10 days after receipt of the books, and \$3.00 monthly thereafter. Already these books are recognized as standard works that you are bound to require sooner or later. Take advantage of these convenient terms to add them to your library now.

SEND THIS ON APPROVAL COUPON

McGraw-Hill Book Co., Inc.
330 W. 42nd St., New York, N. Y.

Send me the McGraw-Hill Radio Engineering Library 5 vols., for 10 days' examination on approval. In 10 days I will send \$2.50, plus few cents postage, and \$3.00 monthly till \$23.50 is paid, or return books postpaid. (We pay postage on orders accompanied by remittance of first installment.)

Name

Address

City and State

Position

Company L 9-39

(Books sent on approval in U. S. and Canada only.)

solid solution of calcium sulphide and calcium sulphate is obtained by igniting a mixture of calcium oxide, sulphur, an activator such as a copper salt, an alkali sulphite, a carbohydrate such as cane sugar, and, if necessary, calcium sulphate or by heating the same mixture to 900° C. in an atmosphere of hydrogen. The oxidation of the solid solution so formed is achieved by heating it in an oxidizing atmosphere or with an oxidizing compound such as potassium nitrate. The flux may be potassium metabisulphite, sodium sulphite or sodium thiosulphate and the activator salt, copper sulphate. Zinc sulphide and magnesium chloride may be added to the powder to increase the luminescent efficiency. The final mass is heated in air at 600° C. although the actual process at which the reactions are stopped is such that the quantity of calcium sulphide shall not be greater than the quantity of calcium sulphate. The final product is powdered and either blown onto an adhesive on the surface of the screen, or mixed with a liquid adhesive and applied to the screen. Siemens.

No. 504,354. An electrical gas-discharge device incorporates luminescent magnesium-cadmium tungstate excited by the discharge. Discoloration and loss of efficiency of the tungstate can be prevented by mixing the tungstate with free magnesium oxide or free cadmium oxide or both. In one method of preparing the luminescent material, a mixture of 1 mol. CdO and 2 mols. WO₃ is heated to 1000° C. for one hour in an oxidizing atmosphere and is then ground and mixed with 1.1 mol. MgO and heated to 1150° C. for 1 hour or longer until coloration is absent. The product is then ground with 0.1 mol. MgO and is not subsequently heated to any temperature approaching 1000° C. so that the added MgO remains free. In another method of preparing the luminescent material 0.1 mol. of CdO in the form of a solution of Cd(NO₃)₂ or CdSO₄ is added to MgWO₄ prepared by the method described in Specification 469,732 from a mixture of 1 mol. MgO and 1 mol. WO₃. The mixture is dried at 200° C., reground and heated in air at 1150° C. for 1 hour. A small amount of lead may be added as described in Specification 469,732. The magnesium-cadmium tungstate is preferably within the envelope in the case of a low-pressure mercury discharge. The electrodes may be cold or thermionic. In the case of a high-pressure mercury discharge, the tungstate is outside the envelope and much cooler than the envelope which is of quartz or other material whose transparency to ultra-violet light resembles quartz. The tungstate may be associated with zinc-beryllium silicate or the chlorophosphate described in Specification 495,706, which provide red light in which the mercury spectrum is deficient. The discharge may be through neon or a mixture of neon with a small amount of heavier rare gases;

TYPE 892 SIX POSITION BAND SWITCH

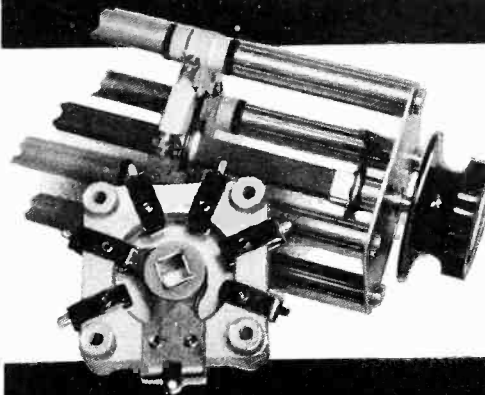

- Will Handle 1 kw Power
- Versatile Application
- Nickel Silver Contacts
- Alsimag Insulation
- Low Loss—Reliable
- Rating at 1 mc:
15 Amps. 4000 Volts

WRITE FOR DATA



LEACH (LR) RELAYS POSITIVE PROTECTION

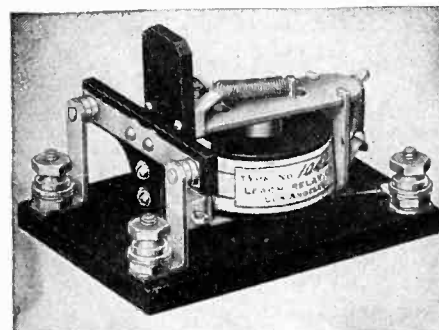

For Your Power Tubes. These light duty overload trip relays have a wide field of use as safety devices on electronic apparatus. Operation is unusually dependable. Scores of nationally known concerns rely on Leach Relays for protection.

Leach Relay Company

5915 Avalon Boulevard,
Los Angeles, Calif.

**SEND
COUPON**

Leach Relay Co., 5915 Avalon Boulevard, Los Angeles, Cal.
Please send me your catalog.

Name Company Address City

SEARCHLIGHT SECTION

EMPLOYMENT : BUSINESS : OPPORTUNITIES : EQUIPMENT — USED or RESALE

UNDISPLAYED RATE:

10 cents a word, minimum charge \$2.00.

Position Wanted: (full or part-time salaried employment only), ½ the above rates, payable in advance.

Proposals, 40 cents a line an insertion.

Copy for new advertisements must be received by September 29th for the October Issue

INFORMATION:

Box Numbers in care of our New York, Chicago, or San Francisco offices count 10 words additional in undisplayed ads. Replies forwarded without extra charge.

Discount of 10% if full payment is made in advance for four consecutive insertions of undisplayed ads (not including proposals).

DISPLAYED—RATE PER INCH:

The advertising rate is \$6.00 per inch for all advertising appearing on other than a contract basis. Contract rates quoted on request.

An advertising inch is measured ¾" vertically on one column, 3 columns—30 inches—to a page.

POSITIONS VACANT

PRODUCTION MANAGER. Must be familiar with all modern shop methods, preferably one having served as practical machinist in manufacture and assembly of small parts. Must be capable of managing small shop producing switches, relays and specially designed and constructed electrical parts. Radio experience desirable. Actual service with manufacturer of equipment over a period of approximately ten years considered necessary to properly fill this position which is permanent. P-214, Electronics, 330 W. 42nd St., New York, N. Y.

POSITIONS WANTED

RADIO SCHOOL GRADUATE, age thirty, telegraph and telephone licenses, desires connection with either Broadcast or other service. Copy on mill. Ten years amateur operating. Go anywhere. Edward Dodge, Box 44, Manchester, Mass.

RADIO ENGINEER, now employed by Latin American radio manufacturer, wants change for the better. Speaks Spanish. Would like employment as practical field engineer or sales engineer. Free to go anywhere. Experienced, all types sound equipment, radio receivers, communications, recording equipment. Several years experience in various branches of the industry in the U. S. American, single, age 26. PW-215, Electronics, 330 W. 42nd St., New York, N. Y.

RADIO ENGINEER, age 35—5 years at amplifier and speaker design. Qualifications necessary for position as Chief Engineer, possess sales ability. L. J. Fox, 605 Main St., Buffalo, N. Y.

TECHNICALLY TRAINED young man desires the opportunity to become an asset to your company in the radio, facsimile, or telephone industry. Can offer you telephone equipment installation, photography experience, and ambition. Radio Engineering degree 1937. PW-216, Electronics, 520 N. Michigan Ave., Chicago, Ill.

EXPERIENCED RESEARCH and Development Technician and Radio Field Service Engineer, Age 32, single, B.S. degree Elec. Engr., First Class Radiotelephone License, offers services to Radio or Electrical Company as Communication, Development and Research or Service Engineer. Will travel. PW-217, Electronics, 330 W. 42nd St., New York, N. Y.

FOR SALE

Complete 100% Modulated 2 KW Transmitter including Oven for 4 crystals, microphone to antenna equipment, 10 KW 60 cycle 115 V Generator, Howard 438 receiver. Will sell part or whole equipment cheap. Electronic Transformer Co., 135 Liberty St., New York, Rector 2-9788.

Radio—Coil—Factory, fully equipped for sale. FS-218, Electronics, 330 W. 42nd St., New York, N. Y.

WANTED

ANYTHING within reason that is wanted in the field served by Electronics can be quickly located through bringing it to the attention of thousands of men whose interest is assured because this is the business paper they read.

Don't Forget the Box Number

WHEN answering the classified advertisements in this magazine, don't forget to put the box number on your envelope. It's our only means of identifying the advertisement you are answering.



E. H. RIETZKE

PRES. OF CREI

Are You Trying to
KEEP or IMPROVE Your Job

Insure Your Future with C.R.E.I. Home-Study Training in Practical RADIO & TELEVISION ENGINEERING

Plenty of "pretty good" radiomen, but new developments in radio and television have put a real value on men with ability. CREI technical training can help you improve your knowledge and prepare for the big jobs and big salaries that go with them. Writing for complete details will not put you under any obligation.

Just Off the Press

New 48-page illustrated booklet "A Tested Plan for a Future in Radio and Television". Write for your copy today.



CAPITOL RADIO ENGINEERING INSTITUTE

DEPT. E-9, 3224-16TH ST. N.W., WASH., D. C.

IF IT'S RADIO

WE HAVE IT!

We carry a tremendous stock of radio equipment for broadcast stations, engineers, laboratories and industrial companies. If you're ever in a hurry . . . just call, write or wire to Sun Radio.

Ask for new catalog

ATTENTION ENGINEERS!

While in New York we invite you to drop in and look around. You will see the latest in radio apparatus.



3-STAGE HIGH VACUUM PUMP

G.E. Type York Model
Original Cost \$350.00
Now selling for \$45.00
Good running condition

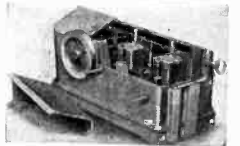

EISLER ENGINEERING CO.
751 So. 13 St. (near Avon Ave.) . . . Newark, N. J.

HIGH GRADE USED

ELECTRON TUBE MACHINERY

Huge Stock of Every Type and Variety

KAHLE ENGINEERING CORPORATION
Specialists in Equipment for the Manufacture of Neon Tubes, Radio Tubes, Incandescent Lamps, Photo Cells, X-ray Tubes, etc.

900 DeMott St., North Bergen, N. J.

DEPENDABLE

Used

ELECTRONIC TUBE EQUIPMENT

A complete line of used equipment for the manufacture of Radio Tubes, Neon Tubes, Incandescent Lamps, etc.

Write for Bulletin showing savings from 25 to 75%

EISLER ELECTRIC CORP.
534 39th Street, Union City, N. J.

DUMONT OSCILLOGRAPH

Used only a few times. Type 158—Unit 144—5" screen, complete with Electronic switch.

A real bargain

Elsbert Manufacturing Co., Inc.
353 West Grand Avenue, Chicago, Illinois

THESE ADVERTISEMENTS

constitute a comprehensive group of "live" opportunities in the industry served by this paper.

Each announcement represents a current Want of a concern or individual in the industry with some element of profit in each for whoever can fulfill the need. Some have money-saving possibilities, others are opportunities for more business; many are employment opportunities while still others offer chances to buy going businesses, plants, property, etc.

"Searchlight" advertisements are constantly changing. New opportunities find their way into this great Want medium each issue. Regular consultation of the "Searchlight" pages should be as important to the careful reader as reading editorial articles of his particular liking. One is news of the industry, the other, the NEWS OF OPPORTUNITIES being offered in the industry.

For Every Business Want

"Think SEARCHLIGHT First"

DRAKE



WORLD'S LARGEST EXCLUSIVE MANUFACTURERS

Dial Jewel
PILOT LIGHT ASSEMBLIES

DRAKE Pilot Light Assemblies are widely known for their dependability. Leading engineers and manufacturers of radios, airplane instrument panels, and electrical appliances specify DRAKE products exclusively. Extremely efficient large scale production coupled with finest materials and thorough inspection assures uniform quality and moderate cost. Standard units are available in a great variety of styles and sizes. Special designs can be developed for any need. Write today for samples and prices, or ask for the cooperation of our engineers on your pilot light problems.

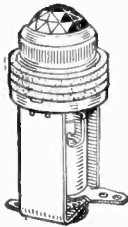

SEND FOR FREE CATALOG

DRAKE MANUFACTURING CO.
1713 W. HUBBARD ST. • CHICAGO, U. S. A.

PLUGS — SOCKETS
TERMINAL PANELS, ETC.



ILLUSTRATED
PLUG: P-6-CCT—SOCKET: S-6-AB

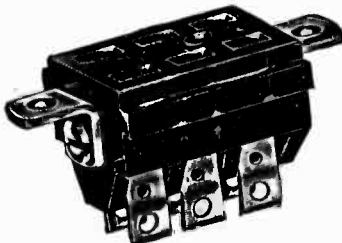

HUNDREDS OF STANDARD ITEMS OR SPECIALS TO YOUR BLUE-PRINTS.

WRITE FOR BULLETINS.

HOWARD B. JONES
2300 Wabansia Avenue
CHICAGO ILL.

the magnesium-cadmium tungstate may then be used instead of calcium tungstate. G.E. Co.

Patent Suits

1,507,016, L. De Forest, Radiosignaling system; 1,507,017, same, Wireless telegraph and telephone system, D. C., S. D. Calif., C. Div., Doc. Eq.-1332-RJ, *Western Electric Co., Inc., et al v. Bristow & Co. et al.* Consent decree holding patents valid and infringed Feb. 28, 1938. Doc. 141 C. Civ., *Western Electric Co., Inc., et al v. Alexander Hirsch (Radio Television Supply Co.)*. Decree in favor of plaintiffs, injunction Apr. 7, 1939.

1,617,240, R. A. Fessenden, Methods for wireless directive signaling; 1,617,242, same, Wireless transmission and reception, C. C. A., 3d Cir., Doc. 6850, *H. M. Fessenden v. R. C. A.* Lower court affirmed Apr. 13, 1939.

1,800,719, S. S. Cramer, Electrical condenser, D. C., S. D. N. Y., Doc. E 86-136, *Condenser Development Corp. v. Davega-City Radio, Inc.* Interlocutory decree favor of plaintiff, patent valid and infringed; injunction. (Notice Dec. 8, 1937.)

2,002,236, R. I. Wilcox, Automatic phonograph; 1,362,972, R. E. Utley, Phonograph, D. C., N. D. Ill., *Rudolph Wurlitzer Manufacturing Co. v. Rock-Ola Manufacturing Co.* Dismissed without prejudice Dec. 5, 1938.

1,887,380, W. J. Polydoroff, Process and apparatus for standardizing magnetic cores; 1,940,228, same, Radio amplifying circuits; 1,978,568, Crossley & Neighbors, High frequency inductance; 1,978,599, same, Variable inductance device; 1,978,600, same, Permeability-tuned resonant circuit; 1,982,689, same, Magnetic core material; 1,982,690, same, Selective radio circuit (suit for declaratory judgment), D. C., N. D. Ill., E. Div., Doc. 14438, *Ferrocarril Corp. of America v. V. S. Johnson et al.* Claim 38 of 1,982,690 held valid and infringed; claim 5 of 1,978,568, and claims 1 to 4 inclusive, 58, 74, 75, and 76 of 1,982,689 held invalid; 1,887,380, 1,940,228, 1,978,599, and 1,978,600 held not infringed. Counterclaim dismissed as to claim 5 of 1,978,568, and claims 1 to 4, 58, 74, 75, 76 of 1,982,689, and sustained as to claim 38 of 1,982,690, Aug. 7, 1936. Mandate of C. C. A. reversing decree of district court as to finding of validity and infringement of 1,982,690 Dec. 9, 1938. Decree of district court entered Dec. 13, 1938, pursuant to mandate.

1,978,568, Crossley & Neighbors, High frequency inductance; 1,982,690, W. J. Polydoroff, Selective radio circuit, D. C., N. D. Ill., E. Div., Doc. 14342, *Johnson Laboratories, Inc. v. Meissner Mfg. Co. et al.* Claim 5 of 1,978,568 held invalid; claim 38 of 1,982,690 held valid Aug. 7, 1936. Mandate of C. C. A. reversed decree of district court in so far as it found 1,982,690 valid; affirmed in other particulars Sept. 9, 1938. Order of district court dismissed bill pursuant to mandate Dec. 13, 1938.

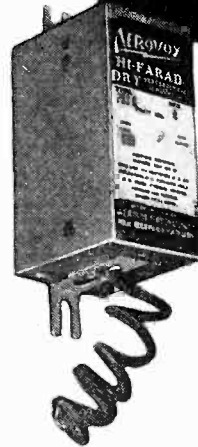

**Individually
Tested
Condensers**

There are no class distinctions among AEROVOX condensers when it comes to routine factory inspection and test. The ten-dollar X-mitting condenser and the ten-cent by-pass tubular are treated alike in safeguarding the good name of AEROVOX.

With an experience second to none in mass-production of quality condensers, AEROVOX still prefers to test each unit individually. Only in this way can your servicing and assemblies be insured against condenser gambles.

Ask for CATALOG...

A new edition is now ready. Ask your local jobber for a copy. Or write us direct—for the new catalog and a sample issue of our monthly "Research Worker".

AEROVOX
CORPORATION
NEW BEDFORD, MASS.
IN CANADA: AEROVOX CANADA, Limited Hamilton, Ont.

CONTACTS

FOR THE FIELD OF ELECTRONICS

EICOR DYNAMOTORS
for Aircraft, Police, Marine Radio

Rotary Converters
to change D.C. to A.C.

Utilite Plant
generate A.C. or D.C.

Write for Data

★ **EICOR INC.** ★
517 S. Laflin St., Chicago, U.S.A.

B-L RECTIFIERS

CHANGE AC TO DC WITHOUT MOVING PARTS, GLASS BULBS, LIQUIDS, OR SPARKING CONTACTS.

DRY—DURABLE
COMPACT—ECONOMICAL
SPECIAL RECTIFIERS AND COMPLETE ASSEMBLIES

THE BENWOOD LINZE CO.
ST. LOUIS, MO.
ELECTRICAL RECTIFIERS
MANUFACTURERS ENGINEERS

We manufacture a complete line of equipment

SPOT WELDERS, electric, from ¼ to 500 KVA
TRANSFORMERS, special and standard types
INCANDESCENT LAMP manufacturing equipment
RADIO TUBES, ex-ray, cathode ray, photo cells
ELECTRONIC EQUIPMENT, vacuum pumps, etc.
TUNGSTEN SLUGS, rod and wire manufacturing equipment
GENERAL GLASS working machines and burners
COLLEGE GLASS working units for students and laboratory

Please reply Attention: Chas. Eisler, President

EISLER ENGINEERING COMPANY
751 So. 13th St. (near Avon Ave.) Newark, New Jersey

VACUUM TUBES AND ELECTRONIC DEVICES

Industrial control and circuit problems. Design, Development and Construction of tubes and circuits.

VACUTRON, INC.
20 West 22 St. New York, N. Y.

MICROMETER FREQUENCY METER for checking transmitters, from 1.5 to 56 mc., within 0.01 per cent.

LAMPKIN LABORATORIES
— Bradenton, Fla., U. S. A.—

FINE RIBBONS
of Tungsten, Molybdenum and Special Alloys
To your specifications

H. CROSS
15 BEEKMAN ST. NEW YORK

ACTONE Shadowgraphed Needles

give true reproduction because they form-fit record grooves. Protect expensive recordings. Use Actone shadowgraphed perfect point needles for all reproductions.

Write for Samples
H. W. ACTON CO., Inc., 370 7th Ave., New York

ELECTRON TUBE PARTS

QUALITY All Types EST. 18 YEARS
Seal Finish Tungsten Welds
Tungar Welds Coil Springs
Filament Hooks Bases
Spot Welders Caps
Stem Wire Cutting & Forming Machines

"The Engineering Co." of Newark, N. J., Inc.
Daniel Kondakjian, Pres.
59 Brantford Street Newark, N. J.

UNIVERSAL 15MM. "Streamliner"
Highest quality sound pickup for p. a. recording and amateur. Crystal or dynamic in any impedance. Modern in design. Incl. loop, flex tube, screw plug and 25 ft. cable. In De Luxe package. At your jobber's now

UNIVERSAL MICROPHONE CO., LTD.
424 Warren Lane Inglewood, Calif.

PILOT LIGHTS

COMPLETE LINE OF PILOT LIGHT ASSEMBLIES FOR ALL APPLICATIONS

Write for NEW 6-PAGE CATALOGUE

MFD. BY
DIAL LIGHT CO. OF AMERICA, INC.
National Sales Agents
F. EDWIN SCHMITT SALES CO.
132 Liberty Street, New York, N. Y.

New "CONTACTS" Advertisements

must be received by Sept. 29th to appear in the October issue.

Address copy to the
Departmental Advertising Staff
ELECTRONICS
330 West 42 St., New York City

Pictures by Wire

(Continued from page 15)

coupled to the telephone line by means of coupling coils which are strapped on the bell box so as to be in line with the coils within the box. The cylinders and scanning heads are driven by a synchronous motor in each unit so as to rotate at speeds very close to each other. The motors are controlled by tuning forks which operate in constant temperature ovens. The receiving cylinder normally rotates very slightly faster than the transmitting cylinder and at the end of each revolution is stopped instantaneously until the other cylinder catches up with it by means of cams and switches on each drum and a transmitted signal for the purpose. The exposure of the negative film is controlled by the use of a constant intensity light source, the beam from which is reflected by a galvanometer mirror which vibrates according to the variations of the picture signal, thru a small opening to the film. The greater the deflection of the mirror, the less the exposure of the film. As the deflection of the mirror increases, the amount of exposure decreases.

In the International News Photo system the transmitter and receiver are combined into one instrument. The operation may be changed from transmitting to receiving, or vice versa, by throwing one switch on the scanning head. Also, this unit is small enough and light enough to be used as a portable instrument. The experience of this organization indicates that power lines are available wherever there is a telephone and so has built its equipment to operate from 110 volts ac or dc. The carrier frequency used is 1,800 cps and instead of the picture signal modulating the carrier, the carrier frequency is used to interrupt the beam from the light source so that the phototube picks up the modulated signal from the picture and it is then ready for amplification and transmission.

Synchronization is obtained by the use of a series of pulses at the beginning of each transmission and is maintained by the synchronous mo-

tor being driven by tuning fork controlled oscillators. In order to insure that an excessive signal will not be impressed upon the telephone lines, a neon glow lamp is incorporated into the circuit of the coupling unit. As long as the signal is normal, the neon lamp does not affect the operation, but as soon as the signal becomes too great, the power is absorbed by the glow lamp. The telephone lines are protected, but the quality of the picture is impaired. The transmission must then be repeated at a lower level. The coupling transformer is supplied and installed by the telephone company.

The keynote of the Wide World Photos wire transmission system is simplicity. It was designed with the idea in mind that it would be operated in most instances by photographers unfamiliar with the operation of such equipment. In this system, phasing the transmitting and receiving cylinders takes place automatically when the synchronous motor is started, with no attention from the operator. The synchronous motor of the receiver may be controlled either by a local tuning fork with a frequency of 1,800 cps, or by the carrier signal, which is also 1,800 cps, supplied by the transmitter. The tuning forks are of bi-metal construction and are temperature compensated to insure satisfactory operation over a temperature range from freezing to 110 degrees Fahrenheit. The motor of the transmitter is controlled by the same type of tuning fork as the receiver. The efficiency of the signal amplifier, motor amplifier and motor has been increased to such an extent that the transmitter may be operated from a dynamotor producing 100 ma at 300 volts.

The recording is done on a film of special characteristics manufactured by the Eastman Kodak Co. The character of the emulsion is intermediate between those of the Positive and Commercial emulsions. The emulsion is of such a nature that very fast fixing, washing and drying is possible. Important in wire transmission work is the fact that the film has a thin base so that it is easily affixed on the drum.

There are more than 40 stations located throughout the United States, Canada and Brazil. Also, at this time installations are being made in Australia.

All scales direct reading		100 kilocycles to 25 megacycles
Pushbutton range switching		Tuned MOPA circuit
Motor driven tuning		Int. & Ext. modulation to 100%
Large scale spread		Output 0.1 microvolt to 1.0 volt

A TRULY MODERN UP-TO-THE-MINUTE

STANDARD SIGNAL GENERATOR

It has all the features for speed and convenience of operation, accuracy and versatility of performance, that you've always wanted and couldn't get.

It's new — different — better

And it's the first of a complete line of precision radio frequency testing and measuring equipment. A request will bring you complete data on this generator and place you on our mailing list to receive descriptions of future instruments.

MICROVOLTS, Inc.

BOONTON, N. J.



CLARE RELAYS

ELECTRONIC INDUSTRIAL



Evidence of the value of CLARE Service and the quality of CLARE Relays is the list of prominent manufacturers and users who are regular buyers of CLARE Individualized Relays.

●

We respectfully solicit your inquiry.

CLARE Individualized Relays are designed to your specifications.

- *Coils—from a fraction ohm to 40,000 ohms—marked.
- *Contact Assemblies—makes—breaks—break-make—make before breaks—break-make before breaks and combinations of these.
- *Contacts—precision metals.
- *Residual—screw adjustable or welded fixed.
- *Adjustment—standard or to special specifications.
- *Mountings—individual or group mounting accessories.
- *Service—delivery to meet your schedules.

C. P. CLARE & CO.
 LAWRENCE & LAMON AVES. - - CHICAGO
 15 EAST 26TH STREET, NEW YORK CITY

Jewel - Point MICRODYNE



FOR more than twenty years we have been leaders in the manufacture of high grade sound reproducing equipment. Never in our history have we been called upon to supply so many pick-ups to replace other types . . . all the more gratifying, because it bears out the contention we have made for years and which leading physicists know to be a fact of science . . . that the Inductor principle is the only one that makes possible HIGH FIDELITY AND DAY-TO-DAY CONSISTENCY.

Not satisfied with FLAT response to 5,000 cycles, we have "upped" it to 6,000, then beyond 8,000 . . . so that today, with MICRODYNE, you can be as confident of the highest harmonics as of any ordinary sound in the midrange . . . AUDAX has taken still other forward steps—easily maintaining its world-wide reputation as

**"The Standard by Which Others are
Judged and Valued"**

The latest AUDAX development—a HIGH FIDELITY JEWEL-POINT MICRODYNE . . . With sufficient output to operate with any good amplifier. This new JEWEL-POINT MICRODYNE has *everything*; investigate this latest AUDAX achievement.

MICRODYNE—*regardless of climatic conditions—delivers consistently uniform response with the sharp, clean-cut definition of the finest Magneto-Inductive Pick-Up . . . yet, for all its superlative quality, COSTS NO MORE THAN THE ORDINARY PICK-UP.*

LIST PRICES START AT

\$12.50

WRITE FOR NEW LITERATURE ON PICK-UPS AND CUTTERS

AUDAK COMPANY
500 Fifth Ave. New York City

*"Creators of High Grade Electrical and
Acoustical Apparatus Since 1915"*

INDEX TO ADVERTISERS

Acheson Colloids Corp.	65
Acton Co., Inc., H. W.	90
Aerovox Corp.	89
Alden Products Co.	83
Allied Control Co.	87
Allied Recording Pds. Co.	68
American Automatic Electric Sales Co.	64
American Lava Corp.	52
American Transformer Co.	6
Astatic Microphone Laboratory, Inc.	79
Audak Co.	92
Autocall Co.	71
Bakelite Corp.	4
Ballantine Laboratories, Inc.	73
Benwood Linze Co.	90
Biddle Co., James G.	79
Bliley Electric Co.	75
Boston Insulated Wire & Cable Co.	84
Brand & Co., William	75
Callite Products Division	78
Cannon Elec. Development Co.	77
Carborundum Co., Global Div.	62
Carter Motor Co.	70
Centralab Div., Globe-Union, Inc.	2
Cincaudagraph Corp.	63
Cinch Manufacturing Co.	37
Clare & Co., C. P.	91
Clough-Bronie Co.	85
Continental Electric Co.	75
Continental-Diamond Fibre Co.	56
Cornell-Dubilier Elec. Corp.	49
Cross, H.	90
Dial Light Co. of America	90
Doolittle & Falkner	81
Drake Mfg. Co.	89
Driver Co., Wilbur B.	65
Du Mont Laboratories, Inc., Allen B.	73
Eicor Co.	90
Eisler Engineering Co.	90
Eitel-McCullough, Inc.	48
Electrical Research Products, Inc.	66
Engineering Co. of Newark, N. J., Inc.	90
Erie Resistor Corp.	61
Ferranti Electric, Inc.	42
Ferris Instrument Corp.	86
Ferrocort Corp.	84
Finch Telecommunications, Inc.	65
Formica Insulation Co.	59
Garrard Sales Corp.	85
General Control Co.	83
General Radio Co.	39
Goat Radio Tube Parts, Inc.	64
Guardian Electric Mfg. Co.	78
Guthman Co., E. I.	68
Heintz & Kaufman, Ltd.	87
Hunter Pressed Steel Co.	70
International Nickel Co.	8
International Resistance Co.	51
Isolantite, Inc.	41
Johnson Co., E. J.	85
Jones, Howard B.	89
Kurman Electric Co.	77
Lampkin Laboratories	90
Lapp Insulator Co.	5
Leach Relay Co.	87
Lenz Electric Mfg. Co.	Third Cover
Lingo & Son, Inc., John E.	76
Littelfuse, Inc.	71
Mallory & Sons, P. R.	10
McGraw-Hill Book Co.	87
Mica Insulator Co.	67
Microvolts, Inc.	91
Micro-Switch Corp.	3
Ohmite Manufacturing Co.	58
Par-Metal Products Corp.	69
Pioneer Gen.-E-Motor Corp.	79
Precision Apparatus Corp.	84
Precision Paper Tube Co.	70
Presto Recording Corp.	80
Radio City Products Co.	82
Radio Wire Television Inc.	7, 74
Raytheon Mfg. Co.	82
RCA Communications, Inc.	86
RCA Manufacturing Co.	74, Fourth Cover
Recoton Corp.	67
Richardson Co.	50
Shalleross Mfg. Co.	40
Sigma Instruments, Inc.	83
Simpson Electric Co.	77
Sola Electric Co.	69
Solar Mfg. Corp.	Second Cover
Spier Carbon Co.	55
Stackpole Carbon Co.	9
Superior Tube Co.	43
Thomas & Skinner Steel Pds. Co.	81
Triplett Electrical Instrument Co.	71
Tubular Rivet & Stud Co.	66
United Transformer Corp.	44
Universal Microphone Co.	90
Vacutron, Inc.	90
Ward Leonard Electric Co.	54
Webster Electric Co.	81
Western Electric Co.	87
Westinghouse Electric & Mfg. Co.	46, 47
Weston Electrical Instrument Corp.	53
White Dental Mfg. Co., S. S.	45
Professional Services	74
SEARCHLIGHT SECTION (Classified Advertising)	
EMPLOYMENT	88
HOME-STUDY COURSE Capitol Radio Engineering Institute	88
EQUIPMENT FOR SALE Eisbert Manufacturing Co., Inc.	88
Eisler Electric Corp.	88
Eisler Engineering Co.	88
Kahle Engineering Corp.	88
Sun Radio Co.	88

ANOTHER NEW LENZ DEVELOPMENT

Code Lenzglas

A FLAMEPROOF GLASS THREAD INSULATED WIRE

PATENT APPLIED FOR

**"INSULATION WILL NOT
SUPPORT COMBUSTION
EVEN WHEN CONDUCTOR
IS HEATED TO
INCANDESCENCE"**

FOR USE IN WIRING HOME, AUTO AND AIRCRAFT RECEIVERS AND TRANSMITTERS

CHARACTERISTICS

High Insulation Resistance
High Voltage Breakdown
Low Power Factor at High Frequencies
High Dielectric Characteristics, especially under conditions of extreme humidity
Non-Hygroscopic
Absolutely Flameproof thru-out
Good Mechanical Stripping and Push-back characteristics
Neutral pH count (Non-Electrolytic)

CODE-LENGLAS offers the engineer every desirable electrical and mechanical characteristic PLUS its new and revolutionary FLAMEPROOF quality. It is an *improved* FIBERGLAS thread insulated wire, coated with a highly plastic, flameproof high dielectric and non-hygroscopic compound.

CODE-LENGLAS fills a long felt want for an absolutely flameproof, heat-resistant wire, without sacrificing a single desirable quality or characteristic. Samples for inspection and test are available on request.

FIBERGLAS insulated wires can be furnished in 14 to 22 B & S Ga. in solid or stranded conductors, with color coded insulation.

WRITE FOR SAMPLE TODAY

**LENZ ELECTRIC
MANUFACTURING CO.**

1751 N. Western Ave.
CHICAGO U. S. A.

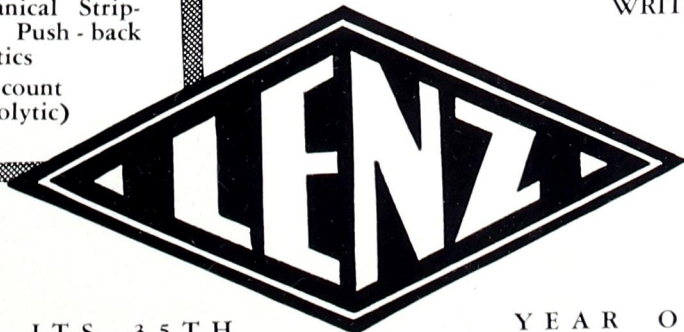

ENJOYING ITS 35TH

YEAR OF SUCCESSFUL BUSINESS

ELECTRONICS — September 1939

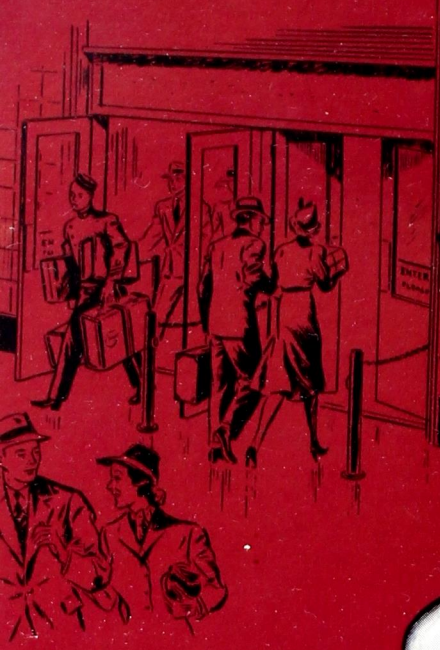

Stability PLUS Dependability ON DIRECT OPERATION from a Phototube

One Tube
DOES THE WORK
OF TWO

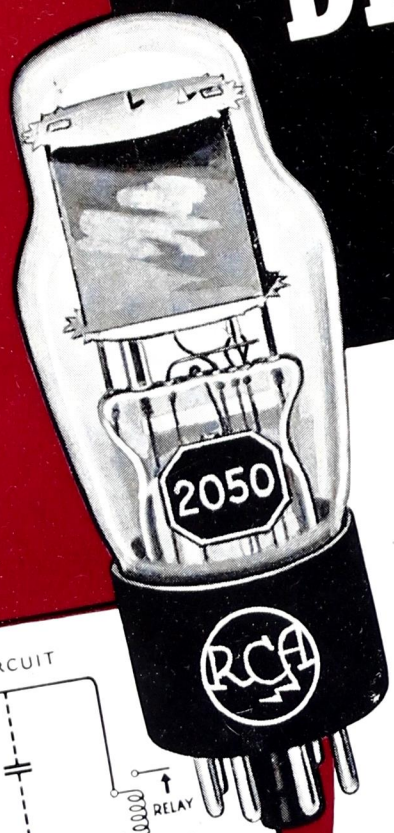

... With the New RCA HOT-CATHODE GAS TETRODES

Having extreme sensitivity and outstanding stability over a wide range of anode voltage, the new RCA-2050 and RCA-2051 gas-filled tetrode tubes of the indirectly heated, hot-cathode type, pave the way for important savings in grid-controlled rectifier and relay applications. They are particularly adapted for use in control devices actuated either by phototubes or radio signals.

Grid current is extremely low, permitting high grid resistance to be used in the grid circuit. The resulting high sensitivity permits the tube to be operated directly by a vacuum-type phototube, as shown in Diagram No. 1, thus eliminating one or more tubes previously required in conventional circuits (Diagram No. 2).

The control characteristic is very steep, having a control ratio of approximately 325. Only low values of grid-bias voltage are required. A very small grid-anode capacitance makes the tubes insensitive to line voltage surges and minimizes the undesirable effect of capacitance current flowing through the grid resistance.

Now ready for delivery, the tubes are detailed in an engineering folder available from RCA Commercial Engineering Section, Harrison, N. J.

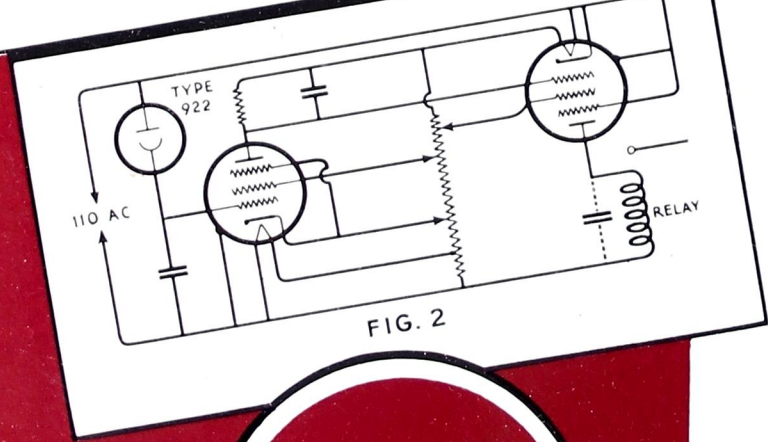
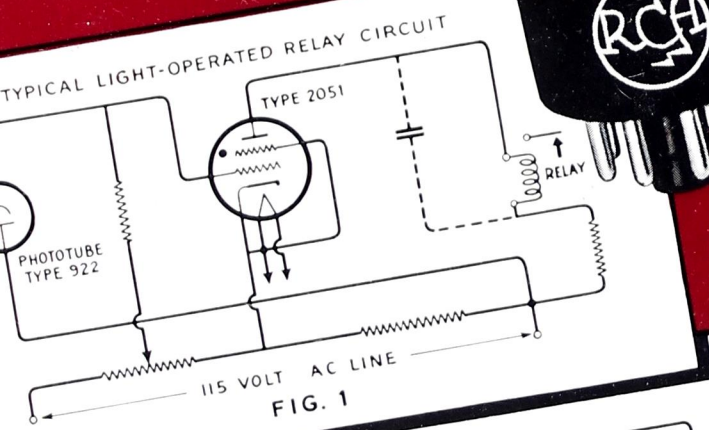

RCA-2050—Used to control up to 650 volts peak and will handle a peak current of 500 ma. and an average current of 100 ma.

RCA-2051—Used to control up to 350 volts peak and will handle a peak current of 375 ma. and an average current of 75 ma.

The above illustration of RCA-2050 is approximately actual size. Each tube has small, ST-12 bulb, uses standard octal base and is of extremely rugged construction.

CHARACTERISTICS

	Type 2050	Type 2051
HEATER VOLTAGE	6.3	6.3 Volts
HEATER CURRENT	0.6	0.6 Amperes
PEAK ANODE VOLTAGE (Max.)	650	350 Volts
PEAK ANODE CURRENT (Max.)	500	375 Ma.
AVERAGE ANODE CURRENT (Max.)	100	75 Ma.
GRID RESISTOR (Max.)	10	10 Megohms

Visit RCA Television Exhibits at Golden Gate International Exposition and New York World's Fair.



Radio Tubes

RCA MANUFACTURING CO., INC., CAMDEN, N. J.
A Service of The Radio Corporation of America

FIRST IN METAL—FOREMOST IN GLASS—FINEST IN PERFORMANCE